

Intelligent Component Series ACTIVAL™ Motorized Two-Way Valve with Flanged-End Connection (JIS 10K / FC200, SCS13A)

■ General

ACTIVAL™ Model VY516XJ is a series of motorized two-way valves with flanged-end connection. Rotary valve and actuator are integrated in a single unit.

Valve size ranges from DN15 (1/2") to DN80 (3"), and valve body rating corresponds to JIS 10K.

Actuator has a reversible synchronous motor, which operates at a low voltage of 24 V AC.

Model VY516XJ communicates with a controller via SAnet (Azbil Corporation's communication protocol).

* Note

JIS: Japanese Industrial Standards



■ Features

- Compact and lightweight:
Rotary valve actualizes small body and light weight.
- Valve and actuator integrated in a single unit.
- SAnet communication:
Intelligent Component Series ACTIVAL communicates with a controller via SAnet, and thus position control signal/position feedback signal is input/output from/to the controller.
- Valve for chilled/hot water control and for steam control applicable to large Cv value, high rangeability, and low leakage.
- Durable actuator with low power consumption.
- Equal percentage flow characteristic.
- Sub-DI and sub-DO for wire saving:
Sub-DIO (digital input and output) provided takes signals, including humidifying output and differential pressure switch of neighboring devices, leading to wire saving.



Safety Instructions

Please read instructions carefully and use the product as specified in this manual. Be sure to keep this manual nearby for quick reference.







Usage Restrictions







This product is targeted for general air conditioning. Do not use this product in a situation where human life may be affected. If this product is used in a clean room or a place where reliability or control accuracy is particularly required, please contact our sales representative. Azbil Corporation will not bear any responsibility for the results produced by the operators.















Warnings and Cautions

	WARNING Alerts users that improper handling may cause death or serious injury.
	CAUTION Alerts users that improper handling may cause minor injury or material loss.

Signs

	Alerts users possible hazardous conditions caused by erroneous operation or erroneous use. The symbol inside  indicates the specific type of danger. (For example, the sign on the left warns of the risk of electric shock.)
	Notifies users that specific actions are prohibited to prevent possible danger. The symbol inside  graphically indicates the prohibited action. (For example, the sign on the left notifies that disassembly is prohibited.)
	Instructs users to carry out a specific obligatory action to prevent possible danger. The symbol inside  graphically indicates the actual action to be carried out. (For example, the sign on the left indicates general instructions.)

 WARNING	
	When handling or transporting any heavy product (more than 18 kg), carefully move the product with a hand truck or the like, or with 2 or more people. Careless lifting or accidental dropping of the product may result in injury or product damage.
	Before wiring, setting, maintenance, or replacement, be sure to turn off the power to this product. Failure to do so may result in electric shock or device failure.
	Be sure to ground this product with a ground resistance of less than 100 Ω. Improper grounding may cause electric shock or malfunction.
	After wiring, setting, engineering, maintenance, or replacement work, be sure to reattach the cover. Failure to do so may result in electric shock.
	Before setup or engineering work, be sure to turn off power that is supplied from external devices to the output terminals. Failure to do so may cause electric shock.

 CAUTION	
	Provide a circuit protector (e.g., a fuse or circuit breaker) for the power source. Failure to do so may cause a short circuit leading to fire or device failure.
	Do not freeze this product. Doing so may damage the valve body and cause leakage.
	When piping this product, be sure there is no foreign matter in the pipes. If foreign matter remains in the pipes, the product may break down.
	Install, wire, and use this product under the conditions specified by this manual. Failure to do so may cause fire or device failure.
	Use full face gaskets for flat face flanges. Failure to do so may damage the flanges or cause leakage outside of the valve.
	When installing this product, hold it in the proper position and securely fasten it to the pipes. Excessive tightening or improper installation position may damage the valve.
	After installation, make sure no fluid leaks from the valve-pipe connections. Improper piping may cause fluid leakage outside of the valve.
	Do not put a load or weight on this product. Doing so may damage the product.
	Installation and wiring of the actuator must be performed by personnel qualified to do instrumentation and electrical work. Mistakes in installation or wiring may cause fire or electric shock.
	All wiring must comply with applicable codes and ordinances. Otherwise there is a danger of fire.
	Use crimp terminals with insulation for connections to the product terminals. Failure to do so may cause short circuit leading to fire or device failure.
	Tighten the terminal screws with the specified torque. Insufficient tightening of the terminal screws may cause fire or overheating.
	Before setup or engineering work, be sure to turn off power that is supplied from external devices to the output terminals. Failure to do so may cause electric shock..
	Do not carelessly touch this product when it is used to control hot water. Doing so may result in burns, because the product reaches a high temperature.

■ System Configurations

● Connection example of savic-net™ G5 system

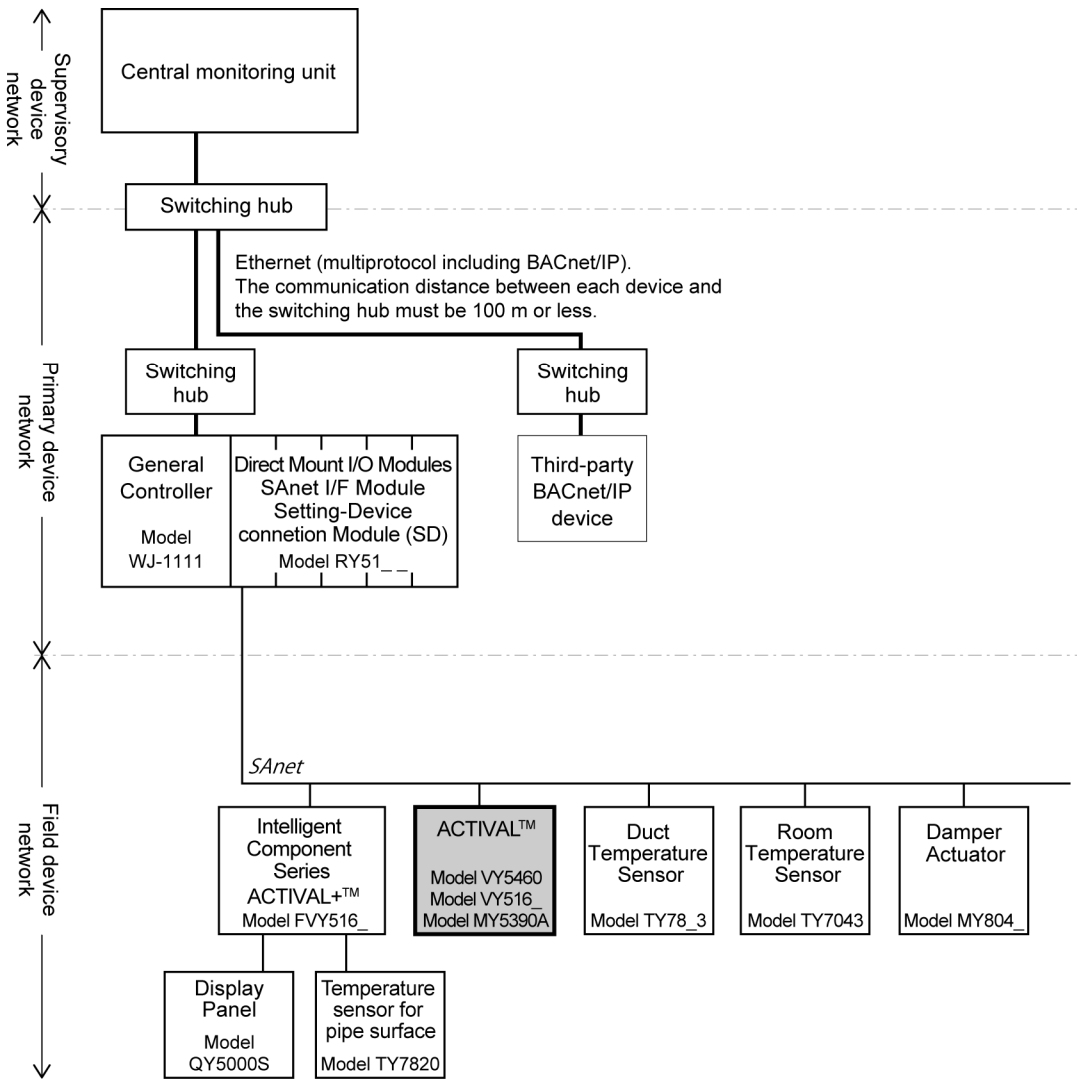

Figure 1. System configuration example: SAnet connection in savic-net™ G5 system

● Connection example of savic-net™ FX system

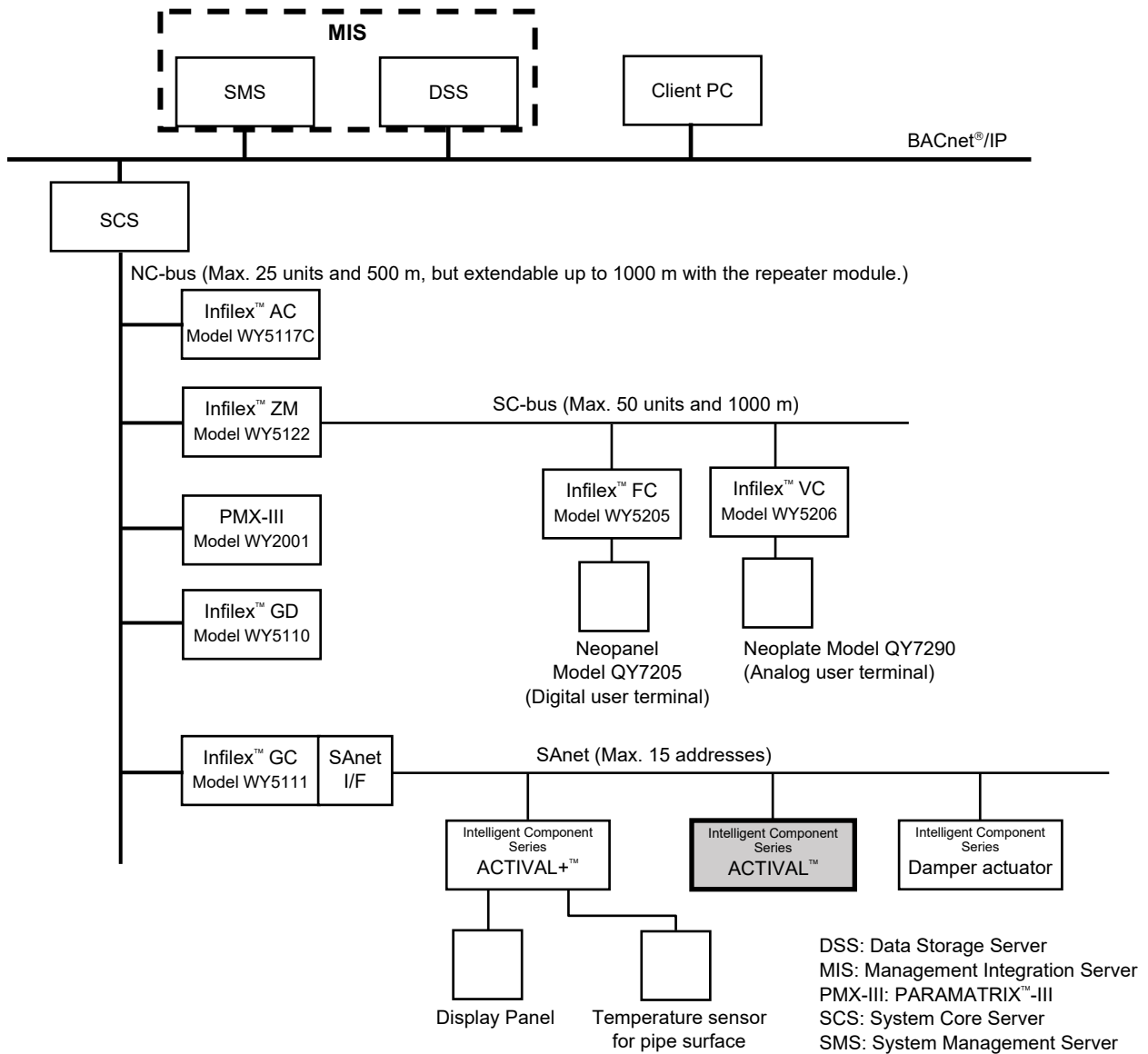

Figure 2. System configuration example: SAnet connection in savic-net™ FX system

Notes:

- * MIS may be used instead of SMS and DSS for your system. Note that MIS cannot be mixed with SMS or DSS in the same system.
- * Up to two SAnet I/F modules can be connected to one General Controller or InflexGC/InflexGD.
- * For detailed specifications of SAnet, refer to Installation Manual of Intelligent Component Series for SAnet Communication (AB-6713).
- * 1 ACTIVAL or 1 damper actuator requires 1 SAnet address. 1 ACTIVAL+ requires 2 SAnet addresses.

■ Model Numbers

Model VY516XJ00XX is the model for the valve and actuator integrated into a single unit.
The model number label is attached to the yoke.

Base model number	Actuator control signal	Valve rating/material	Actuator type	—	Valve size/Cv	—	Description
VY51							Motorized two-way valve with flanged-end connection
	6						SAnet
		0					JIS 10K / JIS FC200
		1					JIS 10K / JIS SCS13A
		5					JIS 10K / JIS FC 200 [for steam]
		6					JIS 10K / JIS SCS13A [for steam]
			J				IEC IP54 protected and standard torque type actuator with terminal block (Mountable valve sizes: DN15 to DN80)
				00			Fixed
					11		DN15 (1/2") / 1.0 in Cv value
					12		DN15 (1/2") / 2.5 in Cv value
					13		DN15 (1/2") / 6.0 in Cv value
					14		DN15 (1/2") / 1.6 in Cv value
					15		DN15 (1/2") / 4.0 in Cv value
					21		DN25 (1") / 10 in Cv value
					22		DN25 (1") / 16 in Cv value
					41		DN40 (1 1/2") / 25 in Cv value
					42		DN40 (1 1/2") / 40 in Cv value
					51		DN50 (2") / 65 in Cv value
					61		DN65 (2 1/2") / 95 in Cv value
					81		DN80 (3") / 125 in Cv value
						-B	Fixed

● Options

For options, separate order is required.

Item		Specification	Note	
Seal connector	Part No. 83104346-003	Applicable wire size: ϕ 7 mm to ϕ 9 mm	Seal connector is necessary for IEC IP54 protection.	
	Part No. 83104346-004	Applicable wire size: ϕ 9 mm to ϕ 11 mm		
	Part No. 83104346-005	Applicable wire size: ϕ 11 mm to ϕ 13 mm		
Seal connector for SAnet cable gland	Part No. 83104346-012	Applicable wire size: ϕ 6 mm to ϕ 8 mm	Seal connector for SAnet cable gland with three ports is necessary for IEC IP54 protection.	
	Part No. 83104346-013	Applicable wire size: ϕ 7 mm to ϕ 9 mm		
	Part No. 83104346-014	Applicable wire size: ϕ 9 mm to ϕ 11 mm		
SAnet cable gland with three ports Part No. DY7000A1000		For the specifications of SAnet cable gland with three ports, refer to the Specifications (AS-923E). For the installation of SAnet cable gland with three ports, refer to the Installation Manual of Intelligent Component Series for SAnet Communication (AB-6713).		
Outdoor cover Part No. DY3001A1017		Required when the product is installed outdoors.		
Valve flange adapter kit (for replacing Model V5063/V5064 with Model VY51XX)		Hot-rolled steel (JIS SS4400), electro-galvanized/not electro-galvanized		
		Electro-galvanized	Not electro-galvanized	Applicable valve size
		Part No. 83168456-001	Part No. 83168456-101	DN15
		Part No. 83168456-002	Part No. 83168456-102	DN25
		Part No. 83168456-003	Part No. 83168456-103	DN40
		Part No. 83168456-004	Part No. 83168456-104	DN50
		Part No. 83168456-005	Part No. 83168456-105	DN65
Part No. 83168456-006	Part No. 83168456-106	DN80		

■ Specifications



For weight, refer to the table shown in the section **Dimensions**.

● Valve specifications

Item	Specification			
Model	Two-way valve with flanged-end connection, proportional control			
Body pressure rating	JIS 10K (Max. pressure: 1.0 MPa)			
Size, Cv, Close-off rating Note: Close-off ratings of the actuator in combination are shown on the right. Practical close-off rating required for the valve controlling 175 °C steam is 0.8 MPa.	Model number	Nominal size	Cv	Close-off ratings
	VY516XJ0011	DN15 (1/2")	1.0	1.0 MPa
	VY516XJ0012	DN15 (1/2")	2.5	1.0 MPa
	VY516XJ0013	DN15 (1/2")	6.0	1.0 MPa
	VY516XJ0014	DN15 (1/2")	1.6	1.0 MPa
	VY516XJ0015	DN15 (1/2")	4.0	1.0 MPa
	VY516XJ0021	DN25 (1")	10	1.0 MPa
	VY516XJ0022	DN25 (1")	16	1.0 MPa
	VY516XJ0041	DN40 (1 1/2")	25	1.0 MPa
	VY516XJ0042	DN40 (1 1/2")	40	1.0 MPa
	VY516XJ0051	DN50 (2")	65	1.0 MPa
	VY516XJ0061	DN65 (2 1/2")	95	1.0 MPa
VY516XJ0081	DN80 (3")	125	0.7 MPa	
Materials	Body	Gray cast iron (equivalent to JIS FC200) for Models VY5160, VY5165 Cast stainless steel (equivalent to JIS SCS13A) for Models VY5161, VY5166		
	Plug, stem	Stainless steel (equivalent to JIS SCS)		
	Seat ring	Heat-resistant PTFE		
	Gland packing	Inorganic fiber		
	Gasket	Non-asbestos joint sheet		
End connection	JIS 10K flanged-end, flat face flange (FF) for Models VY5160, VY5165 raised face flange (RF) for Models VY5161, VY5166			
Applicable fluid	Chilled/hot water, high temperature water, steam, brine (ethylene glycol solutions, 50 % max.)			
Allowable fluid temperature	0 °C to 175 °C* (Non-freezing)			
Flow characteristic	Equal percentage			
Rangeability	100 : 1			
Leakage from valve seat	0.01 % of rated Cv value (0.0006 Cv or less for DN15 model)			
Paint color	Gray (equivalent to Munsell 5B 4/1): Models VY5160, VY5165 (Gray cast iron valve body) Unpainted: Models VY5161, VY5166 (Cast stainless steel valve body)			
Actuator mounting	Integrated with the valve			

* Note: To use the stainless steel valve for fluid of temperature below 0 °C, consult with our sales personnel.

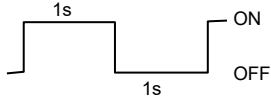
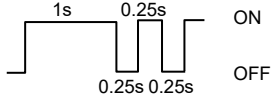
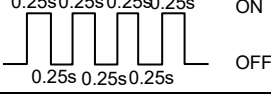
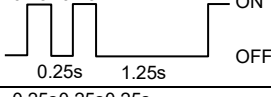
● Actuator specifications

Item		Specification	
Power supply		24 V AC ± 15 %, 50 Hz/60 Hz	
Power consumption		10 VA	
Valve travel time		63 ± 5 s (50 Hz) / 53 ± 5 s (60 Hz)	
Control signal		SAnet	
Sub-DI (contact input)	Input type	Potential free (dry) contact input	
	Voltage, current	20 V DC, 5 mA (* Unlike Models VY516XK, VY516XH, this product does not have forced shutoff DI.)	
Sub-DO (contact output)	Output type	Potential free (dry) contact output	
	Contact rating	200 V AC/24 V DC, Max. 0.5 A (2 A at startup)	
	Min. applicable load	24 V DC, 5 mA	
LED indication		Description	
Initializing		Continuous ON → LED indication corresponding to the operating status (after initializing is complete.)	
Normal		Repetition of 1-second ON → 1-second OFF.	
Major alarm		Continuous ON.	
Minor alarm		Repetition of 1-second ON → 0.25-second OFF → 0.25-second ON → 0.25-second OFF.	
Communication error (and minor alarm)		Repetition of 0.25-second ON → 0.25-second OFF	
Manual operation		Repetition of 0.25-second ON → 0.25-second OFF → 0.25-second ON → 1.25-second OFF.	
Error during manual operation		Repetition of 0.25-second ON → 0.25-second OFF → 0.25-second ON → 0.25-second OFF → 0.25-second ON → 0.75-second OFF.	
Communication (via SAnet)	Transmission system	Voltage transmission (SAnet)	
	Transmission speed	1200 bps	
	Transmission distance	Transmission distance varies depending on the number of devices and the type of devices to be connected to. For details on the transmission distance, refer to Installation Manual of Intelligent Component Series for SAnet Communication (AB-6713).	
Materials	Case	Die cast aluminum	
	Top cover, terminal cover	Polycarbonate resin (Color: gray)	
	Yoke	Steel plate	
Surface finishing	Case	None	
	Yoke	Electro-galvanized (Bright chromate finish)	
Valve position indication		Pointer located at the bottom of the actuator shows the position by pointing at the value of the scale (0: close to 100: open) on front, rear, and bottom sides.	
Manual operation		Available. Refer to the section Manually opening/closing the ACTIVAL.	
Wiring		M3.5 screw terminals	
Enclosure protection		IEC IP54 (dust-proof and splash-proof)	
Insulation resistance		Between terminal and case: 5 MΩ or higher at 500 V DC	
Withstand voltage		Between terminal and case: 500 V AC/min with 5 mA or less leakage current	

● Valve and actuator (as a single unit) specifications

Item	Specification		
	Rated operating condition	Limit operating condition	Transport/storage conditions (packaged*2)
Operating conditions	Ambient temperature*1	-20 °C to 50 °C (Fluid temperature 0 °C to 150 °C)	-20 °C to 60 °C
		-20 °C to 40 °C (Fluid temperature 150 °C to 175 °C)	-20 °C to 70 °C
	Ambient humidity	5 %RH to 95 %RH	
Vibration	4.9 m/s ² (10 Hz to 150 Hz)	9.8 m/s ² (10 Hz to 150 Hz)	19.6 m/s ² (10 Hz to 150 Hz)
Notes: *1 Do not allow the fluid to freeze. *2 Actuator shall be packed during transport and storage.			
Installation locations	Indoor / outdoor (Keep away from direct sunlight.) Note: Salt air, corrosive gas, flammable gas, and organic solvent must be avoided.		
Mounting position	Refer to ■ "Installation," ● "Mounting position."		
Factory preset position	100 % (fully open) preset at factory.		

● Function

Function	Specification
Data monitoring	Following items can be monitored/operated from the host system (savic-net FX), General Controller (model WJ-1111), and Inflex GC/Inflex GD Valve position setting, valve position measuring, sub-DO output, sub-DI monitoring

* Note:

Above function is available in combination with General Controller (model WJ-1111), Inflex GC/Inflex GD, and savic-net FX.

● Wire specifications

For details regarding specifications of SAnet communication line (24 V (~), GND (⊥), SAnet), refer to the Installation Manual of SAnet for Intelligent Component Series (AB-6713).

Item	Specification	Length
Contact input (sub-DI)	JIS CVV, JIS VCT, JIS IV, KPEV for low power 0.75 mm ² , 0.9 mm ² , 1.25 mm ² , 2.0 mm ²	30 m
Contact output (sub-DO)	JIS CVV, JIS VCT, JIS IV, KPEV for low power 0.75 mm ² , 0.9 mm ² , 1.25 mm ² , 2.0 mm ²	30 m

Note

* KPEV: Wire standard provided by Furukawa Electric Co., Ltd.

■ Dimensions

● Models VY5160J, VY5165J

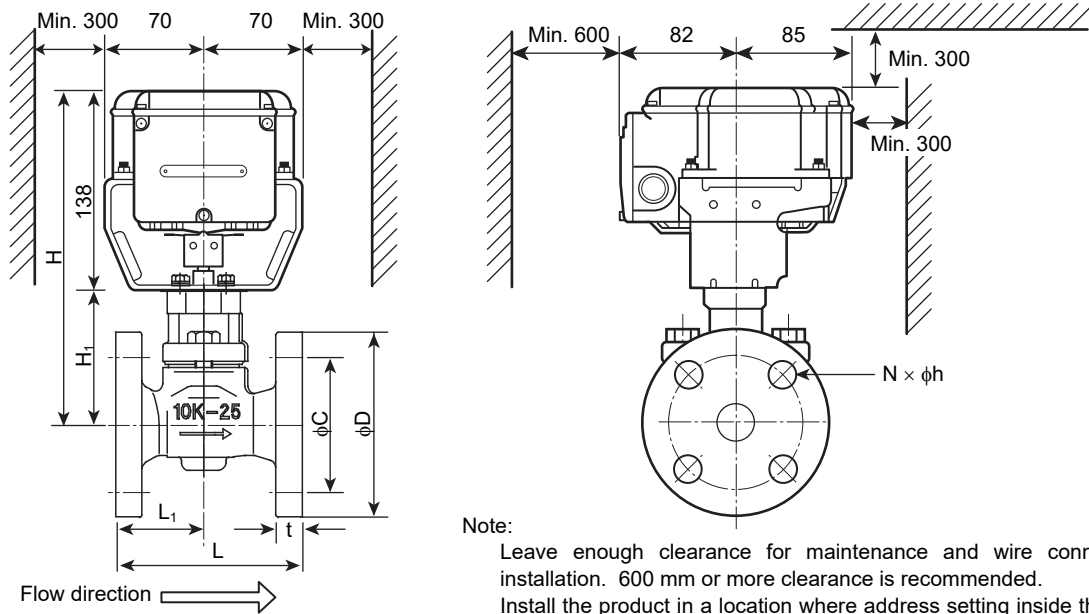

Note:
 Leave enough clearance for maintenance and wire connection after installation. 600 mm or more clearance is recommended.
 Install the product in a location where address setting inside the cover can visually be checked.

Model number	Valve size (DN)	H (mm)	H ₁ (mm)	L (mm)	L ₁ (mm)	t (mm)	φC (mm)	φD (mm)	φh (mm)	N	Weight (kg)
VY5160J001X VY5165J001X	15	213	75	108	50	16	70	95	15	4	4.6
VY5160J002X VY5165J002X	25	228	90	127	60	18	90	125	19	4	6.6
VY5160J004X VY5165J004X	40	241	103	165	82.5	20	105	140	19	4	10.0
VY5160J0051 VY5165J0051	50	245	107	178	89	20	120	155	19	4	11.5
VY5160J0061 VY5165J0061	65	262	124	190	90	22	140	175	19	4	16.0
VY5160J0081 VY5165J0081	80	263	125	203	100	22	150	185	19	8	18.5

Figure 3. Dimensions and maintenance clearance (mm): Models VY5160J, VY5165J

● Models VY5161J, VY5166J

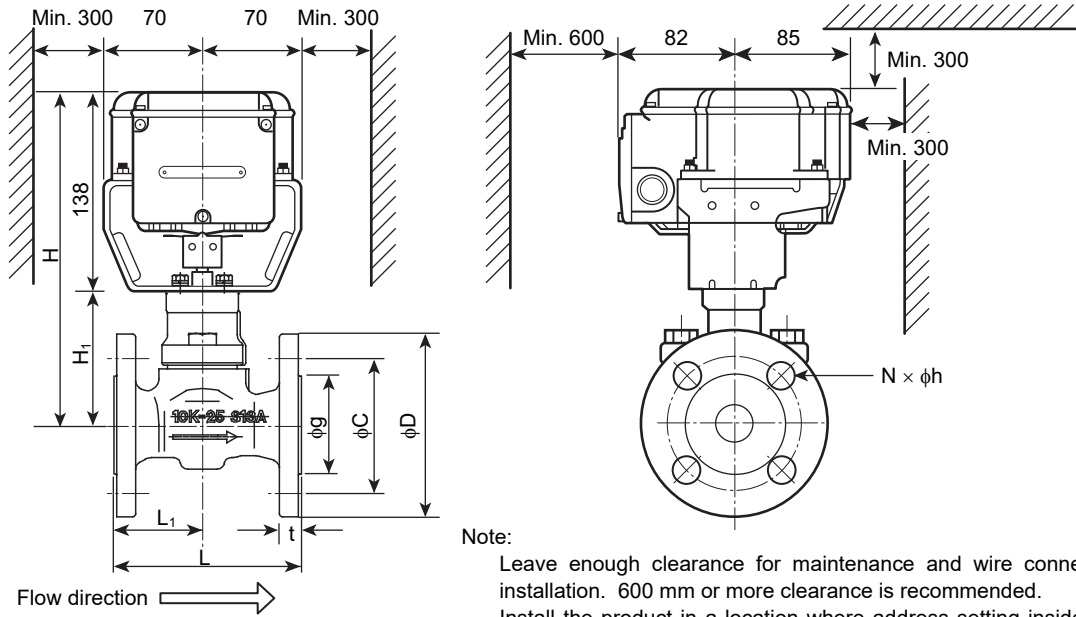

Model number	Valve size (DN)	H (mm)	H ₁ (mm)	L (mm)	L ₁ (mm)	t (mm)	φC (mm)	φD (mm)	φg (mm)	φh (mm)	N	Weight (kg)
VY5161J001X VY5166J001X	15	213	75	108	50	12	70	95	51	15	4	4.6
VY5161J002X VY5166J002X	25	228	90	127	60	14	90	125	67	19	4	6.6
VY5161J004X VY5166J004X	40	241	103	165	82.5	16	105	140	81	19	4	10.0
VY5161J0051 VY5166J0051	50	245	107	178	89	16	120	155	96	19	4	11.5
VY5161J0061 VY5166J0061	65	262	124	190	90	18	140	175	116	19	4	16.0
VY5161J0081 VY5166J0081	80	263	125	203	100	18	150	185	126	19	8	18.5

Figure 4. Dimensions and maintenance clearance (mm): Models VY5161J, VY5166J

■ Parts Indication

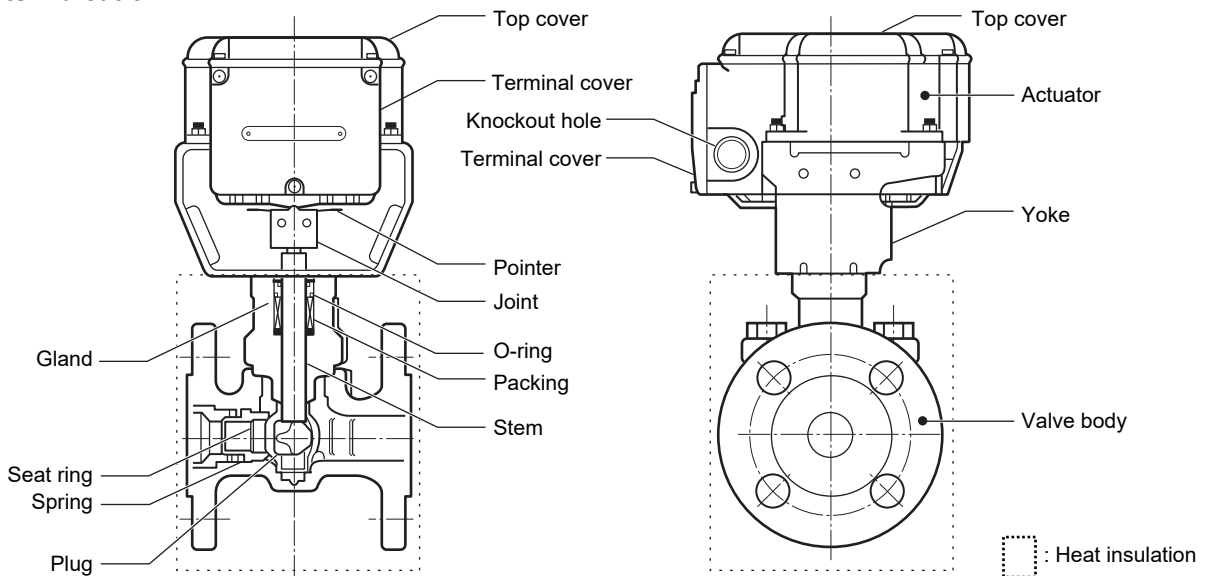

Figure 5. Parts indication

■ Installation

● Precautions for installation

WARNING



When handling or transporting any heavy product (more than 18 kg), carefully move the product with a hand truck or the like, or with 2 or more people.
Careless lifting or accidental dropping of the product may result in injury or product damage.

CAUTION



Do not freeze this product.

Doing so may damage the valve body and cause leakage.



When piping this product, be sure there is no foreign matter in the pipes.

If foreign matter remains in the pipes, the product may break down.



Install, wire, and use this product under the conditions specified by this manual.

Failure to do so may cause fire or device failure.



Use full face gaskets for flat face flanges.

Failure to do so may damage the flanges or cause leakage outside of the valve.



Installation and wiring of the actuator must be performed by personnel qualified to do instrumentation and electrical work.

Mistakes in installation or wiring may cause fire or electric shock.

- ACTIVAL Model VY516XJ is the valve and actuator integrated into a single unit. Do not combine the valve with any other actuator, or do not combine the actuator with any other valve.
- To remove foreign substances inside the pipes, install a strainer with 40 or more meshes (with 80 or more meshes recommended for steam control) on the inflow side of each valve. In case that the strainers cannot be installed on the inflow side of each valve, install it on the pipe diverting sections (sections diverting from main piping system to sub piping system).
- Install the valve so that the flow direction of process fluid agrees with the arrow indicated on the valve body.

● Installation location

IMPORTANT:

- The top and the terminal covers might be corroded by chemicals and organic solvent or their vapor. Do not expose the ACTIVAL to such substances/vapor.
- When the ACTIVAL is used for steam humidifying, install a valve interlocking with air-conditioning unit on the inflow side in case the ACTIVAL gets damaged.
- Although the ACTIVAL can be used in high humidity environments (max. 95 %RH), do not immerse the actuator in water.
- Although the ACTIVAL can be used outdoors, be sure not to expose the ACTIVAL to direct sunlight.
- Position the pipes so that drainage does not accumulate next to the valve.
If there is remaining drainage, the valve or pipes may be damaged by steam hammer or corrosion.
Install a trap so that drainage does not accumulate or use a valve made of stainless steel with high erosion and corrosion resistance (JIS SCS13A).

- Install the ACTIVAL in a position allowing easy access for maintenance and inspection. Figs. 3 and 4 show the minimum clearance for maintenance and inspection. When installing the ACTIVAL in a ceiling space, provide an access hole within the 50 cm radius of the ACTIVAL. And, place a drain pan under the valve.
- Do not install the product nearby a steam coil or a hot-water (in high temperature) coil. High heat radiation may result in an actuator malfunction.
- Do not mount the ACTIVAL on a pipe where water hammer occurs, or where solid objects including slug may accumulate.

● **Mounting position**

The ACTIVAL can be mounted in any position ranging from upright to sideways (90° tilted). The ACTIVAL should be installed with its actuator vertically positioned above the valve body. (See Fig. 6.) However, the ACTIVAL must be installed always in upright position outdoors.

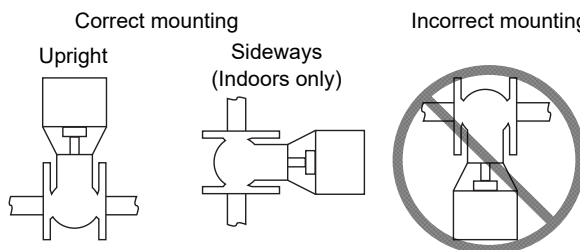

Figure 6. Mounting position

● **Piping**

⚠ CAUTION	
!	When installing this product, hold it in the proper position and securely fasten it to the pipes. Excessive tightening or improper installation position may damage the valve.

- Check that the model number of the product is what you ordered. The model number is shown on the label attached to the yoke.
- Install a bypass pipe and gate valves on the inflow, outflow, and bypass sides. Also, install a strainer with 40 or more meshes (with 80 or more meshes recommended for steam control) on the inflow side.
- When installing the ACTIVAL to the pipes, do not allow any object, such as chips, to get inside a pipe or valve. Valve cannot fully close, or the valve seat may get damaged causing fluid leakage, due to an object jammed inside the valve.
- When piping, do not apply too much sealing material, such as solidifying liquid and tape, to the pipe connection sections so that these materials flow into the valve. Valve cannot fully closes, or the valve seat may get damaged causing fluid leakage, due to the sealing material jammed inside the valve.
- Before activating the ACTIVAL, fully open (in 100 % position) the valve and flush the pipes (with the ACTIVAL installed) at the maximum flow rate to remove all the foreign substances. (Factory preset position: 100 %)
- For steam control, drain retained water (condensate) in piping. Install a trap on a pipe run which may retain condensate. Condensate may cause water hummer or damage the valve and piping.

⚠ CAUTION	
!	After installation, make sure no fluid leaks from the valve-pipe connections. Improper piping may cause fluid leakage outside of the valve.
⊘	Do not put a load or weight on this product. Doing so may damage the product.

● **Heat insulation**

Do not apply heat insulation to the actuator or to the yoke, as [] shows in Fig. 5. If the yoke and the actuator are covered with insulation material, the pointer cannot be checked and may be distorted.

● **Factory preset position**

The actuator shaft is positioned at 100 % (in fully open position) for shipment. The shaft is thus completely turned clockwise, and the pointer points at '100'. (See Fig. 7.)

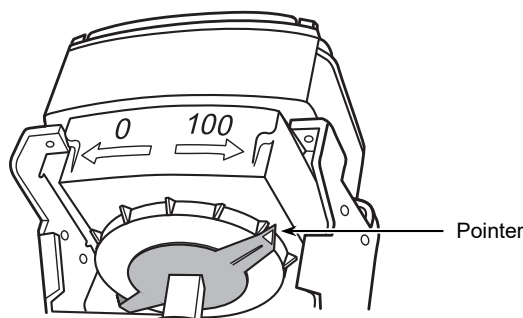

Figure 7. Pointer position for shipment

● **Manually opening/closing the ACTIVAL**

IMPORTANT:

- Manually opening/closing the ACTIVAL with the power (24 V AC) applied may damage the actuator.
- To manually open/close the ACTIVAL, do not turn the joint beyond the fully open (100)/closed (0) mark.
- To manually open/close the ACTIVAL, slowly turn the joint. If shock is sent to the actuator, the actuator may get damaged.

Disconnect the power from the ACTIVAL before manually operating the ACTIVAL. As shown in Fig. 8, from the front of the ACTIVAL, hold the joint using a tool such as a wrench, and turn the joint slowly toward the set position.

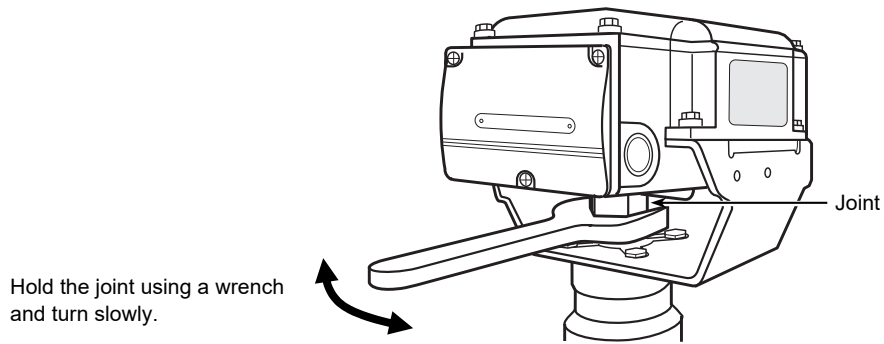

Figure 8. Manual operation

● Procedure to change the actuator mounting position

IMPORTANT:

- Do not change the combination of the valve, yoke, and actuator.
- Set the ACTIVAL (actuator and valve) in 100 % position when changing the mounting position. If the valve in 0 % position is assembled with the actuator in 100 % position, the actuator puts torque on the closed valve, and the gear of the actuator gets damaged.

- 1) Remove the screws connecting the actuator and the yoke. Lift the actuator and detach it from the yoke. Make sure that the groove on the top of the valve stem is parallel to the pipes (indicating the valve in 100 % position). <Step 1 in Fig. 9>
- 2) Remove the screws connecting the yoke and the valve. <Step 2 in Fig. 9>
- 3) Change the facing direction of the yoke. The yoke and actuator can be horizontally rotated every 90° (0°/90°/180°/270° from the factory preset position) to mount onto the valve.
- 4) A thermal insulation sheet is inserted between the yoke and the valve. When changing the mounting positions, reinsert the sheet and then fit the yoke into the new mounting position.
- 5) Before fixing the yoke to the valve with the screws, check that the actuator engages correctly with the valve stem (at the new mounting position). Check that the pointer of the actuator indicates 100 % position as well. Then, fix the yoke to the valve. <Step 3 in Fig. 9>
- 6) Mount the actuator. Place the actuator, with its facing direction changed, on the yoke, and fix them with the screws. <Step 4 in Fig. 9>
- 7) Check that the ACTIVAL with the mounting position changed operates smoothly (from 0 % to 100 %).

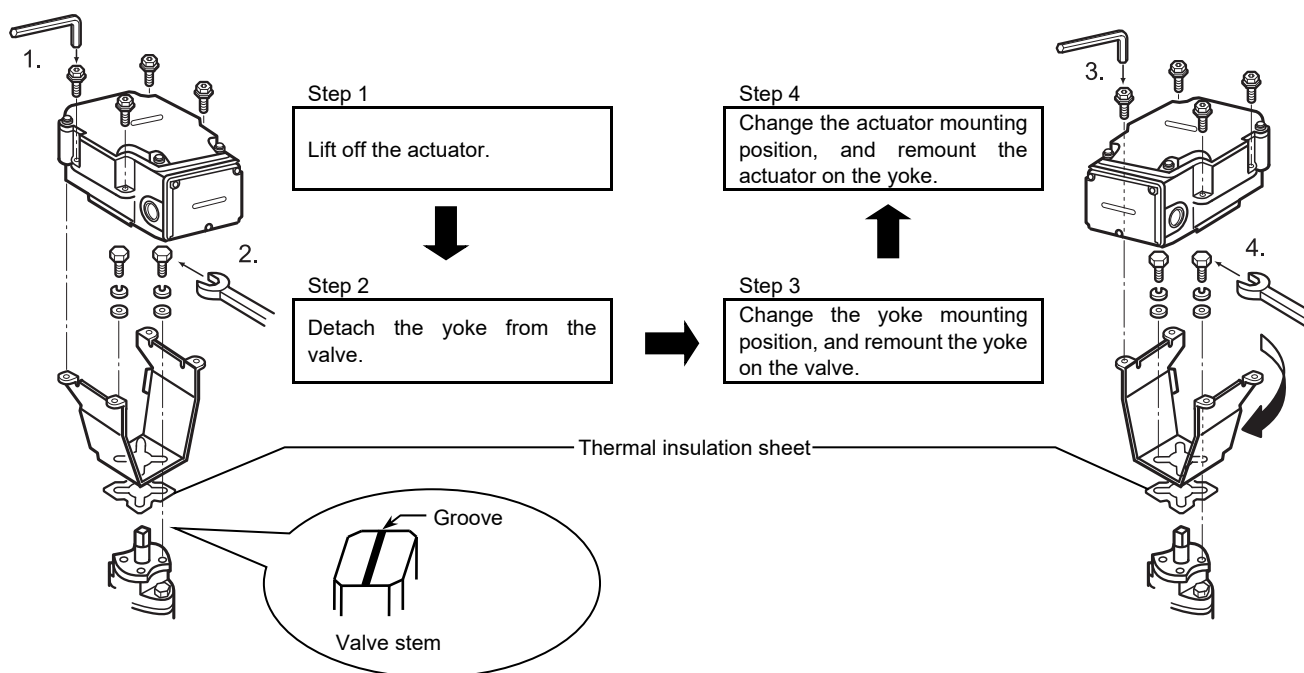

Figure 9. Changing the actuator mounting position

■ **Wiring**

⚠ WARNING	
❗	Before wiring, be sure to turn off the power to this product. Failure to do so may result in electric shock or device failure.
⚡	Be sure to ground this product with a ground resistance of less than 100 Ω. Improper grounding may cause electric shock or malfunction.
❗	After wiring, be sure to reattach the cover. Failure to do so may result in electric shock.

⚠ CAUTION	
❗	Provide a circuit protector (e.g., a fuse or circuit breaker) for the power source. Failure to do so may cause a short circuit leading to fire or device failure.
❗	Install, wire, and use this product under the conditions specified by this manual. Failure to do so may cause fire or device failure.
❗	Installation and wiring of the actuator must be performed by personnel qualified to do instrumentation and electrical work. Mistakes in installation or wiring may cause fire or electric shock.
❗	All wiring must comply with applicable codes and ordinances. Otherwise there is a danger of fire.
❗	Use crimp terminals with insulation for connections to the product terminals. Failure to do so may cause short circuit leading to fire or device failure.
❗	Tighten the terminal screws with the specified torque. Insufficient tightening of the terminal screws may cause fire or overheating.

<p>IMPORTANT:</p> <ul style="list-style-type: none"> • The ACTIVAL is designed for 24 V AC power supply voltage. Do not apply any other power voltage (e.g., 100 V AC, 200 V AC) to the ACTIVAL. • To prevent damage, cover the terminals except when connecting/disconnecting wires.
--

● **Wiring precautions**

- 1) To lead the wires into the terminals, cut out a knockout hole for a wiring port. Two knockout holes are provided on the bilateral sides of the actuator terminals. Select a knockout hole according to the conduit mounting direction, and cut it out by lightly knocking the hole using a screwdriver.

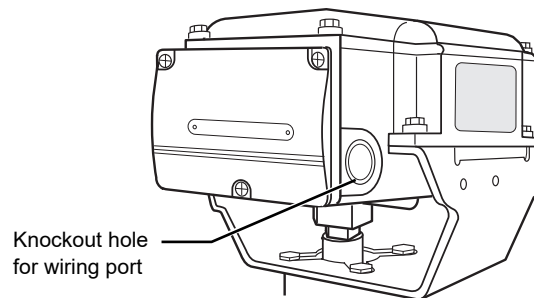

Figure 10. Knockout hole for wiring port

<p>IMPORTANT:</p> <ul style="list-style-type: none"> • Do not leave any refuse including metal chips after cutting a knockout hole and after connecting the wires inside the actuator.
--

- 2) Unscrew the 3 setscrews (M4 × 10) of the terminal cover and remove the terminal cover, as shown in Fig. 11.

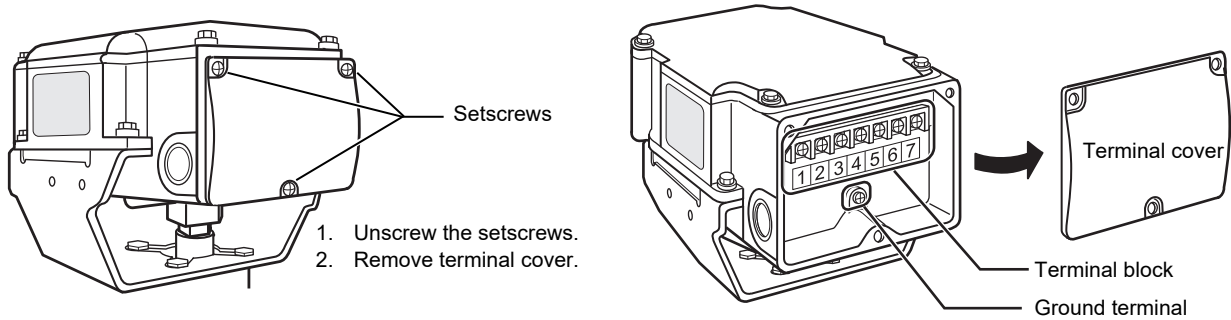

Figure 11. Terminal cover removal

- 3) Correctly connect the wires to the terminals with M3.5 screw terminal lugs, referring to Fig. 12. To connect a device with over 100 V AC to the sub-DO, be sure to ground the actuator with 100 Ω or lower ground resistance. Refer to Fig. 11 for the location of each terminal.

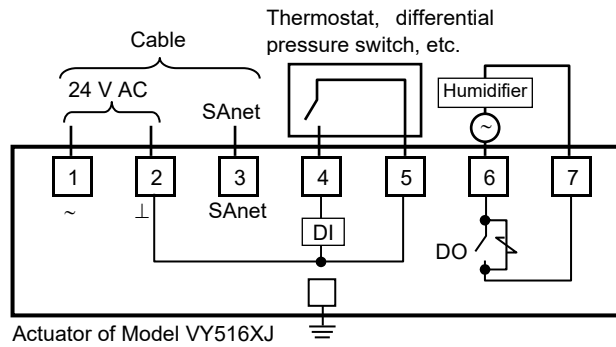

Figure 12. Basic connection example

- 4) Separate sub-DO line from SAnet and sub-DI lines. Do not lead the sub-DO line through the wiring port (knockout hole) for SAnet and sub-DI lines to protect sub-DO line from noise.

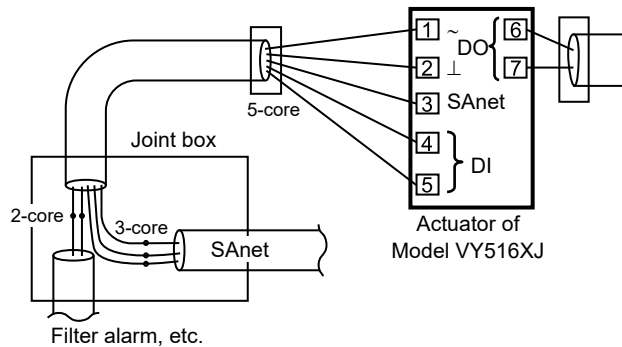

Figure 13. Separation of sub-DO line from other lines

If sub-I/O is used, SAnet line cannot be daisy-chained since the number of the wiring ports is limited. In such a case, use SAnet cable gland with three ports to daisy-chain the SAnet line, or branch the SAnet line ahead of connecting to the terminals.

Note:



For wiring of SAnet line, refer to the Installation Manual of Intelligent Component Series for SAnet Communication (AB-6713).





● **To keep IP54 protection (dust-proof and splash-proof),**

Use a water-proof connector for the ACTIVAL in a high-humidity environment or outdoor location. Through wiring port with the seal connector (Part No. 83104346-00X) attached to, 1 cable can be lead in. Through wiring port with the SAnet cable gland (with three ports) and the seal connectors attached to, 3 cables can be lead in.

- Be sure to completely close the terminal cover and the top cover.
- Waterproof the knockout hole.
 - For cable connection, use a water-proof connector. Following is the recommended parts Azbil Corporation supplies.
Seal connector: Part Nos. 83104346-003, 83104346-004, 83104346-005
 - To daisy-chain the SAnet line, use the SAnet cable gland with three ports and the seal connector Azbil Corporation supplies.
SAnet cable gland with three ports: Part No. DY7000A1000
Seal connector: Part Nos. 83104346-012, 83104346-013, 83104346-014
 - For conduit connection, use a water-proof plica tube or the like.

■ **Address Setting (Addressing)**

 WARNING	
	Before setup or engineering work, be sure to turn off power that is supplied from external devices to the output terminals. Failure to do so may cause electric shock.

 CAUTION	
	Do not put a load or weight on this product. Doing so may damage the product.
	Before setup or engineering work, be sure to turn off power that is supplied from external devices to the output terminals. Failure to do so may cause electric shock..
	Do not carelessly touch this product when it is used to control hot water. Doing so may result in burns, because the product reaches a high temperature.

To SAnet interface module, ACTIVAL Model VY516XJ and other Intelligent Component Series devices including ACTIVAL+ and damper actuators are connected via SAnet. Set address for the terminal devices (Intelligent Component Series devices) so that the SAnet interface module can recognize all the terminal devices connected. Follow the procedure below to set the address. For details regarding address setting (addressing), ask our sales/service personnel.

- 1) Unscrew the setscrews and remove the terminal cover. See Fig. 11 for removing the terminal cover.

- 2) Set address. (See Table 1.) Address can be set with rotary switch, with service pin switch, or based on SAnet ID. Rotary switch and service pin switch are provided on this product. To set the address with service pin switch or based on SAnet ID, Data Setter or PC-MMI is required. Set the address in either way according to your availability.

Setting with rotary switch:

Turn the rotary switch using a precision Phillips screwdriver and set.

Setting with service pin switch:

1. Set the rotary switch to '0'.
2. Start addressing operation* of Data Setter or PC-MMI. Then, press the service pin switch. Do not keep the switch pressed for longer than 5 seconds.
3. Address is set within 5 seconds after pressing the service pin switch.

* For the addressing operation of Data Setter or PC-MMI, ask our sales/service personnel.

Setting based on SAnet ID:

1. Set the rotary switch to '0'.
2. With Data Setter or PC-MMI, enter the SAnet ID (on the product code label) and address number to set. The product code label is attached on the side surface of the actuator, as shown in Fig. 15.

* For the addressing operation of Data Setter or PC-MMI, ask our sales/service personnel.

- 3) Attach the terminal cover after setting the address.

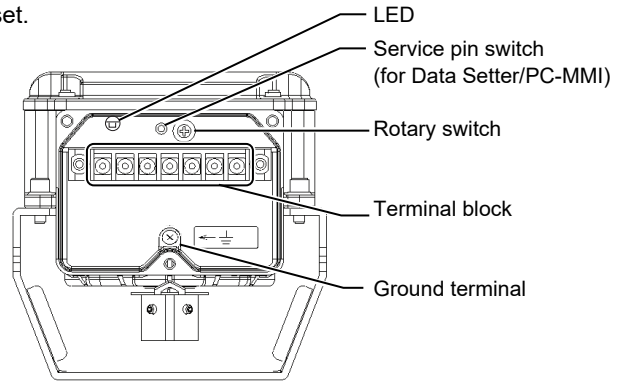

Figure 14. Terminal block, LED, setting switches (without terminal cover)

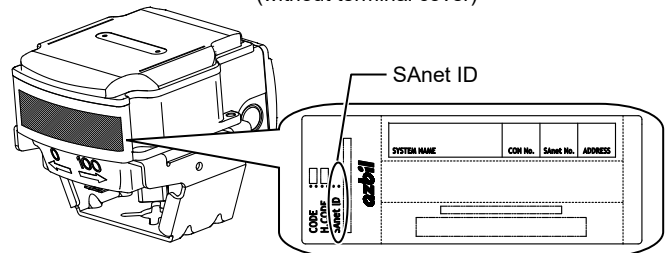

Figure 15. SAnet ID on the product code label

IMPORTANT:

- While the terminal cover is removed, do not touch the terminal block or allow anything to touch the terminal block.
- If the service pin switch is kept pressed for longer than 5 seconds, the mode will be switched and operation error (data point trouble) will be occurred. In such a case, press the service pin switch again and keep it pressed for longer than 10 seconds to go back to the normal mode.

Table 1. Basic address setting of this product and other Intelligent Component Series devices

Add.	Device	Sub-DO	Sub-DI
1	Outdoor air damper		
2	Exhaust air damper		
3	Return air damper		
4	Switch damper of total heat exchanger for outdoor air		
5	Switch damper of total heat exchanger for exhaust air		
6	Chilled/hot water valve / Chilled water valve		Filter alarm
7	Hot water valve (Chilled water valve)	Humidifying ON/OFF	
8	Humidifying valve		
D (13)	Reserved		
E (14)	Reserved		
F (15)	Reserved		

Notes:

- * For 'chilled/hot water valve + chilled water valve' application, set address 6 for chilled/hot water valve and 7 for chilled water valve.
- * Items in bold characters are the basic address to set for this product.
- * The above table is a basic setting example. Set address and use sub-I/O in response to system configuration, installation location, and wiring best suitable for your application.

■ System Indication Label

A part of the product code label can be a system indication label. Clip the part, and write down the name of the system, host controller number of the system, SAnet line number, and address. Then attach the part, as the system indication label, to a location where you can easily check.

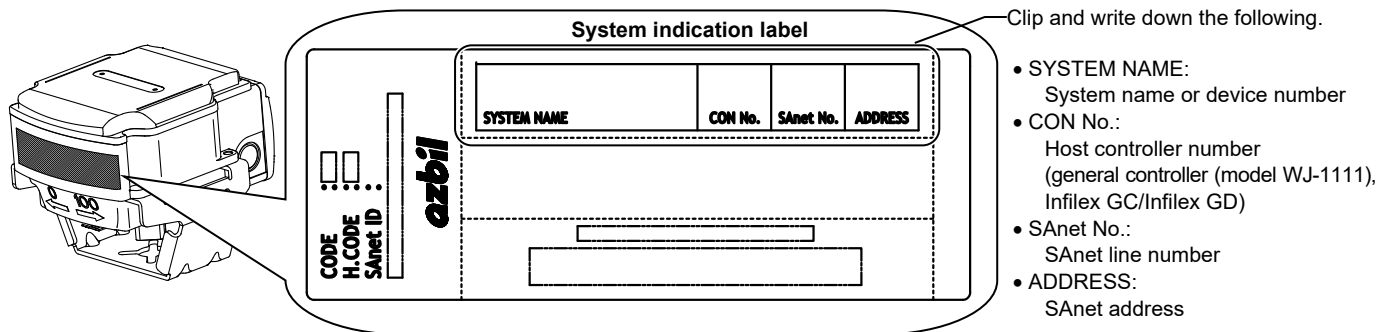

Figure 16. System indication label

IMPORTANT:

- Attach the system indication label to a clean location with no dust, oil, or moisture.
- Attach the system indication label by pressing the whole surface of the label to stick on the product surface.

⚠ WARNING

- ❗ After setup work, be sure to reattach the cover. Failure to do so may result in electric shock.
- ❗ Before setup or engineering work, be sure to turn off power that is supplied from external devices to the output terminals. Failure to do so may cause electric shock.

■ Manual Operation Mode

In the manual operation mode, even when this product has not been connected via SAnet yet, the operations shown in Table 2 can be performed and checked. Follow the procedure below for the operation check. For the locations of the service pin switch and the rotary switch, see Fig. 14.

- 1) Keep the service pin switch pressed for 10 seconds to enter the manual operation mode.
- 2) Turn the rotary switch to the desired position (See Table 2.), using a precision slotted screwdriver. Operation will start in 3 seconds after setting the rotary switch.

Table 2. Operations in the manual operation mode

Rotary switch scale	Operation
0	Restart (to go back to the normal operation mode)
2	Fully close (in 0 % position)
4	Open in 50 % position
6	Fully open (in 100 % position)
E	Automatic adjustment of the potentiometer

Notes:



- * Rotary switch scales 1, 3, 5, 7, 8, 9, A to D and F are not available in the manual operation mode.
- * Do not set the rotary switch to 'E'. (Operation of the rotary switch 'E' is required only when potentiometer itself is replaced.)



- 3) After the operation, press and hold the service pin switch for 10 seconds to go back to the normal operation mode.
- 4) If the address is set with the rotary switch, be sure to reset the rotary switch at the address after entering the normal operation mode.

⚠ WARNING

- ❗ After engineering work, be sure to reattach the cover. Failure to do so may result in electric shock.
- ❗ Before setup or engineering work, be sure to turn off power that is supplied from external devices to the output terminals. Failure to do so may cause electric shock.

■ Maintenance

 WARNING	
	Before doing maintenance, be sure to turn off the power to this product. Failure to do so may result in electric shock or device failure.
	After maintenance, be sure to reattach the cover. Failure to do so may result in electric shock.

 CAUTION	
	Do not put a load or weight on this product. Doing so may damage the product.
	Do not carelessly touch this product when it is used to control hot water. Doing so may result in burns, because the product reaches a high temperature.

- Inspect the ACTIVAL according to Table 3.
- Manually open/close the ACTIVAL at least once a month if it is left in inactive state for a long period.
- Visually inspect the fluid leakage of the valve and the actuator operations every six months. If any of the problems described in Table 4 are found, take corresponding actions shown in the table.
If your problem is not solved by the corresponding action, please contact Azbil Corporation near you.

Table 3. Inspection items and details

Inspection item	Inspection interval	Inspection detail
Visual inspection	Semiannual	<ul style="list-style-type: none"> • Fluid leakage from the gland and the flange face • Loosened bolts • Valve and actuator damages
Operating status	Semiannual	<ul style="list-style-type: none"> • Unstable open/close operation • Abnormal noise and vibration
Routine inspection	Any time	<ul style="list-style-type: none"> • Fluid leakage to the outside • Abnormal noise and vibration • Unstable open/close operation • Valve hunting

Table 4. Troubleshooting

Problem	Part to check	Action
Fluid leaks from the flange face.	Loosened flange bolts Gasket on the flange face Misaligned piping	Tighten the flange bolts. Replace the gasket. Redo piping.
Fluid leaks from the gland part.	—	Consult with our sales personnel.
Fluid leaks from the bonnet.	Loosened bolts	Tighten the bolts.
Valve does not operate smoothly / valve stops halfway / valve does not operate at all.	Conditions of the power applied and of the input signal applied Loosened terminals Wiring condition / disconnected wires	Check the power supply and the controller connected to. Tighten the terminals. Check the wiring.
Fluid leaks to the outside of the valve when the ACTIVAL is in fully closed position.	Actuator pointer not pointing to fully closed position	Fully close the ACTIVAL.
The valve vibrates or produces an abnormal noise.	Primary pressure condition Differential pressure condition	Adjust the mounting position and change the installation location.
Valve hunting occurs.	Secondary pressure condition Differential pressure condition Control stability	Adjust the mounting position and change the installation location. Correct the control parameter setting of controller.
SAnet communication error occurs.	—	Consult with our sales/service personnel.

■ Disposal

Dispose of this product as industrial waste in accordance with your local regulations.
Do not reuse all or any part of the product.

This blank page was added for page layout purposes.

This blank page was added for page layout purposes.



This product complies with the following Electromagnetic Compatibility (EMC).
EMC: EN61000-6-2, EN55011 Class A

ACTIVAL and savic-net are trademarks of Azbil Corporation in Japan or in other countries.
BACnet is a registered trademark of American Society of Heating, Refrigerating and Air-Conditioning Engineers (ASHRAE).
KPEV is a registered trademark of Furukawa Electric Co., Ltd.

azbil

Specifications are subject to change without notice.

Azbil Corporation

Building Systems Company

1-12-2 Kawana, Fujisawa, Kanagawa
251-8522 JAPAN

<https://www.azbil.com/>