

# ACTIVAL™

## Motorized Two-Way Valve with Flanged-End Connection (Spring Return Type Actuator) <4-20 mA DC Input with 4-20 mA DC Feedback Output> (JIS 10K-FC200, -SCS13A)

### ■ Overview

ACTIVAL model VY519XH/VY519XK is a series of motorized two-way valves with flanged-end connection. The valve and actuator are integrated in a single unit.

Valve size ranges from DN15 (1/2") to DN80 (3"), and valve body rating corresponds to JIS 10K.

The actuator has a reversible synchronous motor, which operates at a low voltage of 24 V AC. Since the actuator fully closes the valve in case of power failure, it is suitable for failsafe application.

4-20 mA DC input control signal provides proportional control in combination with a PLC (e.g., Model R35/R36).

\* JIS: Japanese Industrial Standards

PLC: Programmable Logic Controller



### ■ Features

- Compact and lightweight  
Rotary motor actualizes small body and light weight.
- Valve and actuator integrated in a single unit  
Pre-assembled body requires no adjustment.
- Dust- and splash-proof structure (IEC IP54)  
Installable in an AHU.  
Note: Waterproof connectors are required to ensure IP54.
- Valve for water/steam control applicable to high differential pressure, large Cv value, high rangeability, and low leakage.
- Durable actuator with low power consumption.
- Equal percentage flow characteristics.
- 4-20 mA DC output available for position feedback.
- Open/close changeover for input signal failure:  
Actuator fully opens/closes valve in case that the control signal is not input to the actuator. (Default: Fully open)
- Direction changeover of control action:  
Open/close action by 4-20 mA DC input signal is reversely controllable.  
Normal action 4 mA: 0 % to 20 mA: 100 %  
Reverse action 20 mA: 0 % to 4 mA: 100 %.  
(Default: Normal action)

- Adjustable dead band\*:  
Dead band width can be narrowed to more precisely operate valve actuator.  
\* Actuator is not operated by input signal changed less than a certain amount. This amount of change is called dead band.
- Spring return actuator:  
Actuator automatically closes the valve in 0 % position in case that the power is down.

**IMPORTANT**

- The service life of ACTIVAL operated with small dead band can be shortened since the ACTIVAL operates more frequently with small dead band than with normal dead band.
- Use shielded cable for the ACTIVAL with small dead band. Noise may affect the signal transmission causing operation error, otherwise.
- To control ACTIVAL with a third-party controller, please consult with Azbil Corporation's sales personnel.

## Safety Precautions

Please read instructions carefully and use the product as specified in this manual. Be sure to keep this manual near by for ready reference.

### Restrictions on Use

This product was developed, designed, and manufactured for general air conditioning use.

Do not use the product in a situation where human life may be at risk or for nuclear applications in radiation controlled areas. If you wish to use the product in a radiation controlled area, please contact Azbil Corporation.

Particularly when the product is used in the following applications where safety is required, implementation of fail-safe design, redundant design, regular maintenance, etc., should be considered in order to use the product safely and reliably.

- Safety devices for protecting the human body
- Start/stop control devices for transportation machines
- Aeronautical/aerospace machines

For system design, application design, instructions for use, or product applications, please contact Azbil Corporation.

Azbil Corporation bears no responsibility for any result, or lack of result, deriving from the customer's use of the product.

### Recommended Design Life

It is recommended that this product be used within the recommended design life.

The recommended design life is the period during which you can use the product safely and reliably based on the design specifications.

If the product is used beyond this period, its failure ratio may increase due to time-related deterioration of parts, etc.



The recommended design life during which the product can operate reliably with the lowest failure ratio and least deterioration over time is estimated scientifically based on acceleration tests, endurance tests, etc., taking into consideration the operating environment, conditions, and frequency of use as basic parameters.

The recommended design life of this product is 10 years.





The recommended design life assumes that maintenance, such as replacement of the limited life parts, is carried out properly.



Refer to the section on maintenance in this manual.



## Warnings and Cautions







 <b>WARNING</b>	Alerts users that improper handling may cause death or serious injury.
 <b>CAUTION</b>	Alerts users that improper handling may cause minor injury or material loss.







## Symbols

	Notifies users that specific actions are prohibited to prevent possible danger. The symbol inside  graphically indicates the prohibited action. (For example, the sign on the left notifies that disassembly is prohibited.)
	Instructs users to carry out a specific obligatory action to prevent possible danger. The symbol inside  graphically indicates the actual action to be carried out. (For example, the sign on the left indicates general instructions.)

<b>⚠ WARNING</b>	
	When handling or transporting any heavy product (more than 18 kg), carefully move the product with a hand truck or the like, or with 2 or more people. Careless lifting or accidental dropping of the product may result in injury or product damage.
	Before removing the actuator, fully close the valve. If you try to remove the actuator without fully closing the valve, the actuator may suddenly rotate and cause an injury.
	Do not disassemble the spring unit. The spring may fly out of the unit and cause an injury.

<b>⚠ CAUTION</b>	
	Provide a circuit protector (e.g., a fuse or circuit breaker) for the power source. Failure to do so may cause a short circuit leading to fire or device failure
	Do not freeze this product. Doing so may damage the valve body and cause leakage.
	When piping this product, be sure there is no foreign matter in the pipes. If foreign matter remains in the pipes, the product may break down.

⚠ CAUTION	
	Install, wire, and use this product under the conditions specified by this manual. Failure to do so may cause fire or device failure.
	Use full face gaskets for flat face flanges. Failure to do so may damage the flanges or cause leakage outside of the valve.
	When installing this product, hold it in the proper position and securely fasten it to the pipes. Excessive tightening or improper installation position may damage the valve.
	After installation, make sure no fluid leaks from the valve-pipe connections. Improper piping may cause fluid leakage outside of the valve.
	Do not put a load or weight on this product. Doing so may damage the product.
	Installation and wiring of the actuator must be performed by personnel qualified to do instrumentation and electrical work. Mistakes in installation or wiring may cause fire or electric shock

⚠ CAUTION	
	Before wiring, setting, maintenance, or replacement, be sure to turn off the power to this product. Failure to do so may result in electric shock or device failure.
	All wiring must comply with applicable codes and ordinances. Otherwise there is a danger of fire.
	Use crimp terminals with insulation for connections to the product terminals. Failure to do so may cause short circuit leading to fire or device failure.
	Tighten the terminal screws with the specified torque. Insufficient tightening of the terminal screws may cause fire or overheating.
	After wiring, setting, engineering, maintenance, or replacement work, be sure to reattach the cover. Failure to do so may result in electric shock.
	Do not carelessly touch this product when it is used to control hot water. Doing so may result in burns, because the product reaches a high temperature.

■ Model Numbers

Model VY519XK00XX/VY519XH00XX is the model for the valve and actuator integrated into a single unit. The model number label is attached to the yoke.

Base model number	Actuator/valve		Actuator		Valve	Description		
	Control signal	Rating/material	Type	—	Nominal size/Cv			
VY51	9					Motorized two-way valve with flanged-end connection		
							4 mA DC to 20 mA DC input with 4 mA DC to 20 mA DC feedback output	
						5	JIS 10K / JIS FC200 [for 0 °C to 175 °C steam]	
		6	JIS 10K / JIS SCS13A [for 0 °C to 175 °C steam]					
							K	IEC IP54 protected and standard torque type spring return actuator with terminal block (Mountable valve sizes: DN15 to DN80)
	H						IEC IP54 protected and standard torque type spring return actuator with terminal block for high differential pressure application (Mountable valve sizes: DN15 to DN80)	
					00		—	
						11	DN15 (1/2") / 1.0 in Cv value	
						12	DN15 (1/2") / 2.5 in Cv value	
						13	DN15 (1/2") / 6.0 in Cv value	
						14	DN15 (1/2") / 1.6 in Cv value	
						15	DN15 (1/2") / 4.0 in Cv value	
						21	DN25 (1") / 10 in Cv value	
					22	DN25 (1") / 16 in Cv value		
					41	DN40 (1 1/2") / 25 in Cv value		
					42	DN40 (1 1/2") / 40 in Cv value		
					51	DN50 (2") / 65 in Cv value		
					61	DN65 (2 1/2") / 95 in Cv value		
					81	DN80 (3") / 125 in Cv value		

● Options

Item	Model number		Specification	
Seal connector <sup>*1</sup>	83104346-	003	Applicable wire size	φ7 mm to φ9 mm
Auxiliary switch <sup>*2</sup>	83174063-	101	Number of auxiliary switches	2
			Max. applied voltage/current	30 V DC / 100 mA <sup>*3</sup> (Inductive load includes inrush current.)
			Actuating position	SW A: Adjustable between 0 % (fully closed) to 100 % (fully open)
				SW B: Adjustable between 0 % (fully closed) to 100 % (fully open)
Auxiliary potentiometer <sup>*2</sup>	83165275-	001	Number of auxiliary potentiometer	1
			Overall resistance	Nominal 1 kΩ
			Operating position	0 % (fully closed) to 100 % (fully open)
			Max. applied voltage	5 V DC Note: The potentiometer cannot be connected to model M904E.
Outdoor cover	DY3001A1017		Material	Stainless steel plate t1.0
			Weight	Approx. 550 g

\* 1 Required to maintain IP54.

\* 2 Either of an auxiliary switch or an auxiliary potentiometer can be added, but not both.  
For details, refer to the user's manual attached to the product.

\* 3 If the applied current exceeds 100 mA, please contact Azbil Corporation.

■ Specifications

● Valve and actuator

Item	Specification		
Operating conditions	Rated operating conditions	Ambient temperature*1	-20 to 50°C (Fluid temperature: 0 to 150°C) -20 to 40°C (Fluid temperature: 150 ~ 175°C)
		Ambient humidity	5 to 95 %RH
		Vibration	4.9 m/s <sup>2</sup> (10 to 150 Hz)
	Transport storage conditions*2 (in packed state)	Ambient temperature*1	-20 to 70 °C
		Ambient humidity	5 to 95 %RH
		Vibration	19.6 m/s <sup>2</sup> (10 to 150 Hz)
Notes		<p>A line graph with 'Ambient temperature (°C)' on the y-axis and 'Fluid temperature (°C)' on the x-axis. The y-axis has a break between -20 and 40. The x-axis has a break between 0 and 100. The graph shows a horizontal line at 50°C from 0 to 150°C, then a downward sloping line to 40°C at 175°C, and finally a vertical line at 40°C from 175°C to the end of the axis.</p>	
*1 Do not allow the fluid to freeze *2 The actuator shall be packed during transport.			
Installation location	Indoor use Note: Salt air, corrosive gas, flammable gas, and organic solvent must be avoided.		
	Outdoor use Note: Salt air, corrosive gas, flammable gas, and organic solvent must be avoided. And, use the outdoor cover (to be ordered separately) etc. to avoid direct sunlight.		
Mounting position	Refer to ■ "Installation," ● "Mounting position."		
Manual operation	Not available.		
Insulation resistance	Between terminal and case	5 MΩ or higher at 500 V DC	
Withstand voltage	Between terminal and case	500 V AC/min with 1 mA or less leakage current	
Weight	Model VY51__K00	11	6.6 kg
		12	
		13	
		14	
		15	
	21	22	8.6 kg
	42		
	51	13.5 kg	
	61	18.0 kg	
	81	20.5 kg	
	Model VY51__H00	61	18.5 kg
		81	21.0 kg

## ● Valve

Item	Specification				
Type	Two-way valve with flanged-end connection				
Body pressure rating	JIS 10K (Max. pressure: 1.0 MPa)				
Size, Cv, Close-off ratings  Note: Close-off ratings of the actuator in combination are shown on the right. Actual close-off rating required for the valve controlling 175 °C steam is 0.8 MPa	Model number		Nominal size	Cv	Close-off ratings
	VY519_K00	11	DN15 (1/2")	1.0	1.0 MPa
		12	DN15 (1/2")	2.5	
		13	DN15 (1/2")	6.0	
		14	DN15 (1/2")	1.6	
		15	DN15 (1/2")	4.0	
		21	DN25 (1")	10	
		22	DN25 (1")	16	
		41	DN40 (1 1/2")	25	
		42	DN40 (1 1/2")	40	
		51	DN50 (2")	65	
	61	DN65 (2 1/2")	95	0.3 Mpa	
	81	DN80 (3")	125	0.1 MPa	
	VY519_H00	61	DN65 (2 1/2")	95	1.0 MPa
81		DN80 (3")	125	0.7 MPa	
End connection	Flanged-end connection (JIS 10K) Full face flange (FF) body: cast iron (models VY5195K and VY5195H [JIS FC200]) Raised face flange (RF) body: stainless steel (models VY5196K and VY5196H [JIS SCS13A])				
Applicable fluid	Steam				
Allowable fluid temperature	0 to 175 °C				
Flow characteristic	Equal percentage				
Rangeability	100 : 1				
Leakage from valve seat	0.01 % or less of rated Cv value (0.0006 Cv or less for DN15 model)				
Materials	Body		Gray cast iron (JIS FC200) Stainless steel (JIS SCS13A)		
	Plug and stem		Stainless steel (equivalent to JIS SCS)		
	Seat ring		Heat-resistant PTFE		
	Gland packing		Inorganic fiber		
	Gasket		Non-asbestos joint sheet		
Paint color	Gray (equivalent to M5B 4/1): Body (JIS FC200) Unpainted: Body (JIS SCS13A)				
Actuator mounting	Integrated with the valve				

● Actuator

Item	Specification	
Power supply	24 V AC $\pm$ 15 %, 50 Hz/60 Hz	
Power consumption	16 VA	
Type	Spring return actuator for standard and high differential pressure application	
Service life of spring return action	30,000 operations	
Valve travel time	63 $\pm$ 5s (50 Hz) / 53 $\pm$ 5s (60Hz) Return time: 3 to 40 seconds (Fully open $\rightarrow$ fully close operation)	
Control signal	4 mA DC to 20 mA DC input	Input impedance: 100 $\Omega$
Feedback signal	Range	4 mA DC (0 % position) to 20 mA DC (100 % position)
	Max. load resistance	500 $\Omega$
Valve position indication	Indicator: 0 (fully closed) to 100 (fully open) Can be seen from the forward, backward, or lower position.	
Wiring	Screwed on the terminal block (M3.5), tightening torque 0.8–1.0N·m Note: Open an appropriate knockout hole (dia. 22) located on both sides of the actuator at the worksite.	
Enclosure protection	IEC IP54 (dust-proof and splash-proof)	
Factory preset position	100 % (fully open)	
Materials	Case	Aluminum alloy casting
	Top cover, terminal cover	Polycarbonate resin (color: gray [equivalent to DIC-651])
	Yoke	Steel plate
	Case of the spring unit	Aluminum alloy casting
	Cover of the spring unit	Aluminum alloy casting
	Spring	Stainless steel
Surface finishing	Case	None
	Yoke	Electro-galvanizing (Bright chromate finish)



■ Dimensions

● Model VY5195K/VY5195H (JIS FC200 valve)

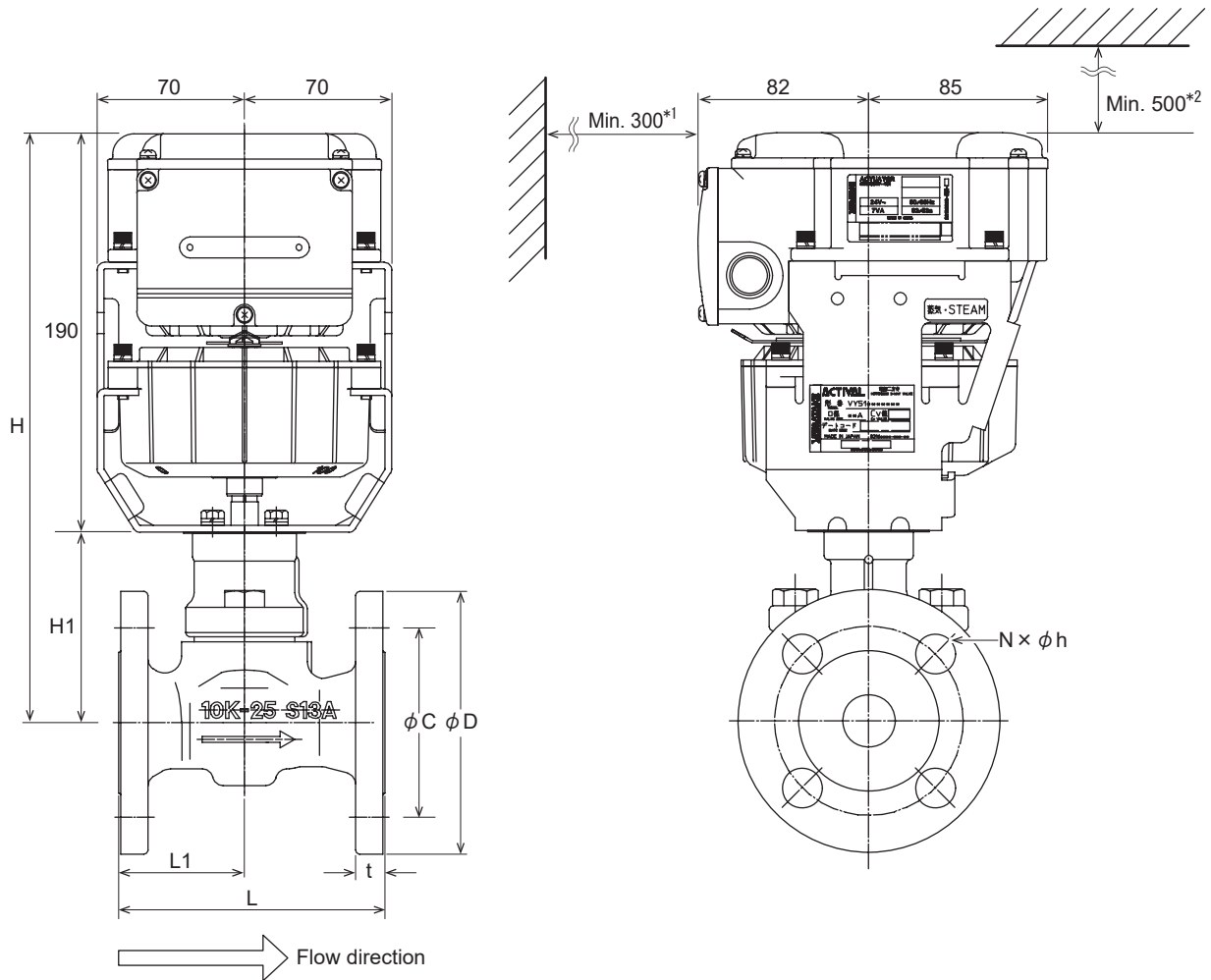

\*1 Clearance for maintenance.

\*2 If you do not need to open the top cover and set the selector switches after installing the valve, it is OK to leave only 100 mm of clearance.

Figure 1 Dimensions (mm)

Table1 Dimensions (mm)

Model VY5195K00\_ \_

Valve size (DN)	H	H <sub>1</sub>	L	L <sub>1</sub>	t	φC	φD	φh	N	Weight (kg)
15	265	75	108	50	16	70	95	15	4	6.6
25	280	90	127	60	18	90	125	19	4	8.6
40	293	103	165	82.5	20	105	140	19	4	12.0
50	297	107	178	89	20	120	155	19	4	13.5
65	314	124	190	90	22	140	175	19	4	18.0
80	315	125	203	100	22	150	185	19	8	20.5

Table2 Dimensions (mm)

Model VY5195H00\_ \_

Valve size (DN)	H	H <sub>1</sub>	L	L <sub>1</sub>	t	φC	φD	φh	N	Weight (kg)
65	314	124	190	90	22	140	175	19	4	18.5
80	315	125	203	100	22	150	185	19	8	21.0

● Model VY5196K/VY5196H (JIS SCS13A valve)

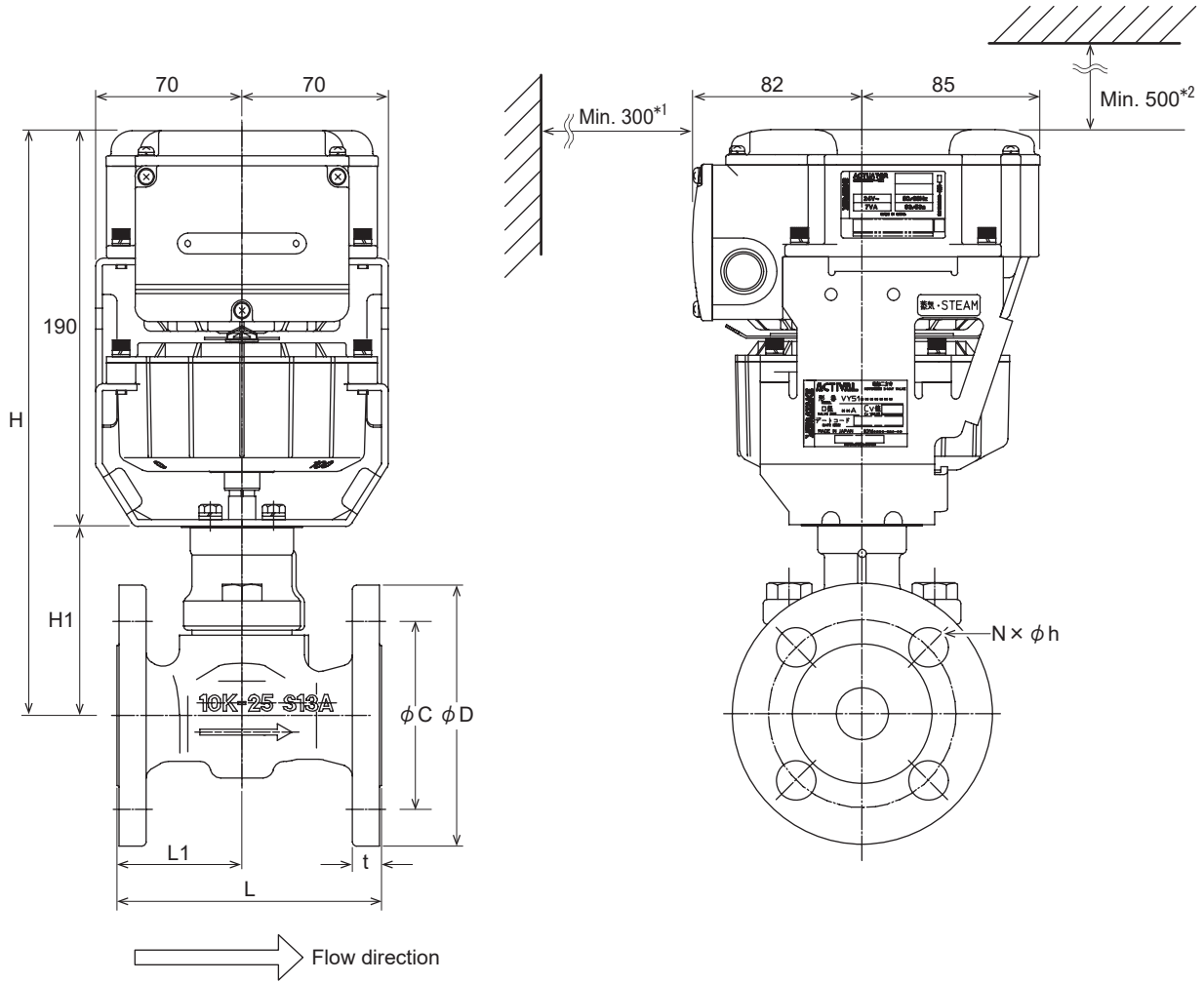

\*1 Clearance for maintenance.

\*2 Leave a clearance of 100 mm if you do not open the top cover (to set the selector switches) after the ACTIVAL is installed

Figure2 Dimensions (mm)

Table3 Dimensions (mm)

Model VY5196K

Valve size (DN)	H	H <sub>1</sub>	L	L <sub>1</sub>	t	φg	φC	φD	φh	N	Weight (kg)
15	265	75	108	50	12	51	70	95	15	4	6.6
25	280	90	127	60	14	67	90	125	19	4	8.6
40	293	103	165	82.5	16	81	105	140	19	4	12.0
50	297	107	178	89	16	96	120	155	19	4	13.5
65	314	124	190	90	18	116	140	175	19	4	18.0
80	315	125	203	100	18	126	150	185	19	8	20.5

Table4 Dimensions (mm)

Model VY5196H

Valve size (DN)	H	H <sub>1</sub>	L	L <sub>1</sub>	t	φC	φD	φh	N	Weight(kg)
65	314	124	190	90	18	140	175	19	4	18.5
80	315	125	203	100	18	150	185	19	8	21.0

■ Parts Indication

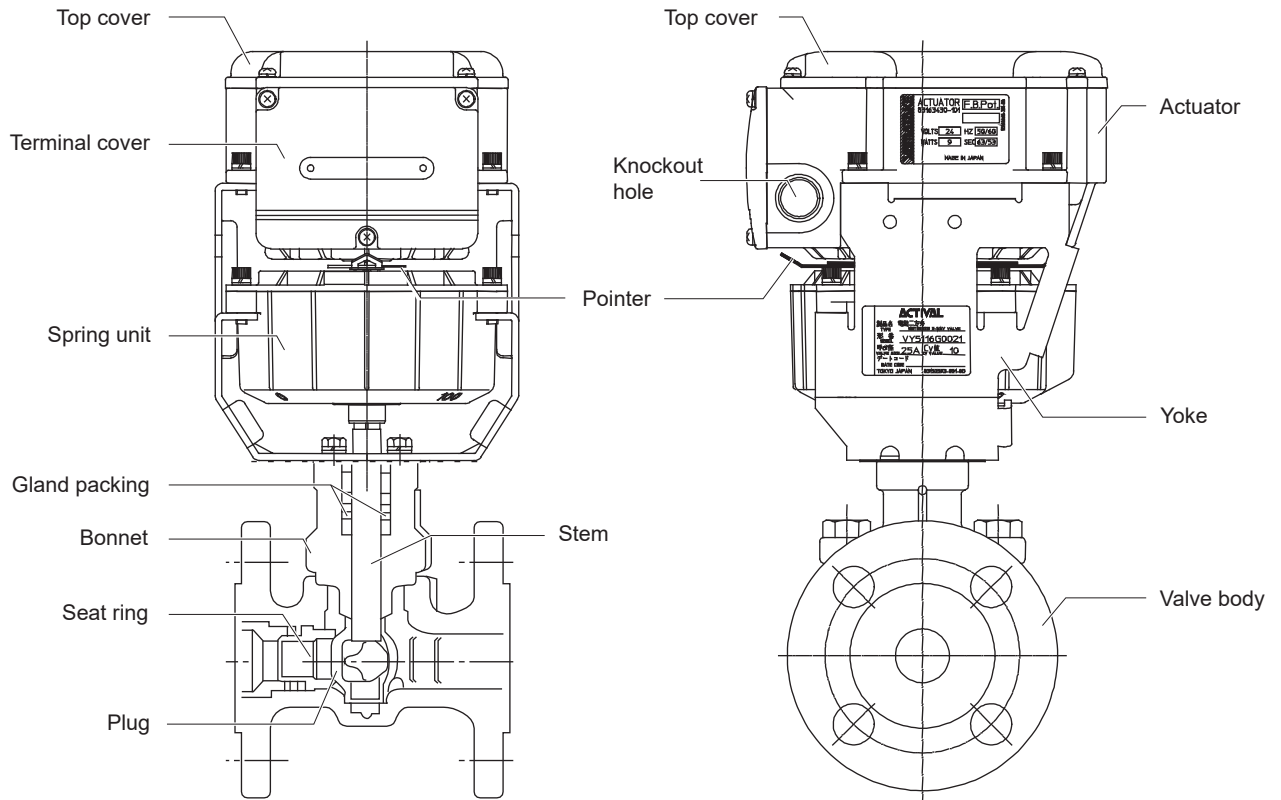





Figure3 Parts indication

**Setting**

On the PCB (printed circuit board) of the actuator, the selector switches are provided.

<b>⚠ CAUTION</b>	
	Before beginning setup work, be sure to turn off the power to this product. Failure to do so may result in electric shock or device failure.
	After setup work, be sure to reattach the cover. Failure to do so may result in electric shock.
	Do not touch any parts unless instructed to do so in this manual. Failure to observe these precautions may result in burns, because actuator parts reach a high temperature.

<p><b>IMPORTANT</b></p> <ul style="list-style-type: none"> <li>• Set the selector switches using a pen nib or fingers. Do not use a tool such as a screwdriver. Such a tool can damage the selector switches or the PCB.</li> <li>• The service life of ACTIVAL operated with small dead band can be shortened since the ACTIVAL operates more frequently with small dead band than with normal dead band.</li> <li>• To operate the ACTIVAL with small dead band, provide shielded cable for input/output signal lines and power line. Unshielded cable can cause error due to noise.</li> </ul>
---

**● Identification of the selector switches**

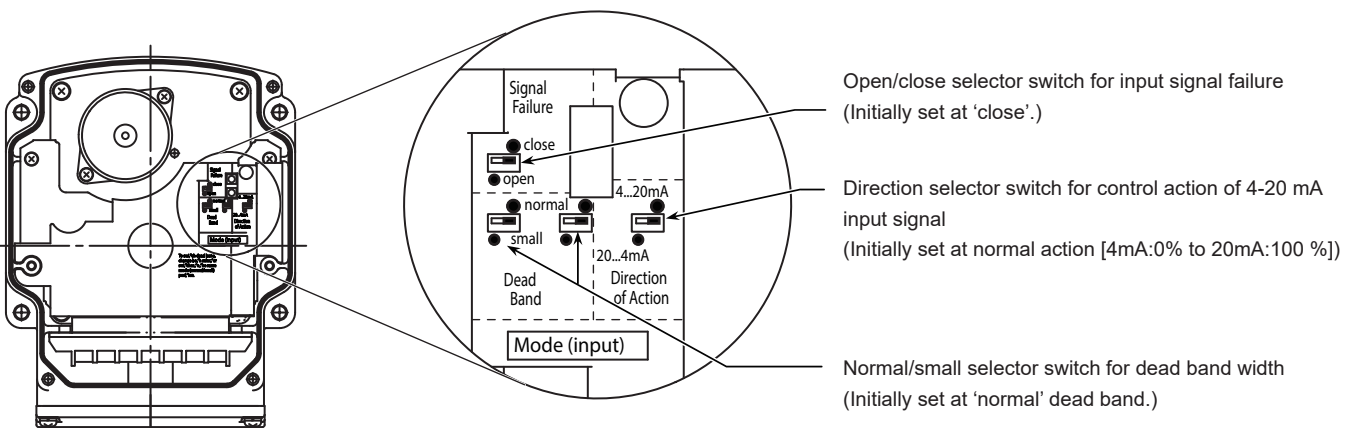

Figure 4 Selector switches

Open/close selector switch for input signal failure:

If no control signal is input, the actuator automatically closes (0 %) or opens (100 %) the valve by setting the selector switch at 'open' (100 %) or 'close' (0 %).

Direction selector switch for control action of 4-20 mA input signal:

Direction of control action by 4-20 mA DC input signal can be reversely switched.



Normal action: 4 mA for 0 % to 20 mA for 100 %



Reverse action: 20 mA for 0 % to 4 mA for 100 %

Normal/small selector switch for dead band width:

To more precisely operate the valve, smaller dead band (than the normal) of the control signal input can be set. Two selector switches are provided for the normal/small dead band width. Always set the both switches at the same mode ('normal' or 'small').

■ Installation

⚠WARNING	
	When handling or transporting any heavy product (more than 18 kg), carefully move the product with a hand truck or the like, or with 2 or more people. Careless lifting or accidental dropping of the product may result in injury or product damage.
	Before removing the actuator, fully close the valve. If you try to remove the actuator without fully closing the valve, the actuator may suddenly rotate and cause an injury.

⚠CAUTION	
	Install, wire, and use this product under the conditions specified by this manual. Failure to do so may cause fire or device failure.
	Do not put a load or weight on this product. Doing so may damage the product.
	Installation and wiring of the actuator must be performed by personnel qualified to do instrumentation and electrical work. Mistakes in installation or wiring may cause fire or electric shock

● Precautions for installation

Observe the following cautions in order to avoid failure of this product.

- Do not strike or jar this product.
- Do not submerge the actuator.
- Be sure there is no foreign matter in the pipes. Observe the following instructions to remove foreign matter.
  - Install a strainer on the upstream side of the product.
    - For steam: 80 or more mesh
  - If the strainer cannot be installed just before the inlet of each valve, install it on the pipe diverting sections for each piping group.
- Do not install this product near a steam coil, hot water coil, etc. High-temperature radiant heat may cause failure of the actuator.
- Avoid connecting the product to piping where water hammer may occur or slag, etc. easily collects.

**IMPORTANT**

- Position the pipes so that drainage does not accumulate next to the valve. If there is remaining drainage, the valve or pipes may be damaged by steam hammer or corrosion.
  - Install a trap so that drainage does not accumulate or use a valve made of stainless steel with high erosion and corrosion resistance (JIS SCS13A).
- When the product is used for steam humidifying, install a valve interlocking with air-conditioning unit on the inflow side in case the product gets damaged.

In addition, observe the following cautions.

- Install a bypass pipe and gate valves on the inflow, outflow, and bypass sides.
- Install the product in a position allowing easy access for maintenance and inspection.
  - Refer to ■Dimensions"
- When installing the product in the ceiling, provide a trapdoor within 50 cm around the valve. And, place a drain pan under the valve.
- Leave enough space (as shown in figures 1 and 2) to set the selector switches after installing the valve.

● Mounting position

Install the product so that fluid flows in the direction pointed by the arrow on the body. It can be mounted in any position ranging from upright to sideways (90° tilted).

Note: If the product is installed outdoors, place it in upright position.

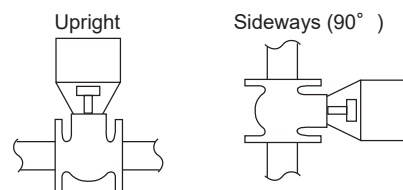

Figure5 Correct mounting

Actuator is below the valve

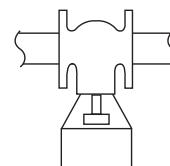









Figure6 Incorrect mounting

● Piping

⚠ WARNING	
	<p>When handling or transporting any heavy product (more than 18 kg), carefully move the product with a hand truck or the like, or with 2 or more people. Careless lifting or accidental dropping of the product may result in injury or product damage.</p>

⚠ CAUTION	
	<p>Do not freeze this product. Doing so may damage the valve body and cause leakage.</p>
	<p>When piping this product, be sure there is no foreign matter in the pipes. If foreign matter remains in the pipes, the product may break down.</p>
	<p>Install and use this product according to the specifications stated in this manual. Failure to do so may cause device failure.</p>
	<p>Use full face gaskets for flat face flanges. Failure to do so may damage the flanges or cause leakage outside of the valve.</p>
	<p>When installing this product, hold it in the proper position and securely fasten it to the pipes. Excessive tightening or improper installation position may damage the valve.</p>
	<p>After installation, make sure no fluid leaks from the valve-pipe connections. Improper piping may cause fluid leakage outside of the valve.</p>
	<p>Do not put a load or weight on this product. Doing so may damage the product.</p>

(1) Check that the model number of the product is what you ordered. The model number is shown on the label attached to the yoke.

(2) Install the valve so that fluid flows in the direction pointed by the arrow on the valve body.

Refer to ●Mounting position”

- When piping, do not apply too much sealing material, such as solidifying liquid and tape, to the pipe connection sections.
- Do not allow chippings, sealing material, etc. to get into the pipes.

The foreign matter, such as chippings, seal material for screwing the pipes, may be caught in, resulting damages on the valve seat and the valve may not be fully closed.

(3) Fully open the valve and flush the pipes at the maximum flow rate. When fluid flows for the first time, it is to clean out the foreign matter and refuse in the pipes. The valve is set to fully open when it is shipped from the factory.

● Heat insulation

- Apply heat insulation in the area illustrated by [ ] in figure 7.
- If the heat insulation material is placed above the yoke, the indicator may be hidden from sight or be deformed by being entangled with the insulation material.

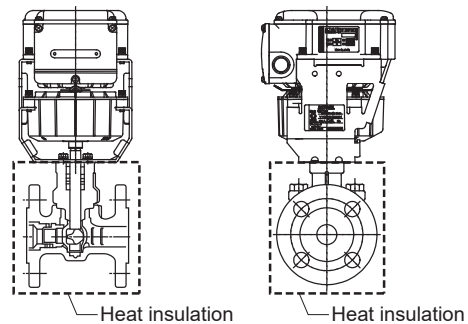

Figure 7 Heat insulation

● Factory preset position

Actuator shaft: fully open

Pointer: completely turned clockwise

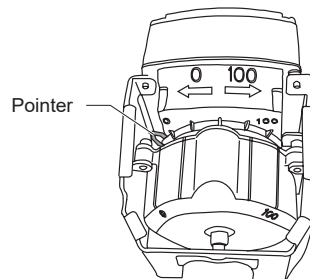









Figure 8 Pointer position for shipment

● Auxiliary switch/potentiometer (optional)

**IMPORTANT** •The auxiliary switch/potentiometer is installed on site. Refer to the instructions supplied with the auxiliary switch/potentiometer for installation.

- Do not open the top cover except when adjusting the auxiliary switch/potentiometer. Close the top cover instantly after adjusting the auxiliary switch/potentiometer.
- Do not put any load on the top cover.

■ Wiring

⚠ CAUTION	
	Provide a circuit protector (e.g., a fuse or circuit breaker) for the power source. Failure to do so may cause a short circuit leading to fire or device failure.
	Install, wire, and use this product under the conditions specified by this manual. Failure to do so may cause fire or device failure
	Installation and wiring of the actuator must be performed by personnel qualified to do instrumentation and electrical work. Mistakes in installation or wiring may cause fire or electric shock.
	Before wiring, be sure to turn off the power to this product. Failure to do so may result in electric shock or device failure.
	All wiring must comply with applicable codes and ordinances. Otherwise there is a danger of fire.
	Use crimp terminals with insulation for connections to the product terminals. Failure to do so may cause short circuit leading to fire or device failure.
	Tighten the terminal screws with the specified torque. Insufficient tightening of the terminal screws may cause fire or overheating.

**IMPORTANT**

- This product is designed for 24 V AC power supply voltage. Do not apply any other power voltage (e.g., 100 V AC, 200 V AC) to the ACTIVAL.
- Check the polarity of the power supply and of the 4-20 mA DC feedback signal against the wiring diagram to make sure that the product is correctly wired. Incorrect wiring may result in burnout of the printed circuit board, etc.
- Do not connect 24 V AC power to the terminals 4 to 7.

● To keep IP54 protection (dust-proof and splash-proof)

- Use a water-proof connector for the ACTIVAL in a high-humidity environment or outdoor location.
- Be sure to completely close the terminal cover and the top cover.
  - Apply a waterproofing treatment for the knockout hole.
  - For cable connection, use the waterproof connector (to be ordered separately).
  - For conduit connection, use the waterproof plica tubes, etc.

● Wiring procedure

- (1) Select a knockout hole according to the wire outlet direction, and open a knockout hole.  
Two knockout holes are provided on the bilateral sides of the actuator. The knockout holes can be easily opened by lightly knocking the hole using a screwdriver.

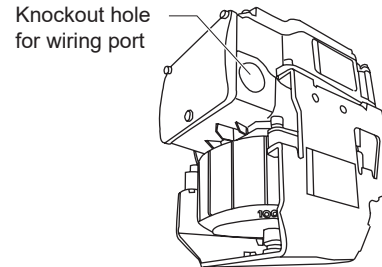

**IMPORTANT**

- Do not leave any refuse including metal chips after cutting a knockout hole and after connecting the wires inside the actuator.

- (2) Unscrew the 3 setscrews (M4 × 10) of the terminal cover and remove the terminal cover.

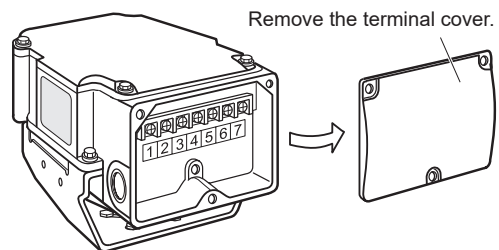
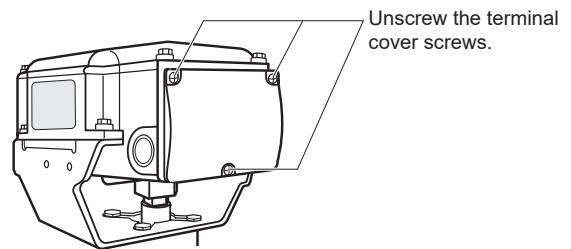

- (3) Connect the wires to the terminals (screws are M3.5). Do not apply 24 V AC to terminals 4 to 7.

Note: Correctly connect the wires referring to figures 9, 10, and 11.

- (4) Attach the terminal cover and fasten it with the setscrews.

**⚠ CAUTION**

 After wiring, be sure to reattach the cover. Failure to do so may result in electric shock.

**Terminals connection**

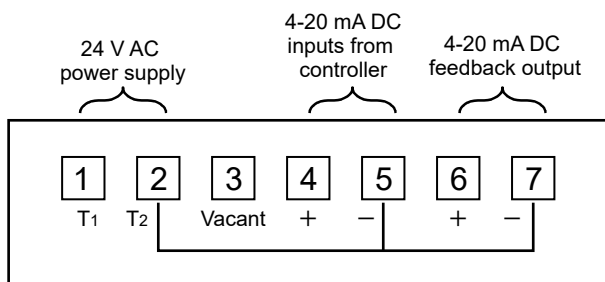

Note: Terminals 2, 5, and 7 are connected inside the actuator  
 Figure9 Terminals connection of Model VY519XK/VY510XH

**Connection Examples (Connection to Azbil Corporation’s R series controller)**

Connection to Model R35TC0/R36TC0

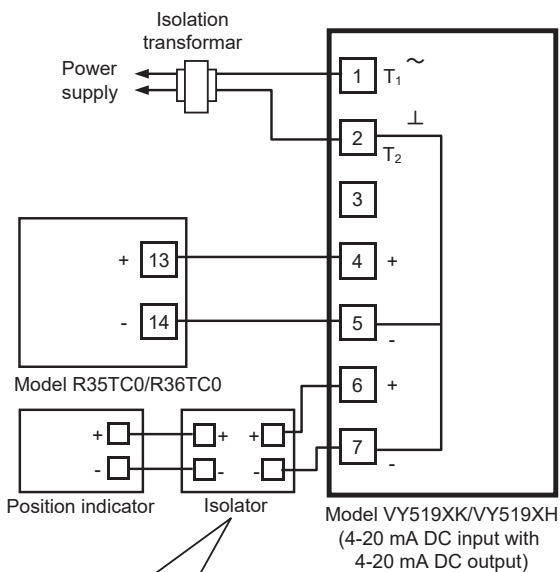

Isolation example:  
 If the position indicator is not isolated inside, provide an isolator. If isolated, an isolator is not required.

Figure 10 Connection example:  
 Single model VY519\_K/VY519\_H with model R35TC0/R36RC

Connection to Model R35TC0/R36TC0 (Parallel operation)

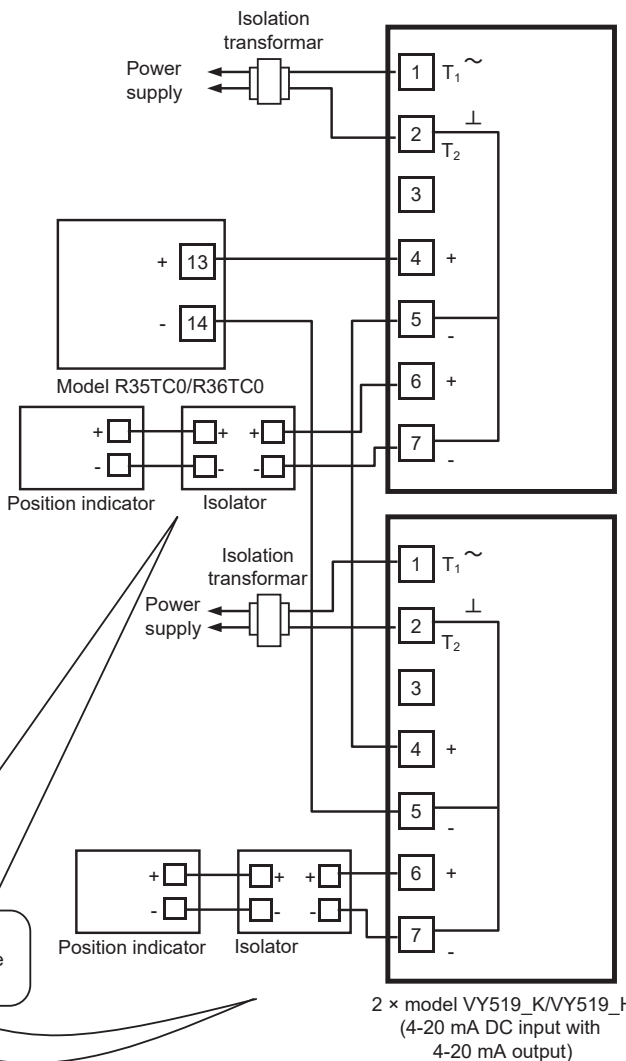

Isolation example:  
 If the position indicator is not isolated inside, provide an isolator. If isolated, an isolator is not required.

Figure 11. Connection example:  
 Two model VY519\_K/VY519\_H with model R35TC0/R36RC (parallel operation)

Notes:

- \* Input impedance of the actuator is 100 Ω
- \* For connecting multiple ACTIVAL to one controller (e.g., Model R35.36), provide a transformer (two in total) for each ACTIVAL since 4-20 mA input is not isolated from other terminals.
- \* Terminals 2, 5, and 7 are connected inside the actuator. To connect to a device (PLC, position indicator, etc.) with its terminals not isolated inside, externally isolate (between the ACTIVAL and the device). Otherwise, a loop is formed for the common line and can damage the circuit of the ACTIVAL. (R series controllers including Model R35/R36 shown in Figs. 10 and 11 are isolated inside.)
- \* Isolation transformer is required for ACTIVAL. Transformer without isolation may damage the ACTIVAL and other devices connected to ACTIVAL.



■ Internal Connection of Auxiliary Switch / Auxiliary Potentiometer

● Auxiliary switch Part No. 83174063-101

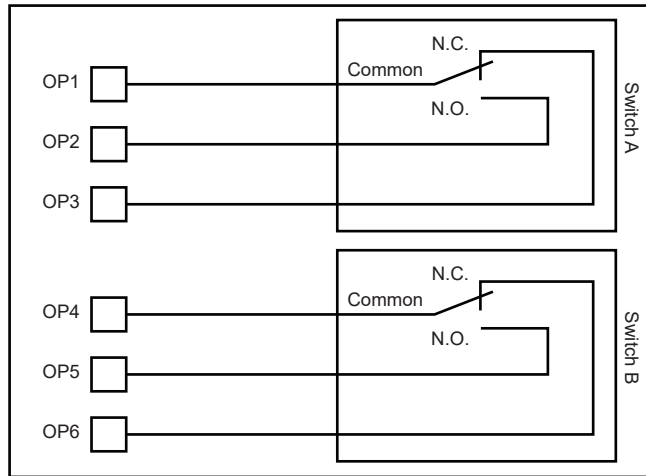

Switches A and B actuating position: Adjustable between 0 % (fully closed) and 100 % (fully open)

Figure 11 Internal connection of auxiliary switch

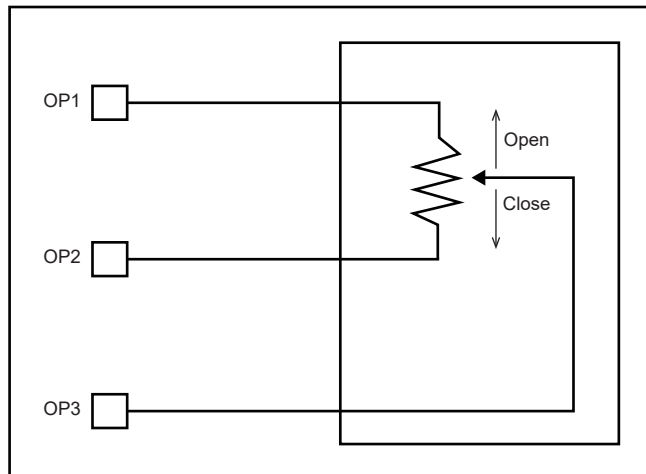

● Auxiliary potentiometer Part No. 83165275-001







Potentiometer operating position: Between 0 % (fully closed) and 100 % (fully open)

Figure 12 Internal connection of auxiliary potentiometer

■ Maintenance

⚠ WARNING	
	Before removing the actuator, fully close the valve. If you try to remove the actuator without fully closing the valve, the actuator may suddenly rotate and cause an injury.
	Do not disassemble the spring unit. The spring may fly out of the unit and cause an injury.

⚠ CAUTION	
	Do not put a load or weight on this product. Doing so may damage the product.
	Before doing maintenance, be sure to turn off the power to this product. Failure to do so may result in electric shock or device failure.
	After maintenance, be sure to reattach the cover. Failure to do so may result in electric shock.
	Do not carelessly touch this product when it is used to control hot water. Doing so may result in burns, because the product reaches a high temperature.

- Manually open/close the ACTIVAL at least once a month if it is left in inactive state for a long period.
- Inspect the ACTIVAL according to Table 5
- Visually inspect the fluid leakage of the valve and the actuator operations every six months.

If any of the problems described in Table 6 are found, take corresponding actions shown in the table. If your problem is not solved by the corresponding action, please contact Azbil Corporation near you.

Table5 Inspection items and details

Inspection item	Inspection interval	Inspection detail
Visual inspection	Semiannual	<ul style="list-style-type: none"> <li>• Fluid leakage from the gland and the flange face</li> <li>• Loosened bolts</li> <li>• Valve and actuator damages</li> </ul>
Operating status	Semiannual	<ul style="list-style-type: none"> <li>• Unstable open/close operation</li> <li>• Abnormal noise and vibration</li> </ul>
Routine inspection	Any time	<ul style="list-style-type: none"> <li>• Fluid leakage to the outside</li> <li>• Abnormal noise and vibration</li> <li>• Unstable open/close operation</li> <li>• Valve hunting</li> </ul>

Table6 Troubleshooting

Problem	Part to check	Action
Fluid leaks from the flange face.	Loosened flange bolts Gasket on the flange face Misaligned piping	Tighten the flange bolts. Replace the gasket. Redo piping.
Fluid leaks from the gland part.	—	Consult with our sales personnel.
Fluid leaks from the bonnet.	Loosened bolts	Tighten the bolts.
Valve does not operate smoothly / valve stops halfway / valve does not operate at all.	Conditions of the power applied and of the input signal applied Loosened terminals Wiring condition / disconnected wires	Check the power supply and the controller connected to. Tighten the terminals. Check the wiring.
Fluid leaks to the outside of the valve when the ACTIVAL is in fully closed position.	Actuator pointer not pointing to fully closed position	Fully close the ACTIVAL.
The valve vibrates or produces an abnormal noise	Primary pressure condition Differential pressure condition	Adjust the mounting position and change the installation location.
The auxiliary switch does not operate.	Auxiliary switch (cam switch) condition Loosened terminals Wiring condition / disconnected wires	Redo the cam switch setting. Tighten the terminals. Check the wiring.
The auxiliary potentiometer does not operate	Condition of resistance Loosened terminals Wiring condition / disconnected wires	Check the resistance value (1 k $\Omega$ ). Tighten the terminals. Check the wiring.
Valve hunting occurs.	Secondary pressure condition Differential pressure condition Control stability	Adjust the mounting position and change the installation location. Correct the control parameter setting of controller.
It takes shorter time to return the valve (from fully open to fully closed).	Check wiring for the braking motor.	Consult with our sales personnel.
It takes longer time to return the valve (from fully open to fully closed). Valve does not return.	Check the operation torque of the valve.	Consult with our sales personnel.
Valve is not fully closed by the motorized operation.	—	Consult with our sales personnel.
Input signal disagrees with the feedback output signal.	—	To completely shut off the valve, valve open and close (0-100% position) operation is controlled by 10-90 % range of actuator voltage/current input signal. Input signal therefore disagrees with the feedback signal, and this is not an error.

## ■ Disposal

### ⚠ WARNING



When handling or transporting any heavy product (more than 18 kg), carefully move the product with a hand truck or the like, or with 2 or more people.  
Careless lifting or accidental dropping of the product may result in injury or product damage.



Do not disassemble the spring unit.  
The spring may fly out of the unit and cause an injury.

Dispose of this product as industrial waste in accordance with your local regulations.  
Do not reuse all or any part of the product.



This product complies with the following harmonised standards of the Electromagnetic Compatibility Directive (EMCD).

EMCD: EN61000-6-2

EN55011 Class A, Group

ACTIVAL is a trademark of Azbil Corporation Japan or in other countries.

**Azbil Corporation**  
Building Systems Company

**azbil**

<https://www.azbil.com/>

*Specifications are subject to change without notice.*

AB-6912  
Rev. 8.0 Jun. 2021  
(J: AI-6912MJ Rev. 0.0)