

Operator Panel (Panel Mount Type) , Operator Panel (Integral Type)

■ Overview

The Operator Panel is a user terminal for displaying and setting data, which can be connected to General Controller (Model WJ-1111W0000) .

Two types, Panel mount type (Model QY5100W0000) and Integral type (Model RY5101Q0000) , are available.

The Operator Panel can display the points (ON/OFF, status, measurement, setting, etc.) in the controller and also configure the points that are settable.

By connecting the Operator Panel to the controller, it can be controlled not only through the Client PC on BMS (building management system) but also through the Operator Panel at the location where the controller is installed.

This will greatly improve the efficiency of the building management.

Additionally, the Operator Panel facilitates status indication of the devices to be controlled or monitored, and allows the controller to be easily used as standalone.

■ Features

- Displaying and setting the points
Displays and operates (sets) the points that are linked with the I/O objects belonging to the controller.
E.g.: On the Operator Panel, it is possible to control the I/O object's ON/OFF (BO) , Status (BI) , and Alarm (BI) .
The points can be displayed and operated (set) by group.
- Restricting operations
ON/OFF operation etc. for the points and setting changes through the Operator Panel can be restricted.

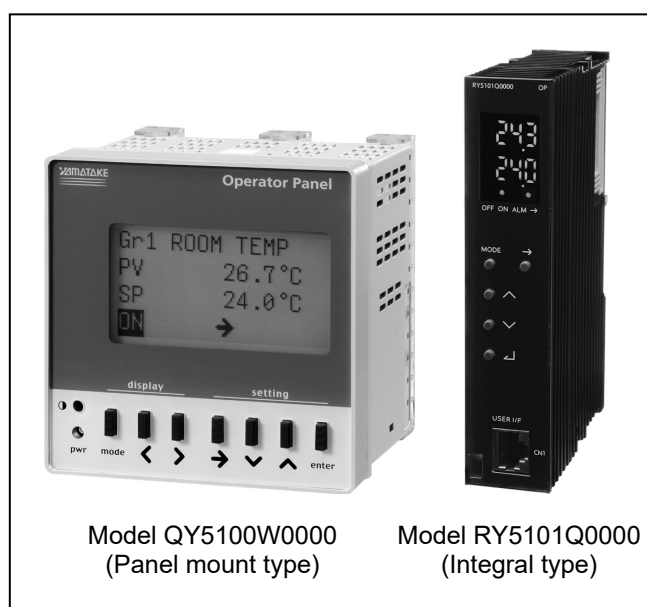

Model QY5100W0000
(Panel mount type)

Model RY5101Q0000
(Integral type)

- Functions when using the controller in standalone mode
It is possible to set an operation schedule for the point specified to continuously display its status through the Operator Panel.
Manual override function is available for the ON/OFF operation or configuring settings.
- LCD backlight and LED
The panel mount type (Model QY5100W0000) is equipped with an LCD backlight, and the integral type (Model RY5101Q0000) is equipped with a 7-segment LED.
So it is allowed to display data and setting operations even in a dark place.

Safety Precautions

Please read instructions carefully and use the product as specified in this manual.

Be sure to keep this manual nearby for quick reference.

Restrictions on Use

This product was developed, designed, and manufactured for general air conditioning use.

Do not use the product in a situation where human life may be at risk or for nuclear applications in radiation controlled areas. If you wish to use the product in a radiation controlled area, please contact Azbil Corporation.

Particularly when the product is used in the following applications where safety is required, implementation of fail-safe design, redundant design, regular maintenance, etc., should be considered in order to use the product safely and reliably.

- Safety devices for protecting the human body
- Start/stop control devices for transportation machines
- Aeronautical/aerospace machines

For system design, application design, instructions for use, or product applications, please contact Azbil Corporation.

Azbil Corporation bears no responsibility for any result, or lack of result, deriving from the customer's use of the product.

Recommended Design Life

It is recommended that this product be used within the recommended design life.

The recommended design life is the period during which you can use the product safely and reliably based on the design specifications.

If the product is used beyond this period, its failure ratio may increase due to time-related deterioration of parts, etc.

The recommended design life during which the product can operate reliably with the lowest failure ratio and least deterioration over time is estimated scientifically based on acceleration tests, endurance tests, etc., taking into consideration the operating environment, conditions, and frequency of use as basic parameters.

The recommended design life of this product is 15 years.

The recommended design life assumes that maintenance, such as replacement of the limited life parts, is carried out properly.

Refer to the section on maintenance in this manual.

Warnings and Cautions



WARNING

Alerts users that improper handling may cause death or serious injury.



CAUTION

Alerts users that improper handling may cause minor injury or material loss.

Signs



Electric shock

Alerts users to possible hazardous conditions caused by erroneous operation or erroneous use. The symbol inside \triangle indicates the specific type of danger. (For example, the sign on the left warns of the risk of electric shock.)



Disassemble

Notifies users that specific actions are prohibited to prevent possible danger. The symbol inside \otimes graphically indicates the prohibited action. (For example, the sign on the left means that disassembly is prohibited.)



General

Instructs users to carry out a specific obligatory action to prevent possible danger. The symbol inside \bullet graphically indicates the actual action to be carried out. (For example, the sign on the left indicates general instructions.)

\triangle WARNING



Electric shock

Install this product in a place, such as a control cabinet, where only the administrator has access to it. Otherwise there is a danger of electric shock.



Ground

Be sure to ground this product with a ground resistance of less than 100 Ω . Improper grounding may cause electric shock or malfunction.



Electric shock

Before wiring or maintenance, be sure to turn off the power to this product. Failure to do so may result in electric shock or device failure.





Electric shock









Before attaching or detaching the terminal cover for wiring, be sure to turn off the power to the product and all the connected devices. After the wiring work, attach the terminal cover at the original position. Failure to do so may result in electric shock.











Electric shock

Before replacement the unit, be sure to turn off the power to this product. Failure to do so may result in electric shock.

⚠ WARNING	
 Prohibition	Do not insert conductive objects through product ventilation holes. Doing so may cause electric shock.
 Electric shock	Do not touch electrically charged parts. Doing so may cause electric shock.

⚠ CAUTION	
 Fire	Take anti-lightning surge measures based on regional and building characteristics. Lightning may cause fire or critical damage to this product if protective measures are not taken.
 General	Keep this product in the package for storage. Failure to do so may damage or stain the product.
 General	Install, wire, and use this product under the conditions specified by this manual. Failure to do so may cause fire or device failure.
 General	Installation and wiring must be performed by qualified personnel in accordance with all applicable safety standards. Failure to do so may cause fire or electric shock.
 General	After installing this product, check that it is steady and does not move. Otherwise it may fall or fail.
 General	All wiring must comply with applicable codes and ordinances. Otherwise there is a danger of fire.
 General	For wiring, strip the insulation from cables as specified in this manual. If the length of exposed wire is longer than specified, it may cause electric shock or short circuit between adjacent terminals. If it is too short, it may not make proper contact.
 General	Provide a circuit breaker or a circuit protector for the power source of this product. The product does not have a power switch.

⚠ CAUTION	
 General	Take anti-noise measures if this product is installed in a location near source of electric noise. Failure to do so may cause malfunction or device failure.
 General	Connect the power supply to this product by a permanent connection means such as a connection to a terminal.
 General	Use crimp terminals with insulation for connections to the product terminals. Failure to do so may cause a short circuit leading to fire or device failure.
 Fire	Tighten the terminal screws with the specified torque. Insufficient tightening of the terminal screws may cause fire or overheating.
 Prohibition	Do not block the ventilation holes of this product. Doing so may cause device failure.
 Prohibition	Do not allow wire clippings, metal shavings, and other refuse to enter into the product. Doing so may cause fire or product damage.
 General	If more than the rated power voltage is accidentally applied to this product, replace the product with a new one for your safety. Failure to do so may cause device failure or cause fire.
 Disassemble	Do not disassemble this product. Doing so may cause device failure.
 General	Before cleaning the product, be sure to turn off the power to the product. Failure to do so may cause electric shock, device failure, or malfunction.

■ Model Numbers

Basic model number			Description
QY5100			Operator panel (panel mount type)
	W		100–240 V AC
		0000	

Note: Prepare AB-7532, *Operator Panel (Panel Mount Type) User Guide* as necessary.

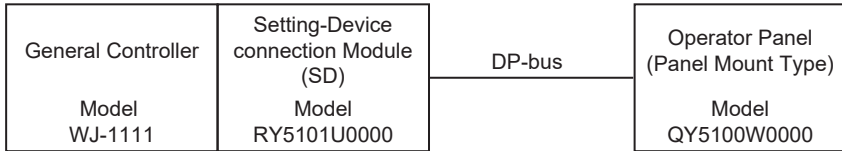

Basic model number			Description
RY5101	Q	0000	Operator panel (integral type)

Note: Prepare AB-7531, *Operator Panel (Integral Type) User Guide* as necessary.

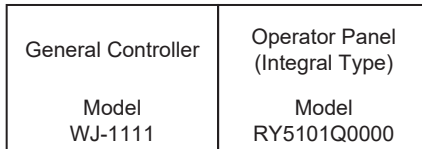

■ Specifications

● Panel Mount Type (Model QY5100W0000) Specifications

Item		Specification	
Power supply	Model QY5100W0000	Rated voltage	100–240 V AC, 50/60 Hz
		Operating voltage	85–264 V AC
		Power consumption	8 VA
Status indicator	LED	Power supply	Green lit: power ON, not lit: power OFF
Communication	DP-bus	Transmission method	RS-485
		Transmission speed	4800 bps
		Transmission distance	10 m
		Connectible units	1
Display	LCD	Resolution	128 x 64 dots
		Gradation	Black and white, 2 gradations
		Backlight	LED backlight
		Contrast adjustment	Adjustment trimmer
Input	Key	Material	Silicon rubber
		Name	[mode], [<], [>], [→], [√], [^], [enter]
Connection type	Power terminals	Terminal block: M3 screws	
	Communication (DP-bus)	Terminal block: M3 screws, modular adapter attachment (The modular adapter is connected to the terminal block in advance.)	
Main materials		Modified PPE resin	
Weight		400 g	
Environmental conditions	Rated operating conditions	Ambient temperature	0–50 °C
		Ambient humidity	10–85 % RH (without condensation)
		Altitude	2,000 m max.
		Vibration	5.9 m/s ² max. (at 10–150 Hz)
	Transport/storage conditions	Ambient temperature	-20–60 °C
		Ambient humidity	5–85 % RH (without condensation)
		Vibration (storage)	5.9 m/s ² max. (at 10–150 Hz)
		Vibration (transport)	9.8 m/s ² max. (at 10–150 Hz)
Others		<ul style="list-style-type: none"> - No corrosive gas should be detected. - The product should not be exposed to direct sunlight. - Do not let the product get wet. 	
Installation location			
Installation method		Mounted with screws	

● **Panel Mount Type (Model QY5100W0000) Wiring Specifications**

Item	Wiring	Wiring length	Condition
Power supply	IV 2.0 mm ² or CVV 2.0 mm ² or greater	—	—
Ground	IV 2.0 mm ² or CVV 2.0 mm ² or greater	—	Ground with 100 Ω or lower ground resistance
DP-bus	Cables supplied by Azbil Corporation (Model DY7210: with connectors, Model DY7220: short distance cable with connectors), or cables conforming to EIA/TIA-568 category 5e or higher	10 m	—

● **Integral Type (Model RY5101Q0000) Specifications**

Item			Specification
Power retention			Non-volatile memory
Display	7-segment LED	7-segment LED unit	4 digits x 2 rows Displayed value: Up to 6 digits (Divided into upper 2 digits and lower 4 digits) 3 digits after a decimal point
		LEDs	4 (OFF, ON, ALM, →)
Input	Key	Material	Silicon rubber
		Name	[MODE], [^], [v], [Δ], [→]
Main materials			Modified PPE resin
Weight			250 g
Environmental conditions	Rated operation conditions	Ambient temperature	0–50 °C
		Ambient humidity	10–90 % RH (without condensation)
		Altitude	2,000 m max.
		Vibration	3.2 m/s ² max. (at 10–150 Hz)
	Transport/storage conditions	Ambient temperature	-20–60 °C
		Ambient humidity	5–95 % RH (without condensation)
		Vibration (storage)	3.2 m/s ² max. (at 10–150 Hz)
		Vibration (transport)	9.8 m/s ² max. (at 10–150 Hz)
	Others		- No corrosive gas should be detected. - The product should not be exposed to direct sunlight. - Do not let the product get wet.
	Installation location		
Installation method			Mounted on a DIN rail, or mounted with screws

● **Integral Type (Model RY5101Q0000) Wiring Specifications**

Item	Wiring	Wiring length	Condition
USER I/F	Cables supplied by Azbil Corporation (Model DY7210: with connectors, Model DY7220: short distance cable with connectors), or cables conforming to EIA/TIA-568 category 5e or higher	50m	—

■ Dimensions

● Panel Mount Type (Model QY5100W0000) Dimensions

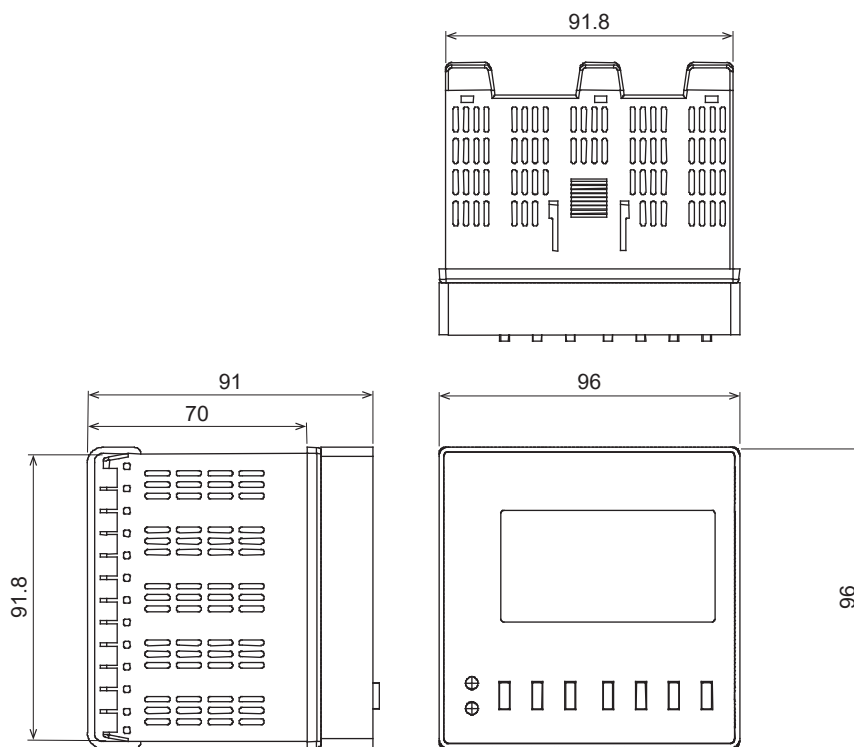

Figure 1. Dimensions (panel mount type) (mm)

● Integral Type (Model RY5101Q0000) Dimensions

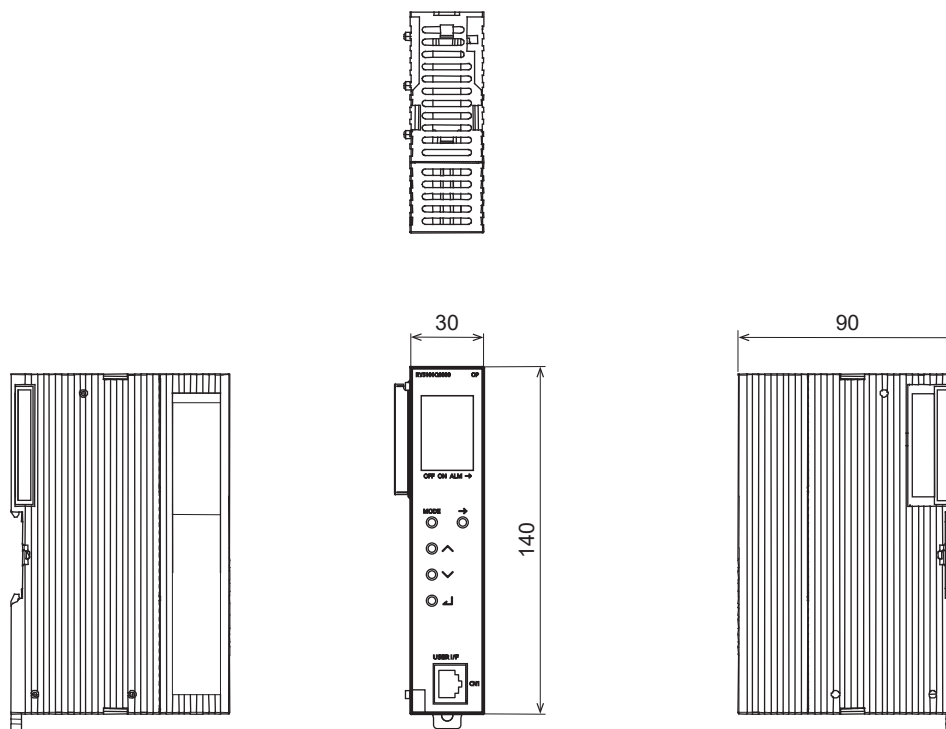

Figure 2. Dimensions (integral type) (mm)

● Panel Mount Type (Model QY5100W0000) Panel Drilling Dimensions

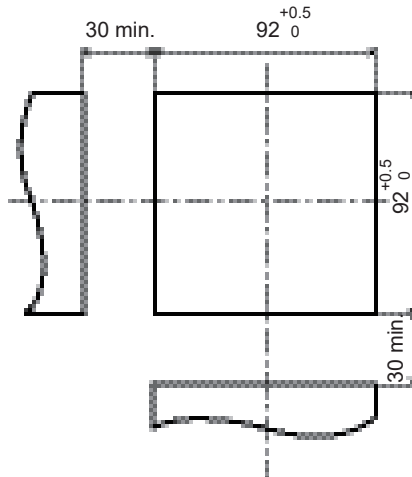
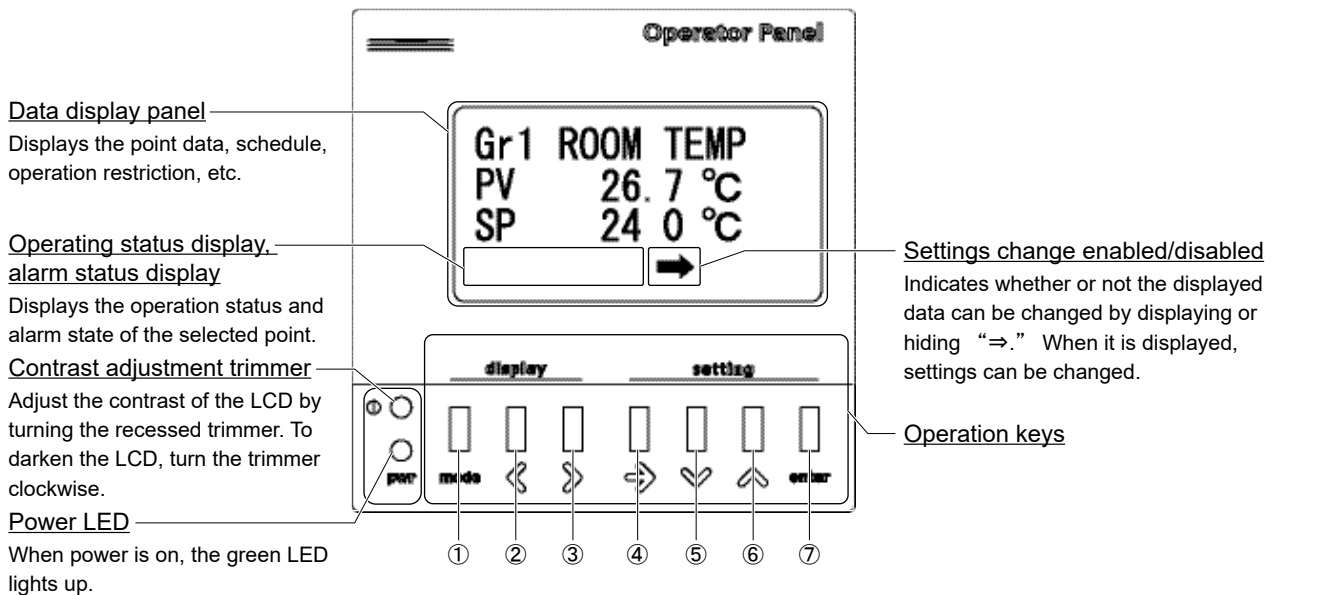

Figure 3. Panel drilling dimensions (panel mount type) (mm)

■ Parts Identification

● Panel Mount Type (Model QY5100W0000)



- (1) : [mode] key Switches the point display mode.
- (2) : [<] key Switches the point data display to the previous one.
- (3) : [>] key Switches the point data display to the following one.
- (4) : [→] key Switches from the normal display mode to the setting changeable mode. In the setting changeable mode, move the digit of the setting value and select the digit to be changed.
- (5) : [v] key For changing the numeric value, press the key to decrease the value from 9 to 0 by 1 each time pressing it. For switching ON/OFF, changes "ON" to "OFF."
- (6) : [^] key For changing the numeric value, press the key to increase the value from 0 to 9 by 1 each time pressing it. For switching ON/OFF, changes "OFF" to "ON." For switching the sign, changes "-" to "+".
- (7) : [enter] key Settles the setting value. Press and hold the key with the [mode] key simultaneously to switch to the setting mode. In the setting mode, it is possible to enable or disable the ON/OFF or setting change operations.

Figure 4. Parts identification (panel mount type)

● Integral Type (Model RY5101Q0000)

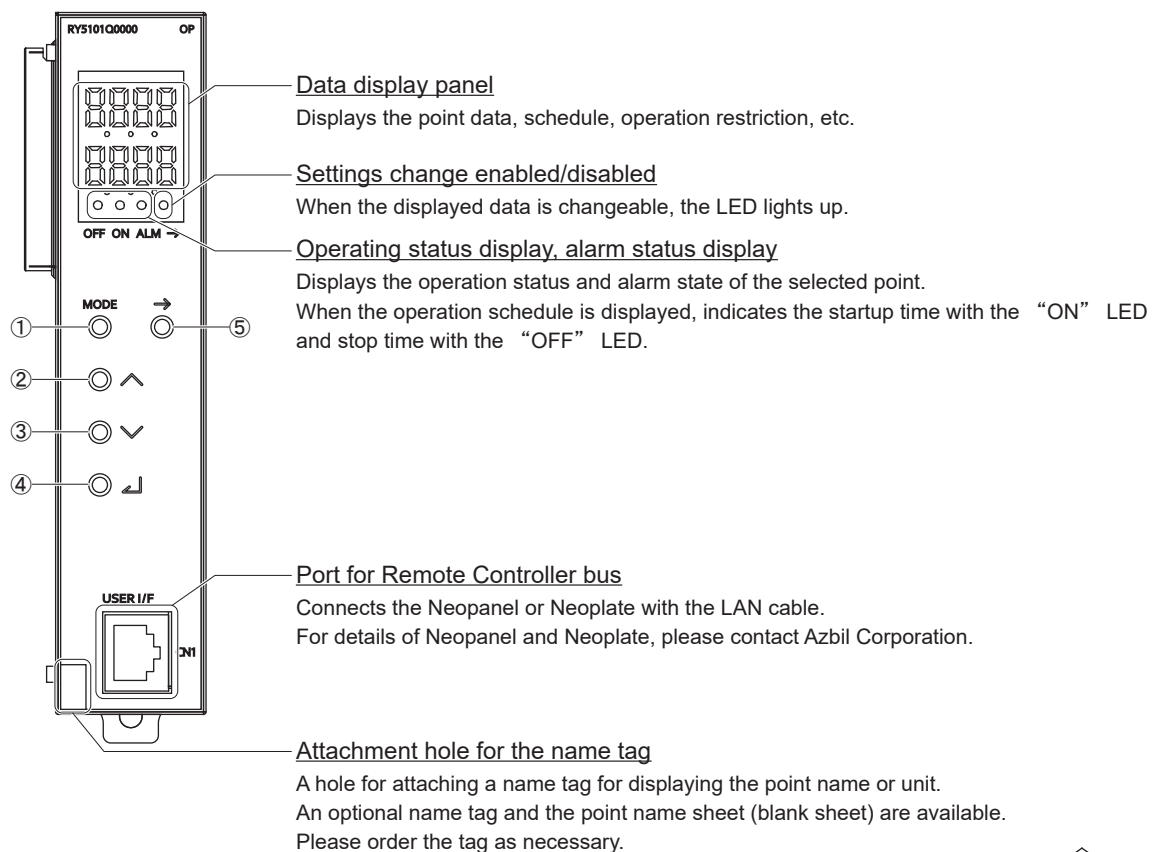

Name tag set (Model 83167015-001)
The point name sheet is attached with AB-7531, Operator Panel (Integral Type) User Guide.
Make a photocopy of the sheet and fill in the point name.
Note: Excel data sheet is also available. For details, please contact Azbil Corporation.

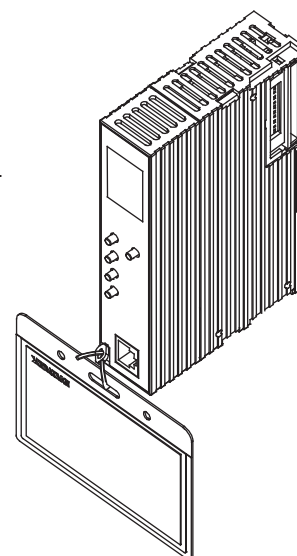



- (1) : [MODE] key Switches the point display mode.
- (2) : [↑] key Switches the point data display to the previous one. (Setting changeable mode)
For changing the numeric value, press the key to increase the value from 0 to 9 by 1 each time pressing it.
For switching ON/OFF, changes “OFF” to “ON.” For switching the sign, changes “-” to “+.”
- (3) : [↓] key Switches the point data display to the following one. (Setting changeable mode)
For changing the numeric value, press the key to decrease the value from 9 to 0 by 1 each time pressing it.
For switching ON/OFF, changes “ON” to “OFF.” For switching the sign, changes “+” to “-.”
- (4) : [↵] key Settles the setting value.
Press and hold the key with the [MODE] key simultaneously to switch to the setting mode. In the setting mode, it is possible to enable or disable the ON/OFF or setting change operations.
- (5) : [→] key Switches from the normal display mode to the setting changeable mode.
In the setting changeable mode, move the digit of the setting value and select the digit to be changed.

Figure 5. Parts identification (integral type)

■ Installation

⚠ WARNING	
 Electric shock	Install this product in a place, such as a control cabinet, where only the administrator has access to it. Failure to do so may result in electric shock.

⚠ CAUTION	
 General	Install, wire, and use this product under the conditions specified by this manual. Failure to do so may cause fire or device failure.
 General	Installation and wiring must be performed by qualified personnel in accordance with all applicable safety standards. Failure to do so may cause fire or electric shock.
 General	After installing this product, check that it is steady and does not move. Otherwise it may fall or fail.

<p>IMPORTANT • Do not install the operator panel at the high temperature place where the radiant heat from the central plant equipment or the direct sunlight strikes directly, or where the display is difficult to see. It is not waterproofed, so do not install it at the place where rain or water drops.</p>

● Panel Mount Type (Model QY5100W0000)

Precautions for installation

- Use the panel made of a steel plate of 2 mm or more in thickness.
- The mounting angle must be 10 degrees tilted downward or upward from the horizontal position.
- The viewing angle is 80 degrees both vertically and horizontally. Install the product in the position considering visibility.
- Do not remove the protective sheet until the wiring work is completed.
- When installing (with the lid closed) Secure a space of 10 mm or more from the surface of terminal cover.

Installation method

- (1) Insert the product from the front of the panel.
- (2) Attach the mounting brackets from the back of the panel.
- (3) Press the panel onto the panel until the hooks on the mounting brackets securely fit into the grooves on the main unit.
- (4) Tighten the screws on the top and bottom mounting brackets.

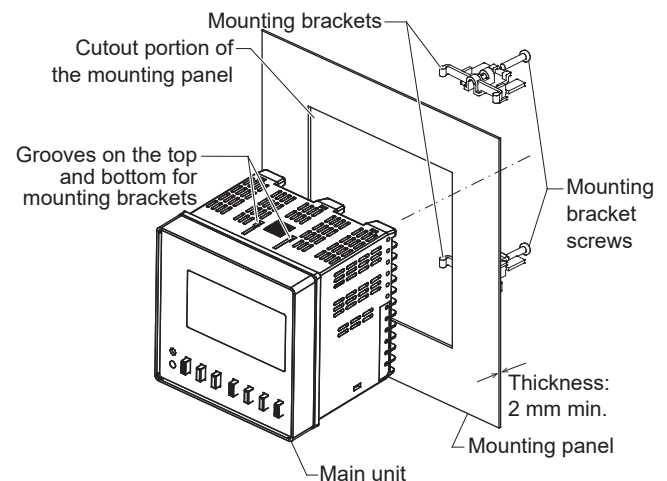

<p>IMPORTANT • To fasten the product onto the panel, tighten the mounting bracket screws provided with the product, and turn one more turn when there is no play between the bracket and panel. If you tighten the screws too much, the case may be deformed.</p>
--







● Integral Type (Model RY5101Q0000)

For installation and maintenance space, refer to AB-7453, *Direct Mount I/O Modules and SAnet Interface Module Specifications/Instructions*, AB-7456, *General Controller Specifications/Instructions*.

■ Wiring

⚠ WARNING	
 Ground	<p>Be sure to ground this product with a ground resistance of less than 100 Ω. Improper grounding may cause electric shock or malfunction.</p>
 Electric shock	<p>Before wiring, be sure to turn off the power to this product. Failure to do so may result in electric shock or device failure.</p>

⚠ CAUTION	
 General	<p>Installation and wiring must be performed by qualified personnel in accordance with all applicable safety standards. Failure to do so may cause fire or electric shock.</p>
 General	<p>All wiring must comply with applicable codes and ordinances. Otherwise there is a danger of fire.</p>
 General	<p>Provide a circuit breaker or a circuit protector for the power source of this product. The product does not have a power switch.</p>
 General	<p>Take anti-noise measures if this product is installed in a location near source of electric noise. Failure to do so may cause malfunction or device failure.</p>
 Fire	<p>Tighten the terminal screws with the specified torque. Insufficient tightening of the terminal screws may cause fire or overheating.</p>

<p>IMPORTANT</p>	<ul style="list-style-type: none"> • Use the crimp terminal lugs with an outer diameter of 5.8 mm or less. • The power terminals should not be fastened together with other terminals. Daisy chain wiring is not allowed for this product using its terminal blocks. • The recommended tightening torque for the power terminal screws is 0.618 N·m.
-------------------------	---

● Panel Mount Type (Model QY5100W0000)

- (1) Connect wires to the power terminal block. Connect the SD module and this product with the modular cable.

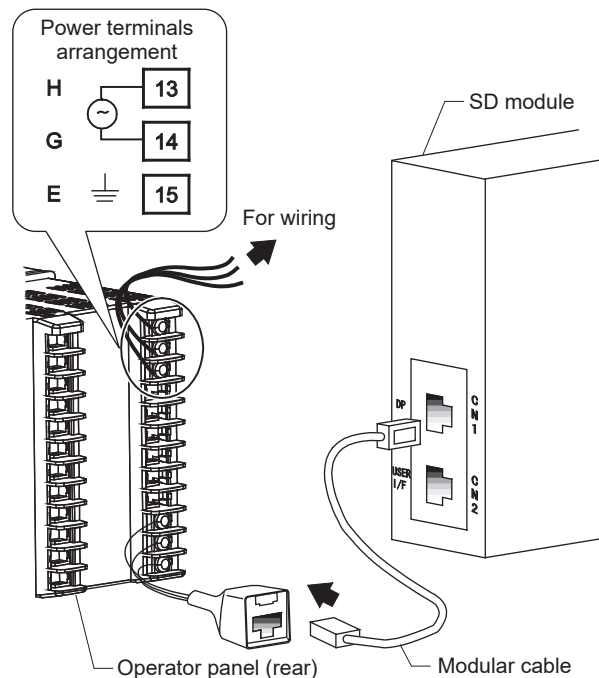

Figure 6. How to connect the SD module

- (2) After wiring, be sure to peel off the protective sheets on the panel surface and the top of the main unit before turning on the power.

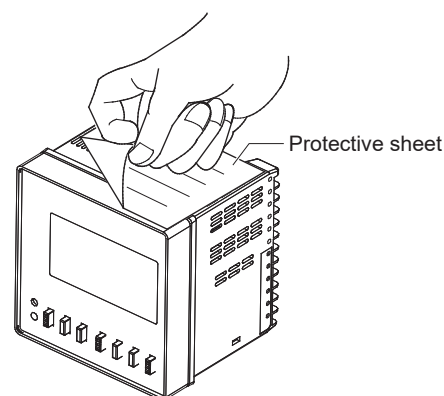

Figure 7. Protective sheet

● Integral Type (Model RY5101Q0000)

The operator panel (integral type) can be installed with the same procedure as the direct mount I/O module.



For installation, refer to AB-7453, *Direct Mount I/O Modules and SAnet Interface Module Specifications/Instructions*, AB-7456, *General Controller Specifications/Instructions*.

■ Notes for Configuration

For configuring the operator panel (integration type), refer to AB-7453, *Direct Mount I/O Modules and SAnet Interface Module Specifications/Instructions*.

■ Functions

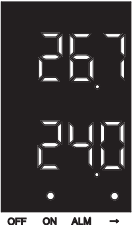
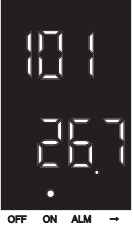
(1/2)

Function		Description
Common functions when connected to the system or to the standalone controller	Points display, setting functions	<p>Group display, setting mode</p> <p>In this mode, displays the grouped points. Up to 4 groups can be configured, and up to 16 points per group can be registered in any order. Up to two points can be displayed simultaneously. When displaying the group top, No. 1 and No. 2 points are displayed. When scrolling, one point is displayed. It is also possible to configure the points that are settable.</p> <div style="display: flex; justify-content: space-around;"> <div style="border: 1px solid black; padding: 5px; width: 150px;"> <p>Gr1 ROOM TEMP PV 26.7 °C SP 24.0 °C ON →</p> </div>  </div> <div style="display: flex; justify-content: space-around; margin-top: 10px;"> <div style="text-align: center;"> <p>Group top display (Panel mount type)</p> </div> <div style="text-align: center;"> <p>Group top display (Integral type)</p> </div> </div> <div style="display: flex; justify-content: space-around; margin-top: 10px;"> <div style="border: 1px solid black; padding: 5px; width: 150px;"> <p>Gr1 ROOM TEMP 01 PV 26.7 °C ON</p> </div>  </div> <div style="display: flex; justify-content: space-around; margin-top: 10px;"> <div style="text-align: center;"> <p>Group scroll display (Panel mount type)</p> </div> <div style="text-align: center;"> <p>Group scroll display (Integral type)</p> </div> </div>
	All points display, setting mode	<p>Displays and operates (sets) the points that are linked with the I/O objects belonging to the controller. Up to 99 points can be controlled. Only one point can be displayed at one time. It is also possible to configure the points that are settable.</p> <div style="display: flex; justify-content: space-around;"> <div style="border: 1px solid black; padding: 5px; width: 150px;"> <p>Gr0 01 PV 26.7 °C ON</p> </div>  </div> <div style="display: flex; justify-content: space-around; margin-top: 10px;"> <div style="text-align: center;"> <p>(Panel mount type)</p> </div> <div style="text-align: center;"> <p>(Integral type)</p> </div> </div>

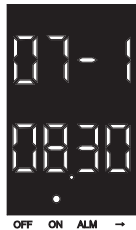
Function		Description
Common functions when connected to the system or to the standalone controller	Points display, setting functions	<p>Operating status display, alarm status display</p> <p>You can specify one point from the ON/OFF points or alarm points, the status of the specified point is displayed at the bottom of the screen.</p> <div style="display: flex; justify-content: space-around; align-items: center;"> <div style="border: 1px solid black; padding: 5px; text-align: center;"> <p>Gr1 ROOM TEMP 02 SP 24.0 °C ON ALM →</p> </div> <div style="text-align: center;">  <p>OFF ON ALM →</p> </div> </div> <p>(Panel mount type) (Integral type)</p> <p>The figure above indicates that the operating status is “ON” and the alarm status is “reported.” Panel mount type: When the operating status is “OFF” or the alarm status is “not reported,” does not display the status. Integral type: When the operating status is “OFF,” the dot above [OFF] lights up and above [ON] turns off. When the alarm status is “not reported,” the dot above [ALM] turns off.</p>
	Displaying group name, abbreviated point name, and engineering units (only for panel mount type)	<p>Displays the group name to which the points belong, the abbreviated point name for identification, engineering units, etc. Note that an abbreviated point name is displayed using up to 4 alphanumeric characters, and a group name is up to 12 alphanumeric characters.</p>
	Operation restrictions	<p>It is possible to enable or disable the ON/OFF or setting change operations. This function is used to prevent careless configuration changes or undesirable ON/OFF operation.</p>
Functions when using the controller in standalone mode	Schedule display*	<p>Displays the operation schedules for the current and following days.</p> <div style="display: flex; justify-content: space-around; align-items: center;"> <div style="border: 1px solid black; padding: 5px; text-align: center;"> <p><SCHEDULE CHK> 07-1 8:30 ON</p> </div> <div style="text-align: center;">  <p>OFF ON ALM →</p> </div> </div> <p>(Panel mount type) (Integral type)</p>
	Schedule setting*	<p>Operation schedule</p> <p>You can set the operation schedule using the operator panel. Up to 8 schedules per day can be displayed for 8 days of the week (Monday through Sunday and one holiday) , or be set starting from 0:01 minute.</p>
		<p>Holiday setting and displaying</p> <p>Displays or sets the dates to which the holiday operation schedule is applied.</p>
	Date & time setting	<p>Sets year, month, day, hour, and minute.</p>
	Manual override	<p>For inspection and maintenance, manual operation and setting can be set to override the output signals from the controller.</p>

* Schedule display and setting functions are applicable only to the ON/OFF point specified to continuously display its status. If an alarm point is specified, the functions are not applicable.

Table 1. Points to be continuously displayed on the screen and items displayed

Point type	Operating status	Alarm status
Status (BI) / Alarm (BI)	Yes	Yes
ON/OFF (BO) / Status (BI) / Alarm (BI)	Yes*2	Yes
Status (BI) *1	Yes	—
ON/OFF (MO)	Yes	—
ON/OFF (BO) / Status (BI)	Yes*2	—
Alarm (BI)	—	Yes

*1 Status points are also applicable.

*2 For the unmatched of COS for the ON/OFF (BO) / Status (BI) and ON/OFF (BO) / Status (BI) / Alarm (BI), the status is indicated by turning on or off of the [ON] or [OFF] indicator.

Maintenance

⚠ WARNING	
	<p>Before doing maintenance, be sure to turn off the power to this product.</p> <p>Failure to do so may result in electric shock or device failure.</p>
Electric shock	

● Panel Mount Type (Model QY5100W000)

To clean the LCD surface, wipe it with a dry soft cloth. This product does not require regular parts replacement. If the brightness or contrast of the LCD deteriorates, replace the LCD module. If the fuse blows out or other parts fail, replace the whole product.

Table 2. Replacement parts

Symptom	Replacement part
Deterioration of the LCD's brightness or contrast	LCD module Model 83167012-001
Blown fuse	Whole product
Others	Whole product

- IMPORTANT**
- Only authorized service personnel are allowed to replace the parts.
 - Do not touch the power supply part during replacement work.
 - Before replacement work, be sure to turn off the power to this product.
 - Since plastic screws are used to prevent static electricity, be sure not to excessively tighten them so as not to break the screws.
Metal screws cannot be substituted for the plastic screws.
 - Be sure to discharge static electricity charged in your body (by touching the unpainted metal part of the panel, etc.) before handling the LCD module. Do this regularly while working to eliminate static electricity from your body.

LCD module replacement

Tools:

- Flathead screwdriver
- Phillips screwdriver (size: #0)

(1) Remove the front plate using a flathead screwdriver.

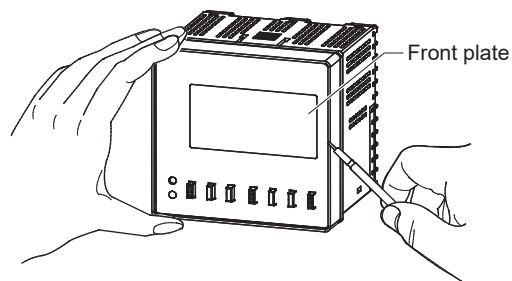

Figure 8. Front plate removal

(2) Remove the transparent cover. Insert fingers in the clearance between the cover and the frame to pull the cover out. When the transparent cover comes out a little, grab it with your fingers and remove it.

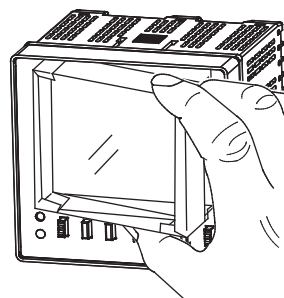

Figure 9. Transparent cover removal

(3) Unscrew the 1 screw at the bottom left of the LCD board.

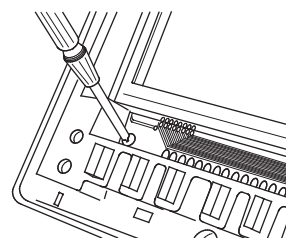

Figure 10. Screw removal

- (4) Detach the upper portion of the LCD module. At this time, note that the LCD module is connected to the LCD board with a connector.

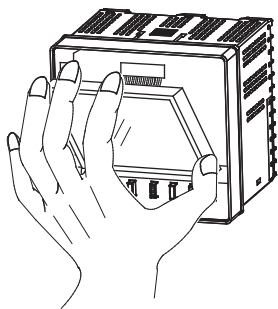

Figure 11. LCD module removal

- (5) Detach the connector to remove the LCD module.

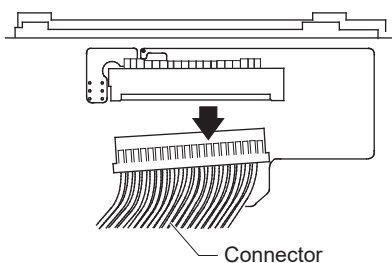

Figure 12. Connector detachment

- (6) Mount a new LCD module.
Connect the connector and hook the LCD module with the hooks on the LC board. Insert the screw into the hole located at the bottom of the LCD board, and then engage the screw with the boss at the bottom right of the LCD board.

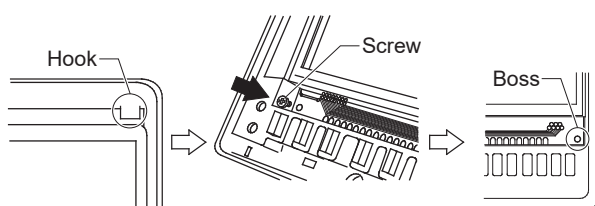

Figure 13. LCD module mounting

- (7) When the LCD module fits to the LCD board, tighten the screw at the bottom left of the LCD board (in one location).

IMPORTANT • The recommended tightening torque is 0.07 N·m.
Be sure not to excessively tighten the screw so as not to break it.

- (8) Attach the transparent cover to the LCD module.
(The wider side needs to be located on the right.)
- (9) Attach the front plate.

● Integral Type (Model RY5101Q0000)

For the integral type, the whole unit should be replaced.
For details, please contact Azbil Corporation.

■ Disposal

When this product is no longer used, dispose of this product as industrial waste in accordance with your local regulations.
Do not reuse all or any part of the product.

CE Install this product in a panel cabinet.
Additionally, always keep the panel cabinet accessible only to people with sufficient knowledge concerning electrical equipment.

This product complies with the following harmonised standards of the Electromagnetic Compatibility Directive (EMCD) and the Low Voltage Directive (LVD) .

EMCD: EN 61326-1 Class A, Table 2 (for use in an industrial electromagnetic environment)

LVD: EN 61010-1 Overvoltage category II

Pollution degree 2

The operator panel (integral type) RY5101Q0000 does not conform to CE marking.

Azbil Corporation
Building Systems Company

azbil

<https://www.azbil.com/>

Specifications are subject to change without notice.