

Natural Gas Calorimeter

Model CVM400

OVERVIEW

The Model CVM400 Natural Gas Calorimeter measures the thermal conductivity of a gas mixture such as natural gas at different temperatures and calculates the calorific value of the gas based on its thermal conductivity. Drawing upon expertise in gas analysis and gas calorific value measurement accumulated for more than 20 years since the release of the first Smart Gas Chromatograph, Azbil Corporation now offers compact, lightweight, and high-precision natural gas calorimeters that comply with international legal metrology standards.

FEATURES

- (1) OIML R 140 compliant device. Can be used as a calorimeter or calorific value determining device (CVDD) for natural gas. (OIML R140: International Organization of Legal Metrology recommendation that includes specifications for CVDDs.)
- (2) Innovative structure compatible with various installation sites
 - Unlike conventional gas calorimeters, the CVM400 is small and lightweight, allowing a variety of installation site choices.
 - Explosion-proof: compliant with IECEx and ATEX, and suitable for Zone 1 use
- (3) Revolutionary continuous measurement. Can detect a change of calorific value in processes in near real time by measuring every 2 seconds.
- (4) Fast response (sample flow rate: 50 ml/min)
 - Natural gas model: 5 seconds (When calorific value changes more than 0.7 MJ/m³)
 - OIML model: 30 seconds
 - LNG model: 5 seconds

Response time is defined as the time output signal changes to 90 %.
- (5) Automatic calibration for prolonged stability. Automatic calibration using pure methane guarantees long-term stable operation.
- (6) A wealth of diagnostic functions
 - Ambient temperature diagnostic function. Determines whether the operating environment is suitable, making use of a temperature sensor embedded on the same chip as the thermal conductivity sensor.
 - Operation time tracker function. Keeps track of the total operation time for comparison with the recommended replacement period (70000 hours) for the calorimeter.
 - Automatic calibration history check function. Shows up to 5 of the latest automatic calibration records to check changes in the calibration factor.

MEASUREMENT PRINCIPLE

The CVM400 measures the thermal conductivity of natural gas at different temperatures, changing the temperature of the thermal conductivity sensor in multiple stages. The calorimeter uses the support vector regression (SVR) method that is also employed on Azbil Corporation's differential pressure transmitters. The calorific value is calculated from the measured thermal conductivity values of the process using a characteristics formula created in advance based on thermal conductivities measured at different temperatures of the natural gas.



STANDARD SPECIFICATIONS

Instrument

- Process gas connection port: NPT 1/8 (F), Rc 1/8
- Electrical conduit: NPT 1/2 (F), M20
- Case structure: IEC IP66
- Flame-proof structure:
- ATEX: II 2G Ex db II B T6 Gb;
II 2D Ex tb IIIC T80 °C Db
 - IECEx: Ex db IIB T6 Gb, Ex tb IIIC T80 °C Db
 - TIIS: Ex d IIB T6X
 - KCs: Ex d IIB T6
 - NEPSI: Exd IIB T6 Gb, ExtD A21 IP66 T80 °C
- Display: LCD
- Automatic calibration setting display:
● and ○ light up alternately when set.
- Calibration factor display: a flag is shown if calibration fails
- Communications: HART protocol ver. 7.0 (with CommStaff and HART 475 Communicator)
- Power: 24 Vdc ±10 %, 0.3 A max. (inrush current at startup)
- Output: Analog output: 4–20 mAdc
- Contact output: 24 Vdc ±10 %, 50 mA max. (transistor contact for status); 24 Vdc ±10 %, 1 A max. (transistor contact for calibration)
- Paint: Baked acrylic resin finish
- Color:
- Housing: Light beige
 - Front cover: Dark beige
 - Terminal cover: dark beige

Material

Case material:

Housing: aluminum alloy (ADC 12)
 Front cover: aluminum alloy (ADC 12)
 Terminal cover: aluminum alloy (ADC 12)
 Window: reinforced glass
 Cover O-ring: NBR rubber

Wet parts materials:

Manifold: 304 stainless steel
 Adapter: 304 stainless steel
 μTCD sensor: platinum, glass, gold, Kovar, silicon
 O-ring: Fluoro rubber

Process gas specifications:

Temperature: -10 to +50 °C
 Pressure: 110 kPa (abs) max. (at Model CVM400 process connection port inlet)
 Flow rate: 50 ±10 ml/min
 Dust: Less than 1 μm in diameter, 1 mg/m³ max.
 Mist: none at -20 °C
 Moisture: dew-point temperature -20 °C max.

Calibration conditions:

Calibration: Automatic/Manual
 Calibration gas: Pure methane (99.995 purity min.)

Installation conditions:

Ambient temperature: -10 to +50 °C
 Ambient humidity: 95 % RH max.
 Mass: 2.5 kg

Table1. Acceptable limits of components/Unit: mol%

Gas type		Natural gas						LNG					
		Code A Natural Gas	Code F OIML R140	Code Q Natural Gas (Methane Number)	Code L Natural gas (G-gas)	Code M Natural gas (B-gas)	Code N Bio gas	Code G LNG	Code H LNG 13A C3 Base gas	Code J LNG 13A	Code K LNG 13A C4 Base gas	Code R LNG (Methane Number)	Code S LNG for ship
CH ₄ (C1)	Methane	80 to 100	82 to 100	80 to 100	65 to 85	77 to 100	40 to 100	85 to 100	86 to 93	86 to 100	86 to 93	82 to 100	80 to 100
C ₂ H ₆ (C2)	Ethane	0 to 11	0 to 11	0 to 11	0 to 11	0 to 4	0	0 to 9 *9 to 14	0 to 7	0 to 7	2 to 6	0 to 15	0 to 16
C ₃ H ₈ (C3)	Propane	0 to 5	0 to 5	0 to 5	0 to 3.5	0 to 1	0	0 to 4	0 to 8	0 to 9	0 to 4	0 to 3	0 to 9
C ₄ +(C4)	Butane +higher alkanes	0 to 2	0 to 1.2	0 to 2	0 to 1.2	0 to 0.5	0	0 to 2	0 to 2	0 to 2	2 to 5	0 to 2 *0 to 1.5	0 to 3
N ₂	Nitrogen	0 to 7	0 to 7	0 to 5	10 to 20	0 to 15	0 to 60	0 to 1	0 to 0.2	0 to 1	0 to 0.2	0 to 10	0 to 16
CO ₂	Carbon Dioxide	0 to 2	0 to 1.8	0 to 1.2	0 to 1.8	1 to 2.5	0 to 60	0	0	0	0	0	0
Condition		C1>C2≥C3≥C4 (C3≤0.4×C2, C4≤0.6×C3) • CO ₂ ≥1.0→ C4≥0.3 • C4-CO2 ≤ 0.6% (Except in case C4>1 and C4≤2×CO ₂)			C2≥C3 C2≥C4 *Special model		*Special model	• C1>C2≥C3≥C4 • 0.7×C2≥C3≥ 0.2×C2 and 0.7×C3≥C4 • C1<95> N2 : 0 to 0.2	C1>C2≥C4	C1>C2≥C4		• C1>C2≥C3≥C4 • C5+<0.03 *In case code M of output units, C2≠0, C3≠0 *In case code N of output units C4+ : 0 to 1.5	

Table2. Performance/Unit : % reading. Code Q,R: Absolute error

Gas type		Natural gas						LNG						
		Code A Natural Gas	Code F OIML R140	Code Q Natural Gas (Methane Number)	Code L Natural gas (G-gas)	Code M Natural gas (B-gas)	Code N Bio gas	Code G LNG	Code H LNG 13A C3 Base gas	Code J LNG 13A	Code K LNG 13A C4 Base gas	Code R LNG (Methane Number)	Code S LNG for ship	
Accuracy (Reading)		*1	±1.5%	±1%	±3	±2.0%	±1.5%	±2.0%	±1%	±1%	±1.2%	±1%	±2	±1%
Repeatability		*2	±0.2%	±0.2%	±0.3	±0.2%	±0.2%	±0.2%	±0.2%	±0.2%	±0.2%	±0.2%	±0.3	±0.2%
Variations*2	Ambient temp.	*3	±0.2%	±0.3%	±0.5	±0.3%	±0.2%	±0.2%	±0.2%	±0.2%	±0.2%	±0.2%	±0.5	±0.2%
	Atmospheric press.	*4	±0.2%	±0.2%	±0.5	±0.3%	±0.2%	±0.2%	±0.2%	±0.2%	±0.2%	±0.2%	±0.5	±0.3%
	Sample gas flow	*5	±0.2%	±0.2%	±0.5	±0.2%	±0.2%	±0.2%	±0.2%	±0.2%	±0.2%	±0.2%	±0.5	±0.2%

*1: Accuracy=(Trueness)+(Repeatability)

- Trueness is the proximity of measurement results to the true value.
- True value is the value calculated by following method.

Calorific value(SCV,ICV,WI): Calculated by the components according to ISO6976:1998.

Methane Number(MN): Calculated by the components using the software made by Azbil, according to the standard CEN EN 16726, or according to CARB/GRI method.

CARB/GRI method

$$\text{Methane Number} = 1.624 \times (-406.14 + 508.04 \times \text{RHCR} - 173.55 \times \text{RHCR}^2 + 20.17 \times \text{RHCR}^3) - 119.1$$

$$\text{RHCR} = \frac{(\text{CH}_4 \times 4 + \text{C}_2\text{H}_6 \times 6 + \text{C}_3\text{H}_8 \times 8 + (i - \text{C}_4\text{H}_{10} + n - \text{C}_4\text{H}_{10}) \times 10 + (i - \text{C}_5\text{H}_{12} + n - \text{C}_5\text{H}_{12}) \times 12 + (\text{C}_6\text{H}_{14} \text{ or higher } \times 14))}{(\text{CH}_4 \times 1 + \text{C}_2\text{H}_6 \times 2 + \text{C}_3\text{H}_8 \times 3 + (i - \text{C}_4\text{H}_{10} + n - \text{C}_4\text{H}_{10}) \times 4 + (i - \text{C}_5\text{H}_{12} + n - \text{C}_5\text{H}_{12}) \times 5 + (\text{C}_6\text{H}_{14} \text{ or higher } \times 6))}$$

*2: Repeatability=σ*2√2. σ: Standard deviations of the measurement value.

*3: Ambient temperature effect per 30 °C change. Range from -10 to +50 °C.

*4: Static pressure effect per 30 hPa change. Range from 983 to 1043 hPa.

*5: Sampling gas flow rate effect per 10 ml/min change. Range from 40 to 60 ml/min.

*6: These performance do not include the effect of PV trim.

Table3. Output range (LRV-URV)/Unit: MJ/m³ *Code Q,R:No unit

Gas calorific value calculation parameters		Gas type		Natural gas					
				Code A Natural Gas	Code F OIML R140	Code Q Natural Gas (Methane Number)	Code L Natural gas (G-gas)	Code M Natural gas (B-gas)	Code N Bio gas
1	15 °C/15 °C	1	SCV(MJ/m ³)	35-45	35-45		25-41	30-42	14-40
		4	WI_Hs(MJ/m ³)	44-54			36-52	38-52	
4	20 °C/20 °C	7	ICV(MJ/m ³)	31-41					
		A	WI_Hi(MJ/m ³)	40-50					
6	25 °C/20 °C	D	SCV(MJ/kg)						
		F	ICV(MJ/kg)						
2	0 °C/ 0 °C	1	SCV(MJ/m ³)	37-47					14-40
		4	WI_Hs(MJ/m ³)	48-58					
3	25 °C/ 0 °C	7	ICV(MJ/m ³)	33-43					
		A	WI_Hi(MJ/m ³)	43-53					
5	15 °C/ 0 °C	D	SCV(MJ/kg)						
		F	ICV(MJ/kg)						
X	Unspecified	M	MN(CEN) --			60-110			
		N	MN(CARB/ GRI) --			60-110			

Gas calorific value calculation parameters		Gas type		LNG					
				Code G LNG	Code H LNG 13A C3 Base gas	Code J LNG 13A	Code K LNG 13A C4 Base gas	Code R LNG (Methane Number)	Code S LNG for ship
1	15 °C/15 °C	1	SCV(MJ/m ³)	37-47	37-47	37-47	37-47		
		4	WI_Hs(MJ/m ³)	48-58	48-58	48-58	48-58		
4	20 °C/20 °C	7	ICV(MJ/m ³)	33-43	33-43	33-43	33-43		
		A	WI_Hi(MJ/m ³)	43-53	43-53	43-53	43-53		
6	25 °C/20 °C	D	SCV(MJ/kg)						41-56
		F	ICV(MJ/kg)						37-51
2	0 °C/ 0 °C	1	SCV(MJ/m ³)	39-49	39-49	39-49	39-49		
		4	WI_Hs(MJ/m ³)	50-60	50-60	50-60	50-60		
3	25 °C/ 0 °C	7	ICV(MJ/m ³)	35-45	35-45	35-45	35-45		
		A	WI_Hi(MJ/m ³)	45-55	45-55	45-55	45-55		
5	15 °C/ 0 °C	D	SCV(MJ/kg)						41-56
		F	ICV(MJ/kg)						37-51
X	Unspecified	M	MN(CEN) --					60-110	
		N	MN(CARB/ GRI) --					60-110	

SCV: Superior Calorific Value: MJ/m³, MJ/kg

WI_Hs: Wobbe Index (SCV/√Relative density) MJ/m³

ICV: Inferior Calorific Value: MJ/m³, MJ/kg





WI_Hi: Wobbe Index (ICV/√Relative Density): MJ/m³







MN(CEN): Methane Number, according to European Committee for standard "EN 16726".

MN(CARB/GRI): Methane Number, according to CARB/GRI method.



Handling Precautions for This Product





Installation Precautions



 WARNING	
	When installing, use proper fittings and proper tightening torque for connections to the process and to the exhaust. Gas leakage is dangerous because process gas and calibration gas are flammable. Please refer to the leak check instructions in this manual and verify that there is no gas leakage.
	Do not use the product except at the rated pressure, specified connection standards, and rated temperature. Use under other circumstances might cause damage that leads to a serious accident.
	For wiring work in an explosion-proof area, follow the work method stated in the explosion-proof policy.
	Both the process gas and calibration gas (pure methane) are flammable, and if mixed with air and ignited, they may explode. For safety, do the following before beginning to work. Use gas detector to make sure that no flammable gas can be detected in the work area, instrument, or surrounding air. We recommend the continued use of the gas detector during work.

 CAUTION	
	After installation, do not step or stand on this unit. Doing so may damage the device or cause injury.
	Bumping the glass of the display with a tool may cause damage or injury. Be careful.
	Install the device correctly. Incorrect or incomplete installation will cause output errors and violation of regulations.
	This product is quite heavy. Protect your feet with safety shoes when working.
	Do not subject the product to shock or impact.
	The outlet of the device should be connected to ventilation tube with an inner diameter large enough not to be affected by backpressure. It should open to the air in a place not affected by wind, rain or snow. Natural gas and methane are discharged directly from the vent, so the vent should be located where human beings will not be harmed. When cleaning the inside of the tube by blowing back clean inert gas, to protect the device, do not blow gas into the model device.





Wiring Precautions



 WARNING	
	Do not do wiring work with wet hands or while electricity is being supplied to the product. There is a danger of electric shock. When working, keep hands dry or wear gloves, and turn off the power.

 CAUTION	
	When wiring, check the specifications carefully and make sure to wire correctly. Incorrect wiring can cause device damage or malfunction.
	Supply electric power correctly according to the specifications. Supplying power that differs from the specifications can damage the device.
	Use a DC power supply that has overload protection.
	Never open the case cover while the device is ON in a hazardous location.

	Handle the device with care. It may lose its explosion-proof performance due to corrosion.
	Explosion-proof performance is not guaranteed unless the case is LOCKED. Always tighten the case cover completely and lock it.

Maintenance Precautions

 WARNING	
	When removing this device for maintenance, be careful of residual pressure or residual process gas. Leakage of process gas is dangerous.
	When working on the vent, check its direction so that people do not come into contact with vented gas. There is a danger of burns or other physical harm.
	When the device is being used in an explosion-proof area, do not open the cover. Opening the cover may cause an explosion.

 CAUTION	
	This product was kept under carefully controlled conditions until it was shipped. Never try to modify this device. Doing so could damage it.

Precautions for Using Communication Devices

When using a communication device such as a transceiver, cell phone, PHS phone, or pager near this device, observe the precautions below. Otherwise, depending on the transmission frequency, this device may not function properly. Determine beforehand the minimum distance at which the communication device will not affect the operation of this device, and maintain a separation greater than that distance.
Make sure the cover of its transmitter section of this device is closed before using the communication device.

Precautions for Communication

If transmitter output is reduced to 3.2 mA or less because of burnout, etc., communication with a HART communicator may not be possible. Try turning off the power, rebooting, and restarting communication.

Hazardous Area Certifications

Device complies with the types of protection that are based on the standards listed below.

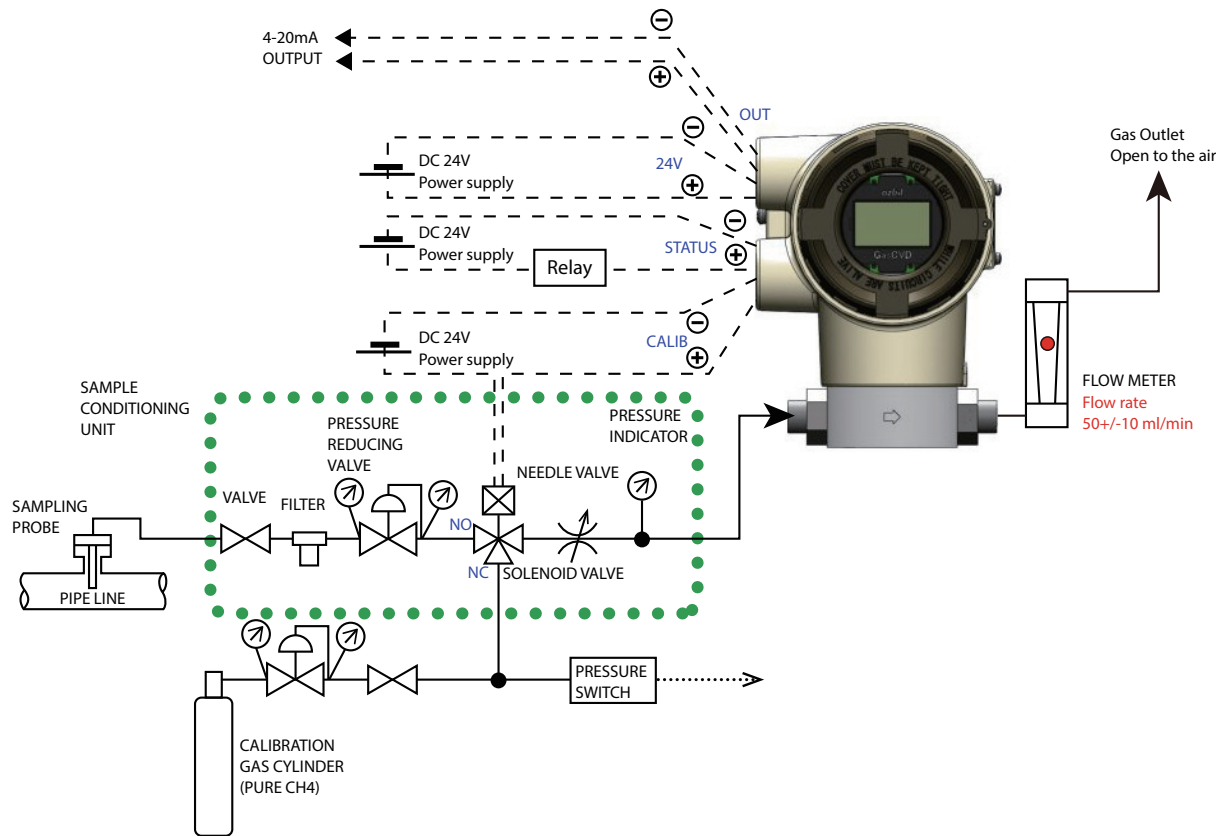

Figure 1. Example of recommended installation

Model number table

CVM400	-												
Process connection	1/8 NPT (F)	1											
	Rc 1/8	3											
Electrical conduit connection	1/2 NPT (F)		1										
	G 1/2		3										
Accuracy	Always "A"			A									
Explosion-proof structure	ATEX Flameproof *9				E								
	IEC flameproof *9				G								
	KCs flameproof *9*13				K								
	TIIS flameproof *13*14				J								
	NEPSI flameproof *9				N								
	Water proof				W								
Communications	HART				H								
Gas type	Natural gas				A								
	OIML R140 CVDD compliant *1*2				F								
	LNG				G								
	LNG13A C3 base gas				H								
	LNG13A				J								
	LNG 13A C4 base gas				K								
	Natural gas(G-gas) *10 *12				L								
	Natural gas(B-gas) *10 *12				M								
	Bio gas *11 *12				N								
	Natural gas(Methane Number) *4				Q								
	LNG(Methane Number) *4				R								
	LNG for ship *5				S								
	Indicator	Without Display				X							
With Display				A									
Paint	Standard finish					X							
	Corrosion-proof finish					B							
Gas calorific value calculation parameters	15 °C/15 °C									1			
	0 °C/0 °C									2			
	25 °C/0 °C									3			
	20 °C/20 °C									4			
	15 °C/0 °C									5			
	25 °C/20 °C									6			
	Unspecified									X			
Output units	SCV MJ/m ³										1		
	WI_Hs MJ/m ³										4		
	ICV MJ/m ³										7		
	WI_Hi MJ/m ³										A		
	SCV MJ/kg *6										D		
	ICV MJ/kg*6										F		
	Methane Number(CEN) *7 *8										M		
	Methane Number(CARB/GRI) *7 *8										N		

X	No
1	Test report
2	Traceability
4	Material

Note) *1: The code 1 "15 °C/15 °C" of the gas calorific value calculation parameter should be selected.

*2: The code 1 " SCV MJ/m³" of the output units should be selected.

*3: The certification sheet for gas cylinder is not included.

*4: Code M or N of Output units should be selected.

*5: Code D or F of Output units should be selected.

*6: Code S of Gas type should be selected.

*7: Code Q or R of Gas type should be selected.

*8: Code X of Gas calorific value calculation parameters should be selected.

*9: Cannot be combined with code 3 of Electrical conduit connection.

*10: Code 1 or 4 of Output units should be selected.

*11: Code 1 of Output units should be selected.

*12: Special model.

*13: Code A of Indicator should be selected.

*14: Code 3 of electrical conduit connection should be selected.

Dimensions

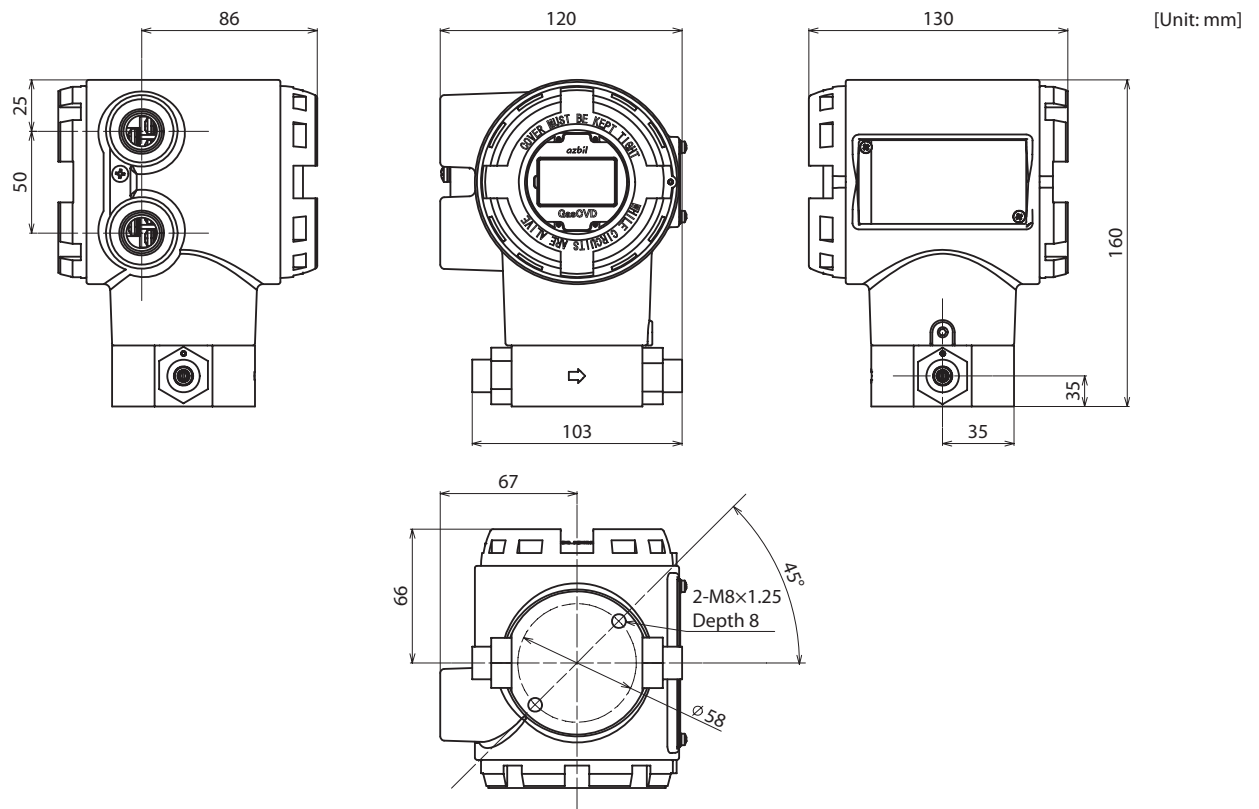

Please read "Terms and Conditions" from the following URL
before ordering and use.
<https://www.azbil.com/products/factory/order.html>

Specifications are subject to change without notice.

The logo for Azbil Corporation, featuring the word "azbil" in a bold, lowercase, sans-serif font.

Azbil Corporation
Advanced Automation Company

1-12-2 Kawana, Fujisawa
Kanagawa 251-8522 Japan
URL: <https://www.azbil.com/>

1st edition: June 2015
11th edition: Sep. 2022

*No part of this publication may be reproduced or duplicated
without the prior written permission of Azbil Corporation.*