

MCF Air Flowmeter User's Manual for Installation and Configuration



Thank you for purchasing the MCF.

This manual contains information for ensuring the correct use of the MCF. It also provides necessary information for installation, maintenance, and troubleshooting.

This manual should be read by those who design and maintain equipment that uses the MCF. Be sure to keep this manual nearby for handy reference.

Azbil Corporation

NOTICE

Be sure that the user receives this manual before the product is used.

Copying or duplicating this user's manual in part or in whole is forbidden. The information and specifications in this manual are subject to change without notice.

Considerable effort has been made to ensure that this manual is free from inaccuracies and omissions. If you should find an error or omission, please contact the azbil Group.

In no event is Azbil Corporation liable to anyone for any indirect, special or consequential damages as a result of using this product.

© 2008-2023 Azbil Corporation All Rights Reserved.

The μ F™, Micro Flow and μ F sensor are a trademark of Azbil Corporation in Japan.

Conventions Used in This Manual

- To prevent injury to the operator and others, and to prevent property damage, the following types of safety precautions are indicated:



Warnings are indicated when mishandling this product might result in death or serious injury.



Cautions are indicated when mishandling this product might result in minor injury to the user, or only physical damage to the product.

- In describing the product, this manual uses the icons and conventions listed below.



Use caution when handling the product.



The indicated action is prohibited.



Be sure to follow the indicated instructions.

Handling Precautions:

Handling Precautions indicate items that the user should pay attention to when handling the MCF.



Note:

Notes indicate information that might benefit the user.



:

This indicates the item or page that the user is requested to refer to.

(1), (2), (3):

Numbers within parentheses indicate steps in a sequence or parts of an explanation.

>>:

Indicates the result of an operation, details displayed on the personal computer or other devices, or the state of the device after operation.

Safety Precautions

WARNING



Never allow gases that are within explosive limits to pass through this device. Doing so could result in an explosion.



Do not use this device for oxygen gas. Doing so could result in a serious accident.

CAUTION



Be sure to use this device within the flow rate range stated in the specifications. To prevent excessive flow, use a suitable means to control the supply pressure or use a throttle valve or the like to control the flow rate.



If damage could result from the abnormal functioning of this device, include appropriate redundancy in the system design.



If there is a risk of a power surge caused by lightning, use Azbil Corporation's SurgeNon to prevent possible fire or equipment failure.



When carrying the flowmeter or connecting it to the pipe, do not hold it by the measurement module. Doing so could cause damage, or the device could drop, causing an injury.



To avoid damaging this device, do not use it outside of the operating pressure range. Also, do not subject it to a pressure above its pressure resistance.



When maintaining or replacing the measurement module, release the internal pressure of this device before removing the measurement module.

The Role of This Manual

Three manuals are available for the MCF. Read appropriate manuals according to your requirements. If you do not have a required manual, contact the azbil Group or your dealer. Additionally, you can download necessary manuals from <http://www.azbil.com>.

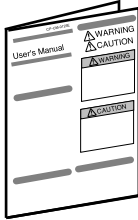

MCF Air Flowmeter User's Manual for Installation

Manual No. CP-UM-5498JE

This manual is supplied with the device. Personnel in charge of design and/or manufacture of a system using this device must thoroughly read this manual. This manual describes the safety precautions, installation, wiring, list of parameters, and primary specifications.

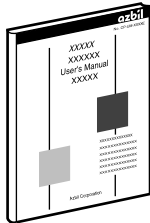

MCF Air Flowmeter User's Manual for Installation and Configuration

Manual No. CP-SP-1276E

This manual describes the hardware and all functions of this device. Personnel in charge of design, manufacture, operation, and/or maintenance of a system using this device must thoroughly read this manual. It describes installation, wiring, functions and settings, operating procedures, troubleshooting, and specifications.

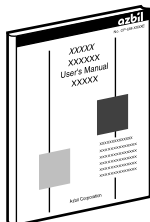

MCF Air Flowmeter User's Manual for Communication Functions

Manual No. CP-SP-1300E

Those using the "communication functions" of the MCF series should read this manual.

This manual describes an outline of communications, wiring, communication procedures, a list of MCF series communication data, how to remedy trouble, and communication specifications.

Contents

Conventions Used in This Manual	
Safety Precautions	
The Role of This Manual	

Chapter 1. OVERVIEW

■ Summary.....	1
■ Features	1
■ Model selection guide.....	2
■ Optional parts (sold separately).....	2

Chapter 2. PART NAMES AND FUNCTIONS

■ Parts name and functions.....	3
---------------------------------	---

Chapter 3. MOUNTING AND WIRING

■ Installation location.....	4
■ Excessive flow rate	4
■ Piping.....	5
■ Wiring.....	13

Chapter 4. FUNCTIONS

■ Display.....	15
■ Flow rate display unit.....	15
■ Output (4 to 20 mA output models MCF_____D01_____ only)	16
■ Integration function.....	16
■ Event output (4 to 20 mA output models MCF_____D01_____ only) ...	16
■ Event function (RS-485 communications models MCF_____D10_____ only) ...	17
■ Operating pressure selection.....	18
■ Reference temperature selection	18
■ Low flow cutoff	18
■ Self-diagnosis function	18
■ Data storage.....	18
■ Integration options for backflow.....	19
■ Reverse flow measurement.....	20
■ Expansion of flow rate range	20

Chapter 5. SETTING AND OPERATION

■ State transitions	21
■ Function setup	22
■ Parameter setup	25
■ Device information display	29
■ Other indications	30
■ Resetting integrated data	30
■ Maintenance mode	30

Chapter 6. MAINTENANCE AND TROUBLESHOOTING

■ Maintenance	33
■ Troubleshooting	35

Chapter 7. SPECIFICATIONS

■ General specifications	37
■ Environmental conditions	39
■ External dimensions	40
■ Pressure loss	43

Chapter 1. OVERVIEW

■ Summary

The MCF air flowmeter uses a μ F (Micro Flow) sensor in its sensing unit. The μ F sensor is a thermal flow speed sensor which uses proprietary technology. Integrating this ultra-miniature flow speed sensor with high-grade channel design technology has achieved high accuracy and wide rangeability.

■ Features

- Incorporates a thermal flow speed Micro Flow sensor. With the silicon micro-machining and the thin-film forming technologies, the μ F sensor is a mere 1.7 mm square and 0.5 mm thick, and features high sensitivity and fast response.
- Because this device is a mass flowmeter, its readings are not affected by temperature or pressure.
- The MCF with 4 to 20 mA output provides instantaneous flow rate and integrated flow display, and provides analog current output for instantaneous flow rate, as well as event outputs for integration pulse or alarms.
The MCF with RS-485 communications provides instantaneous flow rate, integrated flow display and RS-485 communications function.
- A bypass structure using orifices affords a wider flow rate range per pipe size than previous mass flowmeters, with low pressure loss.
- Dust tightness is improved by the bypass structure and flow path design.
- Self-diagnostic function for easy handling of malfunctions.
- Measurement module is detachable, so maintenance can be done without removing the flowmeter.
- Measurement module can be swapped between the MCF0250, MCF0400 and MCF0500.
- Display unit can be rotated, for viewing from the desired direction.

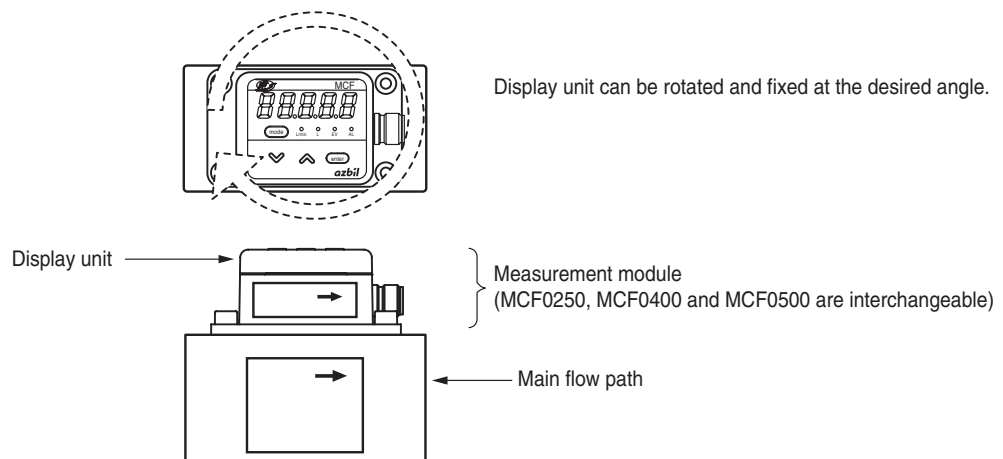

■ Model selection guide

MCF										MCF Air flowmeter
	0080									8A (1/4B), 200L/min, full scale
	0150									15A (1/2B), 500L/min, full scale
	0151									15A (1/2B), 1000L/min, full scale
	0250									25A (1B), 3000L/min, full scale
	0400									40A (1 1/2B), 3000L/min, full scale
	0500									50A (2B), 12000L/min, full scale
		A								Body: aluminum alloy Rubber: HNBR
		F								Body: aluminum alloy (Degreasing treatment *1) Rubber: FKM
			R							Rc thread
			G							G thread
				N						Air/nitrogen
					D01					24 Vdc power, 4 to 20 mA output, one event output
					D10					24 Vdc power, RS-485
						0				None
							0			None
								0		None
									D	Inspection certificated provided
									Y	With traceability certification
										0
										Product version

*1.  page 38

■ Optional parts (sold separately)

Name	Model number	Cable length	Cable properties	Lead color
Cable with connector exclusive for MCF series	PA5-4ISX2MK-E	2m	Oil resistant, bend-tolerant	1: Brown 2: White 3: Blue 4: Black
	PA5-4ISX3MK-E	3m	Flame-resistant cable	
PA5-4ISX5MK-E	5m	UL2464 EN-compliant		
PA5-4ISX2HK-E	2m	Oil resistant		
Extension cable with connector	PA5-4ISX3HK-E	3m	Flame-resistant cable	
	PA5-4ISX5HK-E	5m	UL2464 EN-compliant	
	PA5-4ISB2MK-E	2m	Oil resistant, bend-tolerant	
	PA5-4ISB3MK-E	3m	Flame-resistant cable	
	PA5-4ISB5MK-E	5m	UL2464 EN-compliant	
	PA5-4ISB2HK-E	2m	Oil resistant, Flame-resistant cable	
	PA5-4ISB3HK-E	3m	UL2464	
	PA5-4ISB5HK-E	5m	UL2464 EN-compliant	

Name	Model number	Description
Mounting bracket	81446721-001	For MCF0080/0150/0151/0250
Measurement module	81447192-201	For MCF____A_ND01____
	81447192-221	For MCF____A_ND10____
	81447192-401	For MCF____F_ND01____
	81447192-421	For MCF____F_ND10____

Chapter 2. PART NAMES AND FUNCTIONS

■ Parts name and functions

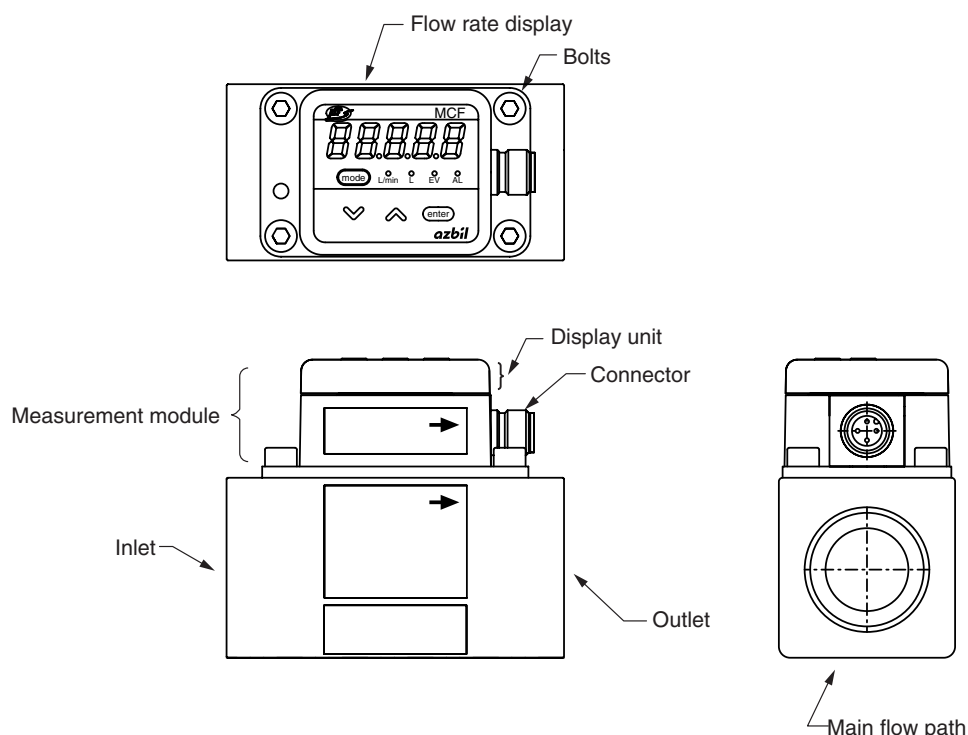

Flow rate display: This 7-segment LED indicates instantaneous flow rate or integrated flow amount. For the integrated flow, the first 4 digits and last 5 digits are displayed separately. The 7-segment display also indicates settings in setting mode and alarm codes when an alarm occurs.

LED lamp:

- [L/min] Lights up while instantaneous flow rate is indicated.
- [L] Lights up while integrated flow is indicated.
- [EV] Synchronized with event output
- [AL] Lights up when an alarm occurs

Keys:

- [mode] Changes the display or switches to setting mode, etc.
- [^] [v] Increases/decreases the value of a setting, changes the display mode, etc.
- [enter] Used to finalize function settings and parameter settings

Main flow path: Connects to pipes. Inlet and outlet are marked.

Measurement module: Removable for maintenance. Can be changed with a new one for the MCF0250, MCF0400 and MCF0500.



Display unit: Can be rotated in a plane parallel to the flow path. Rotates 180° clockwise and 90° counterclockwise, for viewing from any direction.

Connector: Provides the power and signal connections.



Bolts: Fasten the measurement module in the main flow path.

Chapter 3. MOUNTING AND WIRING

WARNING

-  Never allow gases that are within explosive limits to pass through this device. Doing so could result in an explosion.
-  Do not use this device for oxygen gas. Doing so could result in a serious accident.

CAUTION

-  Be sure to use this device within the flow rate range stated in the specifications. To prevent excessive flow, use a suitable means to control the supply pressure or use a throttle valve or the like to control the flow rate.
-  If damage could result from the abnormal functioning of this device, include appropriate redundancy in the system design.
-  If there is a risk of a power surge caused by lightning, use Azbil Corporation's SurgeNon to prevent possible fire or equipment failure.

■ Installation location

Avoid mounting this device in places characterized by any of the following:

- Temperature below -10 °C or above 60 °C
- Humidity exceeding 90 % RH
- Sudden changes in temperature, or condensation
- Corrosive or flammable gases
- Heavy concentration of conductive substances (e.g. dust, salt or iron dust), water droplets, oil mist or organic solvents
- Vibration or shock
- Direct sunlight
- Splashing by water or rain
- Splashing by fluids (e.g. oil, chemicals)
- Constant, heavy splashing by water or dust
- Strong magnetic or electrical fields

■ Excessive flow rate

If the flow rate exceeds the maximum display range, alarm code **FL40** is displayed alternately with the flow rate. Be sure to use the device within the flow rate range stated in the specifications.

■ Piping

● MCF_____R pipe installation cautions

- The MCF is a precision instrument. Do not drop it nor subject it to shock.
- Install so that the direction of gas flow matches the arrow on the side of the MCF.
- Do not apply force to the measurement module during installation.
- When attaching the MCF to the pipe, fix the MCF in place and rotate the pipe to the recommended tightening torque.

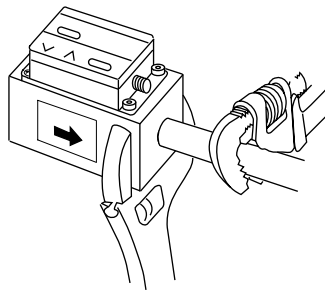

Model number	Pipe size	Recommended tightening torque [N·m]
MCF0080	1/4 inch	12 to 14
MCF0150	1/2 inch	31 to 33
MCF0151	1/2 inch	31 to 33
MCF0250	1 inch	36 to 38
MCF0400	1 1/2 inch	59 to 61
MCF0500	2 inch	74 to 76

- Do not allow foreign matter to enter the MCF. If rust, water droplets, oil mist or dust from the pipe enters the device, measurement, control error, or damage may occur. Before installation, be sure to flush the upstream and downstream piping thoroughly to remove welding fume particulate and dust.
- Coat with an appropriate amount of sealant, but do not coat the top two threads. Doing so might cause measurement error or damage.
- When connecting a piping element such as a pipe with a different diameter, a regulator, a filter, or a valve on the upstream side, use the recommended straight pipe section. Failure to do so could cause a measuring error.
 - ☞ “Accuracy and straight pipe length” (page 9)
- If a reducer or tube fitting is connected without a straight pipe section, the display might indicate a negative flow rate even though air is flowing in the positive direction.

“Straight pipe section” refers to a straight pipe with the same diameter as the MCF port. The following types of pipe are suitable: *Carbon Steel Pipes for Ordinary Piping* (JIS G3452), ANSI schedule 40 or less; *Carbon Steel Pipes for Pressure Service* (JIS G3454), or ANSI schedule 40 or less; *Stainless Steel Pipes* (JIS G3459).
- Although there are no restrictions of mounting direction, if the MCF is mounted on a horizontal pipe and the display faces to the side, a measuring error can be caused by the mounting direction.
 - ☞ “Mounting direction” (page 7)

Also, if the unit is mounted on a horizontal pipe with the display facing downward, foreign matter (rust, water droplets, oil mist, dust) in the pipes might accumulate in the sensor, causing measuring error or damage.
- Do not install this device near the outlet of a compressor or bellows pipe, or in a location where the regulator and the check valve cause a hunting phenomenon. Doing so could cause measurement error.

● **MCF _____ G pipe installation cautions**

- The MCF is a precision instrument. Do not drop it nor subject it to shock.
- Install so that the direction of gas flow matches the arrow on the side of the MCF.
- Do not apply force to the measurement module during installation.
- Do not allow foreign matter to enter the MCF. If rust, water droplets, oil mist or dust from the pipe enters the device, measurement error, control error, or damage may occur. Before installation, be sure to flush upstream and downstream piping thoroughly to remove foreign matter.
- Be sure to use the gasket between the pipe and the MCF.
- When connecting a piping element such as a pipe with a different diameter, a regulator, a filter, or a valve on the upstream side, use the recommended straight pipe section. Failure to do so could cause a measuring error.
- If a reducer or tube fitting is connected without a straight pipe section, the display might indicate a negative flow rate even though air is flowing in the positive direction.

“Straight pipe section” refers to a straight pipe with the same diameter as the MCF port. The following types of pipe are suitable: Carbon Steel Pipes for Ordinary Piping (JIS G3452), ANSI schedule 40 or less; Carbon Steel Pipes for Pressure Service (JIS G3454), or ANSI schedule 40 or less; Stainless Steel Pipes (JIS G3459).

- Although there are no restrictions of mounting direction, if the MCF is mounted on a horizontal pipe and the display faces to the side, a measuring error can be caused by the mounting direction.
Also, if the unit is mounted on a horizontal pipe with the display facing downward, foreign matter (rust, water droplets, oil mist, dust) in the pipes might accumulate in the sensor, causing measuring error or damage.
- Do not install this device near the outlet of a compressor or bellows pipe, or in a location where the regulator or the check valve causes hunting. Doing so could cause measurement error.

● Mounting direction

Normally the MCF is mounted on a horizontal pipe with the display unit facing upward. Though the mounting position is unrestricted, measurement error might be caused by the display direction.

- Normal position on horizontal pipe with display facing upward (Position 1)

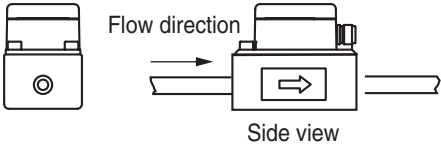

- Horizontal pipe with display rotated to the right as seen from air inlet (Position 2)

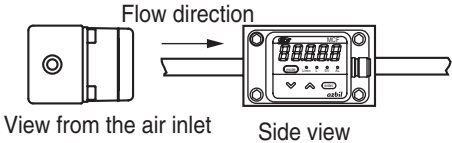

- Horizontal pipe with display rotated to the left as seen from air inlet (Position 3)

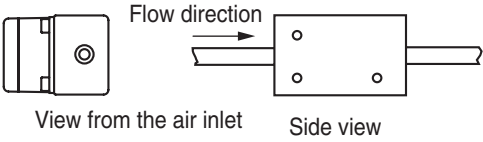

- Horizontal pipe with display facing downward (Position 4)

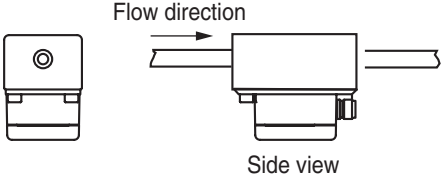

- Vertical pipe (Position 5)

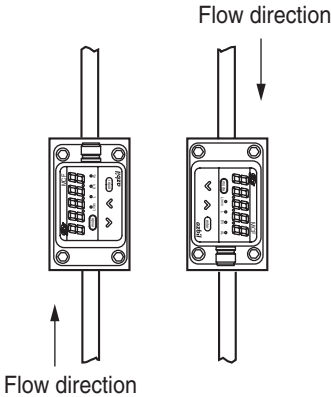

- **Horizontal pipe with the display facing right as seen from the air inlet (Position 2)**

Operating pressure range	Flow rate range	Instantaneous flow rate deviation
0 to 1 MPa	5 to 100 % of full scale flow rate	0.5 %FS per 0.1MPa ±1 digit or less
-0.07 to 0 MPa	5 to 100 % of full scale flow rate	0.5 %FS per 0.01MPa ±1 digit or less

Example: When the MCF is mounted on horizontal piping with the display unit facing to the right as seen from the air inlet, the instantaneous flow rate deviation is 1.5 %FS ±1 digit or less as compared with the accuracy in the normal position at 0.3MPa.

$$0.5 \%FS / 0.1 \text{ MPa} \times 0.3 \text{ MPa} = 1.5 \%FS$$

Note:  Maintenance mode settings table (page 31, for error correction)

- **Horizontal pipe with the display facing left as seen from the air inlet (Position 3)**

Operating pressure range	Flow rate range	Instantaneous flow rate deviation
0 to 1 MPa	5 to 100 % of full scale flow rate	-0.5 %FS per 0.1MPa ±1 digit or less
-0.07 to 0 MPa	5 to 100 % of full scale flow rate	-0.5 %FS per 0.01MPa ±1 digit or less

Example: When the MCF is mounted a horizontal piping and the display unit looks to the left from the air inlet, the instantaneous flow rate deviation is -1.5 %FS ±1 digit or less as compared with the accuracy in the normal position at 0.3MPa.

$$-0.5 \%FS / 0.1\text{MPa} \times 0.3 \text{ MPa} = -1.5 \%FS$$

Note:  Maintenance mode settings table (page 31, for error correction)

Handling Precautions

- When the MCF is mounted on horizontal piping with the display facing to the right or left side as seen from the air inlet, we recommend setting the low flow cutoff at 5 (±5 % of the full scale flow rate) or less. If no low flow cutoff is set, the integrated value might accumulate even without an air flow.

- **Horizontal pipe with the display facing downward and vertical pipe (Positions 4, 5)**

The characteristics of the MCF do not change as compared with the normal position. However, if the MCF is mounted on horizontal piping with the display unit downward, accuracy might decrease due to accumulated moisture, mist or dust from the air.

- **Filter**

- If there is a possibility of foreign matter entering the device, install a filter, strainer or mist trap upstream capable of eliminating foreign matter larger than 1 μm in diameter.
- If an oil mist can be expected frequently, be sure to install a mist separator.
Model number: MFF25S / MFF25L
 Specifications sheet No. CP-SS-1824E
- Inspect and replace the filter periodically.

● Accuracy and straight pipe length

• Connection with different size piping, valve or filter

Install straight pipes as needed with the lengths given in the table below.

If a device that is not listed in the table is installed either upstream or downstream, contact the azbil Group for the length of the straight pipe section.

If reverse flow is also expected, it is necessary to have the same length of straight pipe downstream as upstream.

Pipe or connected device	Location in relation to the MCF	Straight pipe section for this device	
		For accuracy within specifications ($\pm 3\%$ FS)	For accuracy within $\pm 5\%$ FS
MFF25S mist separator for MCF0080/0150/0151/0250 (Note 3)	Upstream	10D	(Not required)
MFF25L mist separator for MCF0400/0500 (Note 3)	Upstream	20D	(Not required)
Pipe one size larger in dia. (connected with reducer) (Note 4, 5)	Upstream	5D	(Not required)
MCF0080 3/8 inch→1/4 inch MCF0150/0151 3/4 inch→1/2 inch MCF0250 1 1/4 inch→1 inch MCF0400 2 inch→1 1/2 inch	Downstream	(Not required)	(Not required)
Pipe one size larger in dia. (connected with reducer) (Note 4, 5)	Upstream	10D	5D
MCF0500 2 1/2 inch→2 inch	Downstream	5D	5D
Pipe one size smaller in dia. (connected with enlarging pipe) (Note 4, 6)	Upstream	20D	5D
MCF0080 1/8 inch→1/4 inch MCF0150/0151 3/8 inch→1/2 inch MCF0250 3/4 inch→1 inch MCF0400 1 1/4 inch→1 1/2 inch	Downstream	(Not required)	(Not required)
Pipe more than one size smaller in dia. (connected with enlarging pipe) (Note 4, 6)	Upstream	25D	10D
MCF0500 1 1/2 inch→2 inch	Downstream	5D	5D
Single elbow (Note 7)	Upstream	10D	(Not required)
	Downstream	(Not required)	(Not required)
Double elbow (Note 7)	Upstream	10D	10D
	Downstream	(Not required)	(Not required)
Ball valve (full-bore type full open) (Note 8)	Upstream	(Not required)	(Not required)
	Downstream	(Not required)	(Not required)
Regulator for MCF0080 (Note 9)	Upstream	200D	(Not required)
	Downstream	10D	(Not required)
Regulator for MCF0150/0151/0250/0400/0500 (Note 9)	Upstream	30D	(Not required)
	Downstream	5D	(Not required)
Air filter	Upstream	25D	(Not required)

Note 1: Do not connect a carbon steel pipe for pressure service (JIS G3454) or stainless steel pipe (JIS G3459) that is larger than schedule 40. Doing so might cause a deterioration of accuracy. (If the pipe schedule number is larger, the inner pipe diameter is smaller, resulting in reduced accuracy.)

Note 2: The approximate size of the connection port (D) is 8 mm for the MCF0080 (1/4 inch), 15 mm for the MCF0150/0151 (1/2 inch), 25 mm for the MCF0250 (1 inch), 40 mm for the MCF0400 (1 1/2 inch), and 50 mm for the MCF0500 (2 inch).

Note 3: The straight pipe section lengths given in the right-hand columns above are for connection of a filter the same size (internal diameter) as the MCF.

Note 4: MCF models and connecting pipe sizes are shown below.

Model No./Pipe size	1/8 inch	1/4 inch	3/8 inch	1/2 inch	3/4 inch
MCF0080	▲	●	+		
MCF0150/0151			▲	●	+

Model No./Pipe size	3/4 inch	1 inch	1 1/4 inch	1 1/2 inch	2 inch	2 1/2 inch
MCF0250	▲	●	+			
MCF0400			▲	●	+	
MCF0500				▲	●	+

- ▲ Pipe one size smaller than the MCF
- Pipe the same size as the MCF
- + Pipe one size larger than the MCF

Note 5: The figure below shows an example of the MCF0080 connected with a reducer. The accuracy is within the specification range ($\pm 3\%$ FS).

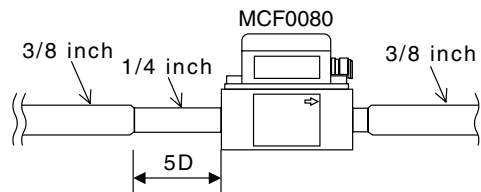

When connecting the MCF to a pipe 1 size larger than the MCF port (for example, the MCF0080 to a 1/2 inch pipe), to determine the straight pipe length, use the section of the table marked "Pipe one size larger in dia. (connected with reducer)."

Note 6: The figure below shows an example of the MCF0150 connected with an enlarging pipe. The accuracy is within the specification range ($\pm 3\%$ FS).

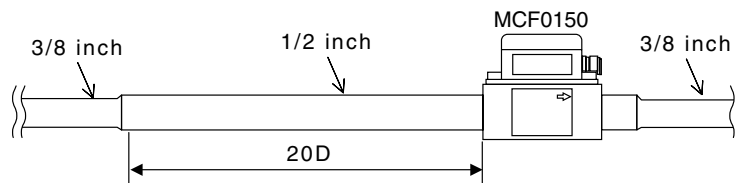

Do not connect a smaller size pipe to the MCF without a straight pipe section. Doing so might cause a reverse flow in the measurement module, even though there is a regular forward flow in the main flow path. Therefore the display might indicate a negative value or an extremely low flow rate compared with the actual rate.

When connecting the MCF to a pipe 1 size smaller than the MFC port (for example, the MFC0150 to a 1/4 inch pipe), to determine the straight pipe length use the section of the table marked "Pipe one size smaller in dia. (connected with reducer)." In addition, on the upstream side add 5D to the straight pipe length.

* The specified length is the straight pipe length when connecting a pipe one size smaller than the MCF.

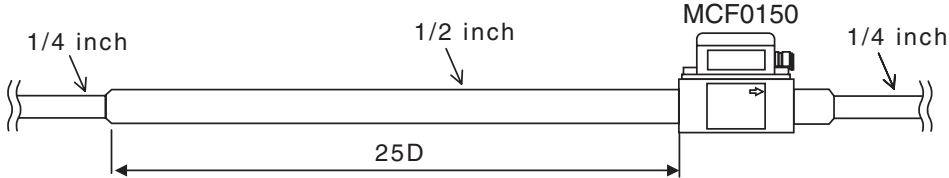

Note 7: The figures below show examples of connection with a single elbow and double elbow.

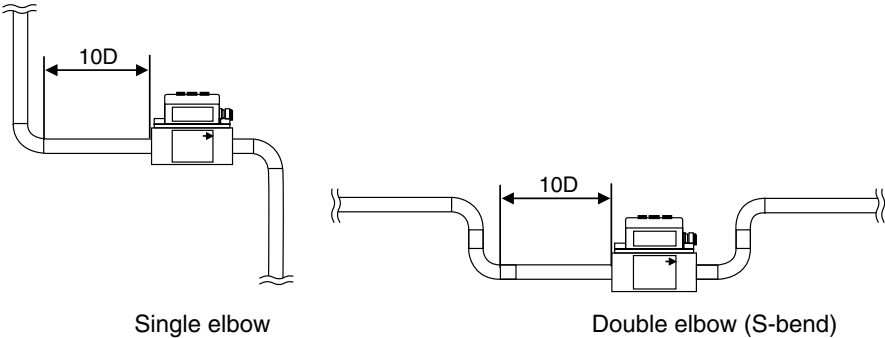

Note 8: This valve does not have an internal throttle. If possible, install a flow regulating valve downstream from the MCF.

Note 9: A regulator should be 200D away from this device. The pipe from the regulator to this device may be consist of an air tube and elbow. However, if the elbow is connected to this device, use the necessary straight pipe section for the elbow.

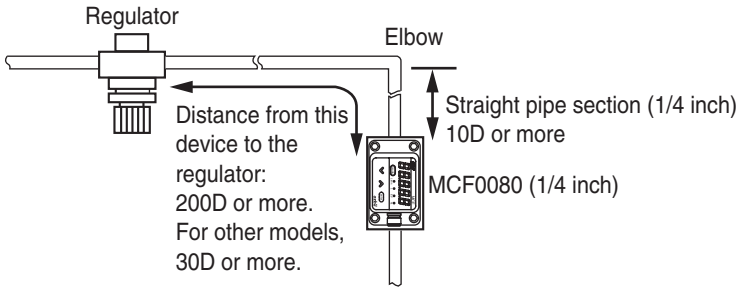

- **Rotation of display unit**

The display unit can be rotated 90° counterclockwise and 180° clockwise from the state of factory shipment (see the figure shown below).

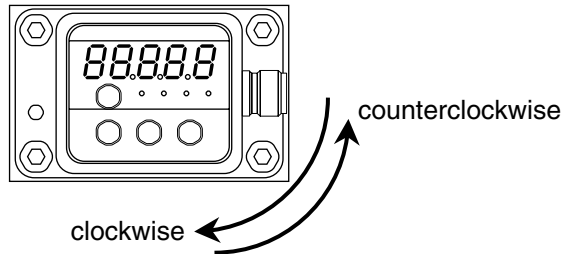

■ **Wiring**

● **Cautions for wiring**

- Supply a power voltage within the specified range.
- Keep the MCF wiring (conduit) away from power wiring or high voltage wires.
- When connecting the connector, push the two parts together, and then tighten the nut by hand to 0.4 to 0.6 N·m. Improper tightening can damage the MCF, or lead to a loss of the IP65 seal, or allow the connector to come loose due to vibration.
- Do not pull the cable forcibly, and do not lift the MCF by the cable (pull-out strength 40 N max., bending force 20 N max.) Do not bend the cable repetitively or put a constant pulling stress on it.
- Do not rotate the cable where it joins the connector (see figure). Doing so might rotate the connector, twisting and damaging the wires inside.

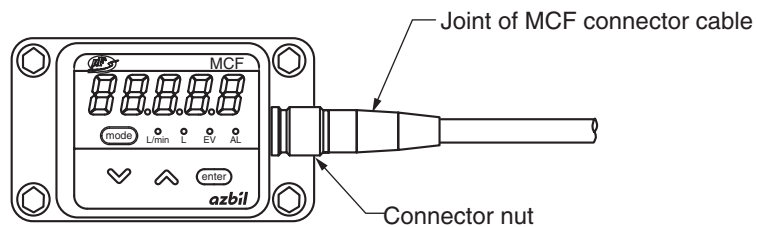

- Before wiring the MCF, be sure to turn the power off.
- Connect a load with a resistance of not more than 300 Ω for the instantaneous flow rate output of the 4 to 20 mA output models (MCF_____D01_____).
- Keep water away from the cable and from the end of the connector while wiring.
- Be sure to check that the wiring is correct before turning the power on. Incorrect wiring could cause damage or malfunction.
- Be sure to check the model No. and wiring before turning the power on. The wiring differs between the 4 to 20 mA output model and the RS-485 communications model.

● **Connector**

Pin number	Signal	MCF_____D01_____ 4 to 20 mA output model	MCF_____D10_____ RS-485 communications model
1	V+	24 Vdc	24 Vdc
2	I+/DB	Instantaneous flow rate output (4 to 20 mA)	RS-485 communications (DB)
3	COM	COM	COM
4	EV/DA	Event output	RS-485 communications (DA)

 **Note**

Wire color and pin number for MCF connector cable

Pin number	Signal	Line color
1	V+	Brown
2	I+/DB	White
3	COM	Blue
4	EV/DA	Black

● Wiring example

• 4 to 20 mA output models (MCF_____D01_____)

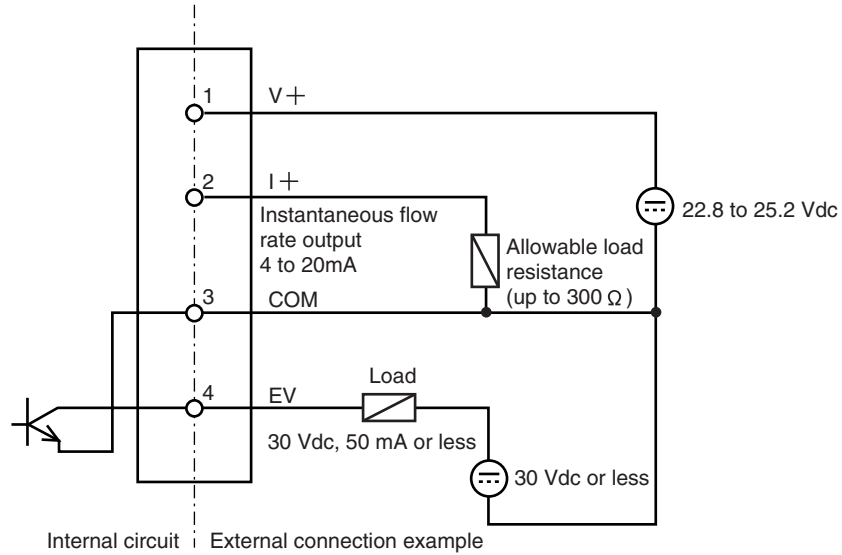

• RS-485 communications models (MCF_____D10_____)

Connect terminating resistors of $150\ \Omega \pm 5\%$, 1/2 W min. at each end of the transmission line. The FG grounding must not be made at the both shielded wire ends but only at one location.

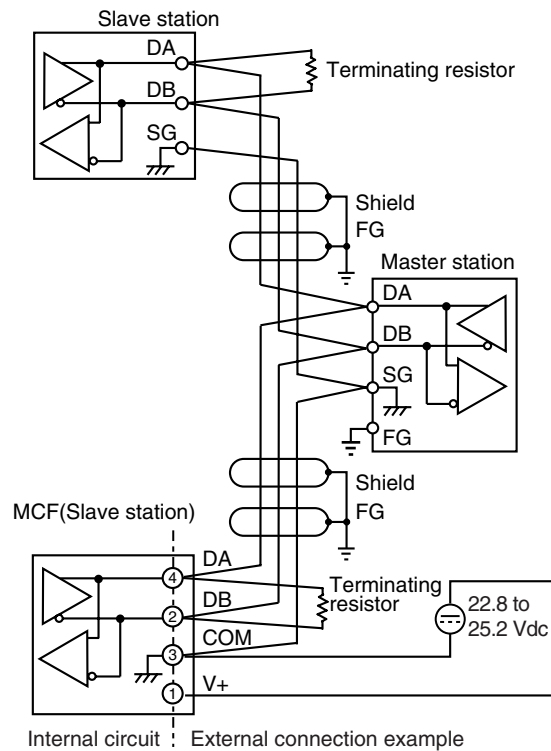

Chapter 4. FUNCTIONS

■ Display

● Instantaneous flow rate display and integrated flow display

The user can display either instantaneous flow rate or integrated flow total on the 7-segment display.

The maximum number of digits displayed for instantaneous flow rate is 5. For the integrated flow, 9 digits are displayed by showing the first 4 digits and the last 5 digits alternately. When the first 4 digits of the integrated flow total are displayed, the leftmost digit of the 7-segment display indicates “H” for count-up integration and “L” for count-down. Without this letter, the display can be recognized as showing the last part of the integrated flow total.

● Peak instantaneous flow rate and lowest instantaneous flow rate

The peak instantaneous flow rate and the lowest instantaneous flow rate during the measurement period can be displayed. The measurement period can be restarted by operating the keys.

● Device information display

The model ID, firmware version, total integrated flow since shipping, and integrated flow before resetting are accessed with this function.

● Status indicator

[L/min]: Lit up during instantaneous flow rate display

[L]: Lit up during integrated flow display

[EV]: Lit up while event output is ON

[AL]: Lit up when an alarm occurs

● No-display mode

The flow rate display unit (7-segment LED, 5 digits) can be set so that it is off in normal use. Even in no-display mode, measurement and outputs continue to operate. In no-display mode, both the L/min and L LED indicators remain on.

■ Flow rate display unit

The units for instantaneous flow rate and integrated flow can be changed.

Example:

C02 setting	00	01	02	03
Flow rate unit	L/min, L	m ³ /h, m ³	m ³ /min, m ³	kg/h, kg
Instantaneous flow rate	200	12.0	0.200	15.5
Integrated flow amount	100000000	100000.000	100000.000	100000.000

The conversion formulas from [L/min] to other flow rate units are as follows:

$$\text{m}^3/\text{h} = \text{L}/\text{min} \times 60 \div 1000$$

$$\text{kg}/\text{h} = \text{L}/\text{min} \times 60 \div 1000 \times 1.293 *$$

* The density of air at 0 °C and 101.325kPa (abs) is set at 1.293.

⚠ Handling Precautions

- If you change the flow rate engineering unit, affix the appropriate unit label (included with the MCF) on top of the current label.

■ **Output (4 to 20 mA output models MCF_____D01_____ only)**

The instantaneous flow rate is output as a 4 to 20 mA analog current. The span flow rate (as displayed) can be changed by the parameter setup. The setting can be changed in increments of 1 digit. By default a flow rate of 0 corresponds to 4 mA and the full-scale flow rate is 20 mA.

■ **Integration function**

Either integration count-up or integration count-down can be selected in the function setup.

- If the integrated value exceeds 999999990, it reverts to 0 and counting continues.
- In the integrated countdown function, the integrated value decreases from a preset value to 0. When it reaches 0, counting stops.
- The (count-up) integrated value is saved to nonvolatile memory every 10 minutes. Therefore, depending on when the power is turned off, up to 10 minutes of integration data may be lost at shutoff. The integrated countdown value is not saved to nonvolatile memory.
- To reset the integrated value, push and hold the [^] key and the [v] key at the same time for 5 seconds or more while the integrated flow (either 4-digit or 5-digit part) is displayed. The integrated count will change to 0. In the case of countdown, the count is reset to the amount set in the integrated flow event setup. When the integrated data is reset, the data before resetting is stored in nonvolatile memory.

■ **Event output (4 to 20 mA output models MCF_____D01_____ only)**

● **Event type**

The event type can be selected from the table below.

Event type	Name	Operation
Instantaneous flow rate switch	Instantaneous flow rate upper limit	Output turns on when the PV exceeds the value set for instantaneous flow rate event 1 in the parameter setup.
	Instantaneous flow rate lower limit	Output turns on when the PV falls below the value set for instantaneous flow rate event 1 in the parameter setup.
	Instantaneous flow rate within range	Output is on when the PV is within the range set for instantaneous flow rate events 1 and 2 in the parameter setup.
Integrated flow switch	Integrated count-up	Output turns on when the integrated flow exceeds the value set for integrated flow event in the parameter setup.
	Integrated countdown	Output turns on when the integrated data becomes 0, decreasing from the value set for integrated flow event in the parameter setup.
Integrated pulse output	Pulse output (a choice of 3 weights* can be assigned to the pulse output)	Outputs a pulse as determined by the event output setting in the function setup. Pulse width is selectable from 50, 250, and 500 ms.
Alarm output	Alarm occurrence	Output turns on when an alarm occurs.

*: Pulse-weight

Model No.	Setup [L/pulse]			Setup [m ³ /pulse, kg/pulse]		
	Minimum unit	10 times the minimum unit	100 times the minimum unit	Minimum unit	10 times the minimum unit	100 times the minimum unit
MCF0080	10	100	1000	0.01	0.1	1
MCF0150	10	100	1000	0.01	0.1	1
MCF0151	10	100	1000	0.01	0.1	1
MCF0250	10	100	1000	0.01	0.1	1
MCF0400	100	1000	10000	0.1	1	10
MCF0500	100	1000	10000	0.1	1	10

● Event hysteresis

If the instantaneous flow rate switch is selected as the event type, a hysteresis (operation gap) can be set. Setting range is 0 to 10 %FS at 1% interval.

● Event on delay

If the instantaneous flow rate switch is selected as the event type, a delay before the event turns ON can be set. Setting range is 0 to 60 seconds at 1 second interval.

● Event standby

If the instantaneous flow rate lower limit event is selected as the event type, the event output can be temporarily disabled until the flow rate has exceeded the lower limit once after the power is turned on.

■ Event function (RS-485 communications models MCF_____D10_____ only)

On models with RS-485 communications, the LED EV indicator lights up when an event is turned on. When the event is turned off, the indicator turns off. There is no output from the terminals. The event state can be checked through the RS-485 communications function.

The event type can be selected from the table below.

Instantaneous flow rate switch	Instantaneous flow rate upper limit	Turns on when the PV exceeds the value set for instantaneous flow rate event 1 in the parameter setup.
	Instantaneous flow rate lower limit	Turns on when the PV falls below the value set for instantaneous flow rate event 1 in the parameter setup.
	Instantaneous flow rate within range	Turns on when the PV is within the range set for instantaneous flow rate events 1 and 2 in the parameter setup.
Integrated flow switch	Integrated count-up	Turns on when the integrated flow exceeds the value set for integrated flow event in the parameter setup.
	Integrated countdown	Turns on when the integrated data becomes 0, decreasing from the value set for integrated flow event in the parameter setup.
Alarm output	Alarm occurrence	Turns on when an alarm occurs.

- For an instantaneous flow rate switch like an event output (4 to 20 mA output models), event hysteresis, event-on delay and event standby can be set.

■ **Operating pressure selection**

By means of the operating pressure setting, the MCF can cancel the effects of pressure characteristics by adjusting the output.

■ **Reference temperature selection**

The reference temperature can be set at 1 °C intervals between 0 to 35 °C. The factory setting is 0 °C.

■ **Low flow cutoff**

The low flow cut can be set at 1 % intervals from 1 to 50 % of the full-scale flow rate. The factory setting is 1 %.

As an example of how the low flow cutoff operates, if it is set at 1 %, the display shows “0” for flow rates from -1 to 1 % of the full-scale flow rate. This setting affects the instantaneous flow rate, integrated flow, and analog output.

■ **Self-diagnosis function**

If there is an abnormal output from the sensor, or a memory error, the MCF’s self-diagnosis function turns on an alarm. For details on alarms, see Alarm codes and remedies in chapter 6, Maintenance and Troubleshooting.

■ **Data storage**

Stored in a nonvolatile memory.

Recording data: Functions setting, parameter setting, integrated value*, instantaneous flow rate peak value*

* Integrated value and instantaneous flow rate value are recorded at every 10 minutes.

■ Integration options for backflow

If there is a reverse flow, the operation of the MCF depends upon the integration option settings, as indicated below.

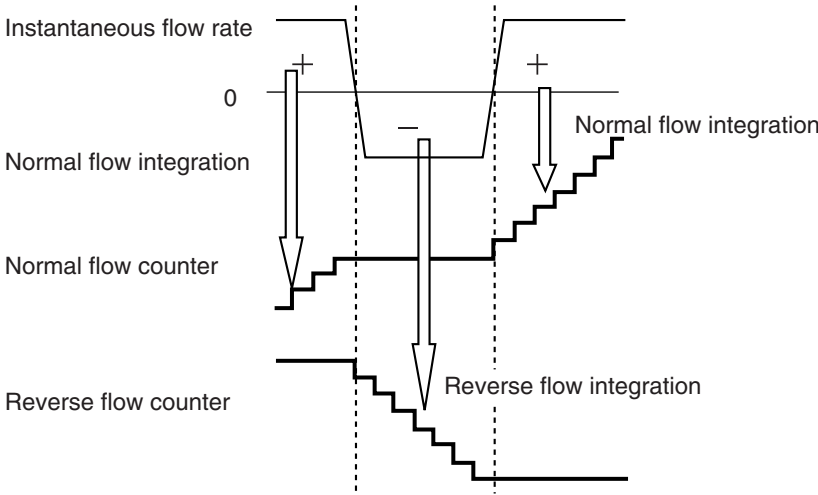
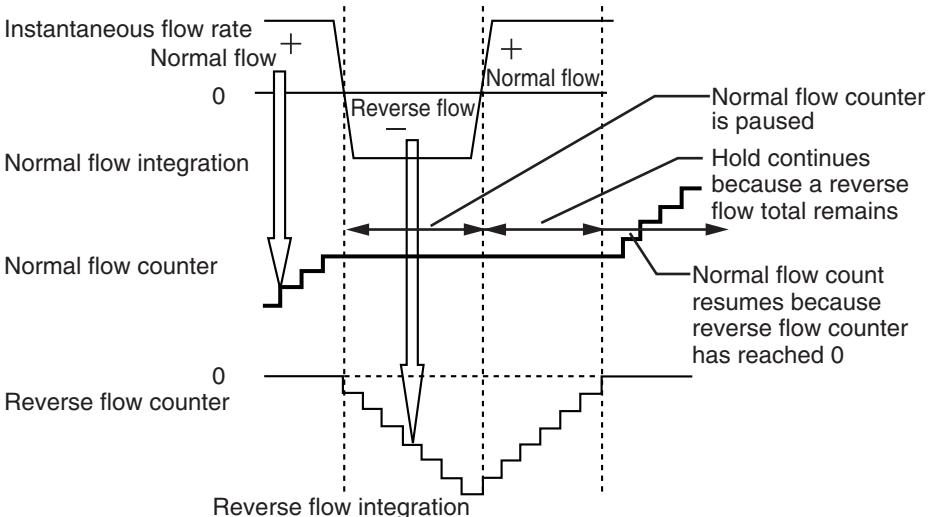
C12 setting	Operation
<p>00: Normal and reverse flows are integrated separately</p>	<p>The MCF integrates normal flow and reverse flow separately.</p>  <p>Instantaneous flow rate</p> <p>Normal flow integration</p> <p>Normal flow counter</p> <p>Reverse flow counter</p> <p>Reverse flow integration</p>
<p>01: Reverse flow is subtracted from the integrated count</p>	<p>When a reverse flow occurs, the MCF resumes integration of the normal flow only after the reverse flow integrated value reaches 0.</p>  <p>Instantaneous flow rate</p> <p>Normal flow integration</p> <p>Normal flow counter</p> <p>Reverse flow counter</p> <p>Reverse flow integration</p> <p>Normal flow counter is paused</p> <p>Hold continues because a reverse flow total remains</p> <p>Normal flow count resumes because reverse flow counter has reached 0</p> <p>When there is a reverse flow, the MCF stops the normal flow counter and starts the reverse flow counter. When normal flow resumes, the MCF subtracts the normal flow from the reverse flow counter until the counter reaches 0. Thereafter the normal flow is added to the normal flow counter.</p>

Note: In each case, the integrated reverse flow rate can be checked on the information display.

■ Reverse flow measurement

The MCF can measure a reverse flow rate up to -30 % of the full-scale flow rate. The nominal display accuracy and repeatability for reverse flow under standard conditions (☞ chapter 7, Specifications) are shown below, as compared with the display accuracy and repeatability for normal flow.

● Accuracy

Model	Flow rate range [L/min] Reverse(upper)/ Normal(lower)	Instantaneous flow rate display accuracy	FS flow rate [L/min]
MCF0080	-60 to -4	±6 % FS	200
	4 to 200	±3 % FS ±1 digit	
MCF0150	-150 to -10	±6 % FS	500
	10 to 500	±3 % FS ±1 digit	
MCF0151	-300 to -20	±6 % FS	1000
	20 to 1000	±3 % FS ±1 digit	
MCF0250	-900 to -60	±6 % FS	3000
	60 to 3000	±3 % FS ±1 digit	
MCF0400	-1800 to -120	±6 % FS	6000
	120 to 6000	±3 % FS ±1 digit	
MCF0500	-3600 to -240	±6 % FS	12000
	240 to 12000	±3 % FS ±1 digit	

● Repeatability

Flow rate range	Instantaneous flow rate repeatability
-30 to 2 % of FS flow rate	Approx. ±2 %FS
2 to 100 % of FS flow rate	±1 %FS ±1 digit

■ Expansion of flow rate range

The MCF can expand the measurable flow rate range up to 200 % of the full-scale flow rate. The nominal display accuracy for the expanded flow under standard conditions (☞ chapter 7, Specifications) is shown below, as compared with display accuracy for normal flow. Repeatability is included in this accuracy figure.

Model	Flow rate range [L/min]	Instantaneous flow rate display accuracy	FS flow rate [L/min]
MCF0080	200 to 400	±10 % RD	200
	4 to 200	±3 %FS ±1 digit	
MCF0150	500 to 1000	±10 % RD	500
	10 to 500	±3 %FS ±1 digit	
MCF0151	1000 to 2000	±10 % RD	1000
	20 to 1000	±3 %FS ±1 digit	
MCF0250	3000 to 6000	±10 % RD	3000
	60 to 3000	±3 %FS ±1 digit	
MCF0400	6000 to 12000	±10 % RD	6000
	120 to 6000	±3 %FS ±1 digit	
MCF0500	12000 to 24000	±10 % RD	12000
	240 to 12000	±3 %FS ±1 digit	

Chapter 5. SETTING AND OPERATION

■ State transitions

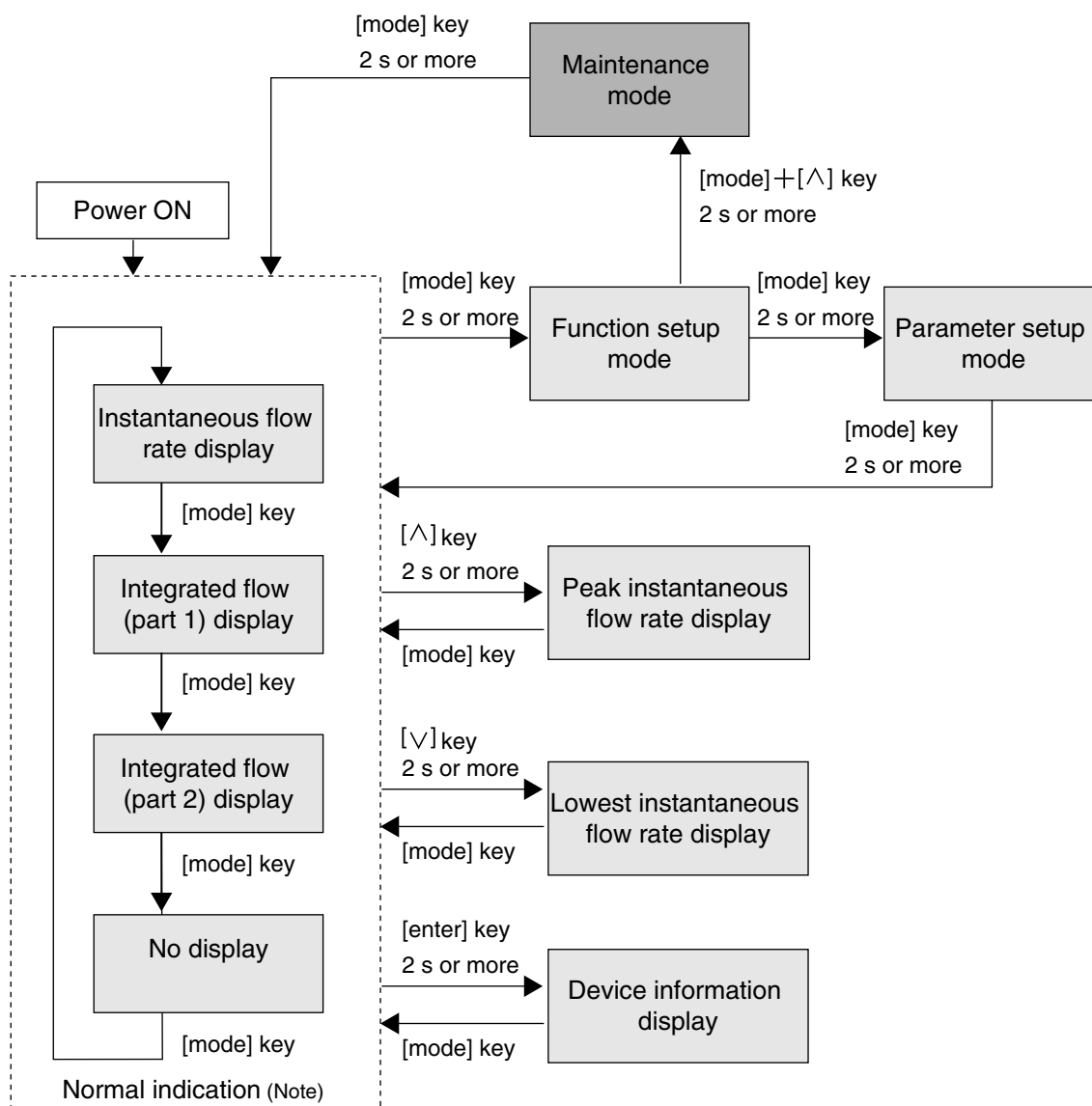

Note: Normal indication means display of the instantaneous flow rate, integrated flow last five digits, integrated flow first four digits, or no-display, depending on the setting of function setup 5.4. If an alarm occurs, the alarm code and normal indication alternate every two seconds. For no-display mode, the alarm lights continuously.

! Handling Precautions

- Do not press the console keys with a sharp object like a mechanical pencil or needle. Doing so will damage the keys.

■ **Function setup**

● **Setup method**

(1) Push and hold the [mode] key for 2 seconds or more in the normal indication mode.

>> The function number is displayed in the first 3 digits and the current setting is displayed in the last 2 digits.

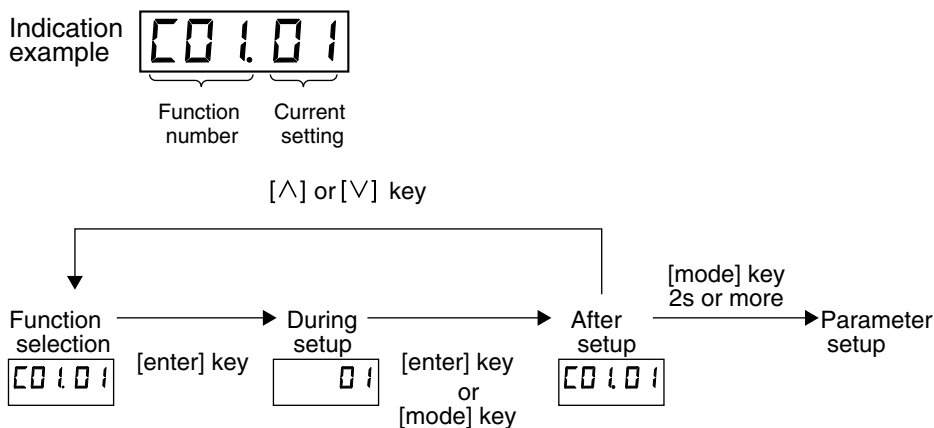

(2) Change the function setup to the desired item by pushing [V] or [^], and then press [enter].

>> The function setup number goes out, and the only the setting (in the last 2 digits) is shown.

(3) Change the setting with the [V] or [^] key, and then press [enter].

>> The changed setting is now entered, and both the function number and the setting are shown.

If the [mode] key is pressed instead of the [enter] key, the MCF exits setup mode without changing the setting.

(4) Repeat steps (2) to (3) if you want to continue setup.

To exit setup mode, press and hold the [mode] key for 2 seconds or more to move to parameter setup, and then again press and hold the [mode] key for 2 seconds or more to return to normal indication mode.

● **Function settings**

Func No.	Name	Settings	Factory setting	Description
001	Key lock setting	00: Unlocked 01: Key locked	00	Even with the keys locked, it is possible to cancel the key lock. If any key is pressed while the keys are locked, "LoL." is displayed.
002	Flow rate units	Unit of instantaneous flow rate and integrated flow (Note 1) 00: L/min, L 01: m ³ /h, m ³ 02: m ³ /min, m ³ 03: kg/h, kg	00	Note: If the units are changed, the integrated flow total remains in the previous units, without automatic conversion. Therefore, after changing the units it is necessary to reset the current integrated flow count. Also, reset No.20 (in Parameter settings). • When this setting is changed, the peak value and the lower value are reset.

Func No.	Name	Settings	Factory setting	Description
003	Event output	00: Not used 01: Instantaneous flow rate upper limit 02: Instantaneous flow rate lower limit 03: Within range for instantaneous flow rate 04: Instantaneous flow rate upper limit (reversed output) (Note 2) 05: Instantaneous flow rate lower limit (reversed output) (Note 2) 06: Within range for instantaneous flow rate (reversed output) (Note 2) 07: Set value reached by integrated flow count-up 08: Set value reached by integrated flow count-up (reversed output) (Note 2) 09: Zero reached by integrated flow countdown 10: Zero reached by integrated flow countdown (reversed output) (Note 2) 11: Integrated pulse output (minimum unit) (Notes 2, 5) 12: Integrated pulse output (minimum unit × 10) (Notes 2, 5) 13: Integrated pulse output (minimum unit × 100) (Notes 2, 5) 14: Alarm 15: Alarm (reversed output) (Note 2)	00	Reversed output is high when the event is OFF and low when the event is ON. To cancel the event output for integrated flow count-up or countdown, reset the count or change the event output type. Since models with RS-485 communications have no event output terminals, the EV LED lamp indicates on event but not event output.
004	Normal indication	00: Instantaneous flow rate indication 01: Last digits of integrated flow 02: First digits of integrated flow 03: No display mode	00	This setting determines what is indicated on the flow rate display after the power is turned on. After exiting normal indication mode, the device enters function setup mode.
007	Event standby	00: Disabled 01: Enabled	00	If 02 or 05 is selected in 003, the event standby will operate until the instantaneous flow rate event setting is exceeded once after power is turned on.
008	Gas type	00: Air, nitrogen (fixed)	00	
010	Operating pressure	00: 0.3 MPa standard 01: 0.1 MPa standard 02: 0.5 MPa standard 03: 0.7 MPa standard	00	If the mounting direction is Position 2 or Position 3, it is possible to reduce the error caused by the mounting direction by adjusting the pressure correction value (in maintenance mode) and the operating pressure. See  "Maintenance mode" (page 30).
011	Reference temperature	00 to 35 °C (every 1 °C)	00	If the setting is changed, the peak value and the lowest value are reset.
012	Integrated flow option	00: Integrate only normal flow 01: Integrate both normal flow and reverse flow (as a minus)	00	
014	Integrated flow pulse width	00: 50 ms 01: 250 ms 02: 500 ms	00	

Func No.	Name	Settings	Factory setting	Description
ƒ 15	Analog alarm output (Note 3)	00: Not used 01: Upper level (variable) 02: Lower level (fixed)	00	For alarms such as sensor error or memory error, the level of current set here is output. For these alarms, flow rate display is "0" while an alarm occurs. If "01: upper level" is selected, the analog alarm output level can be changed in maintenance mode. If "02: lower level" is selected, the analog alarm output level is fixed.
ƒ 30	Device address (Note 4)	00 to 99	00	There is no communication if the address remains set at "00." Set an address that is not already being used by another unit.
ƒ 31	Transmission speed (Note 4)	00: No communication 01: 19200 bps 02: 9600 bps 03: 4800 bps	02	
ƒ 32	Communication conditions (Note 4)	00: 8-bit data, Even parity, Stop bit 1 (RTU) 01: 8-bit data, No parities, Stop bit 2 (RTU) 02: 7-bit data, No parities, Stop bit 1 (ASCII) 03: 7-bit data, No parities, Stop bit 2 (ASCII)	00	For RTU, select "00" or "01" due to 8-bit data processing. For ASCII, select "02" or "03" due to 7-bit data processing. If RTU is selected, 8-bit data processing is always applied even though "02" or "03" is chosen.
ƒ 33	Communications type (Note 4)	00: MODBUS (RTU) 01: MODBUS (ASCII)	00	

Notes: 1. If you change the flow rate engineering unit, affix the appropriate unit label (included with the MCF) on top of the current label.

2. Does not function on RS-485 communications models.
3. Cannot be selected for RS-485 communications models.
4. Can be selected for RS-485 communications models only.
5. Minimum unit

MCF0080/0150/0151/0250: 10 L/pulse (0.01 m³/pulse, 0.01 kg/pulse)

MCF0400/0500: 100 L/pulse (0.1 m³/pulse, 0.1 kg/pulse)

■ Parameter setup

● Setup method

- (1) Push and hold the [mode] key 2 seconds or more in the normal indication mode. The device enters function setup mode. Again press and hold the [mode] key 2 seconds or more. The MCF enters parameter setup mode.

Example of parameter display

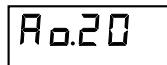

Sample display during setup

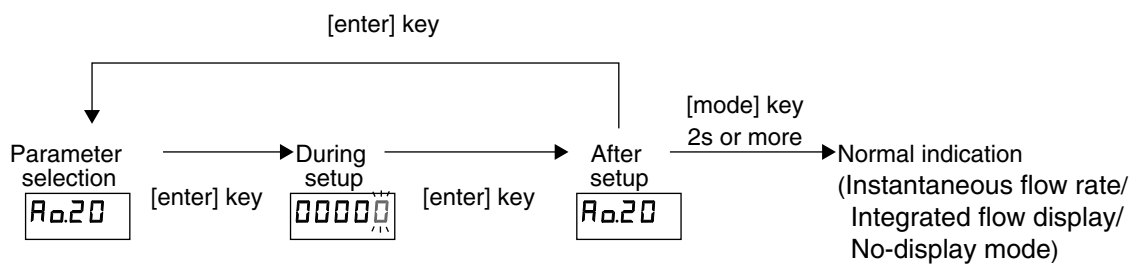

- (2) Move to the desired parameter by pushing [\wedge] or [\vee], and then press [enter].
>> The current setting is indicated with the rightmost digit blinking.
- (3) Push the [mode] key, and the left digit will blink.

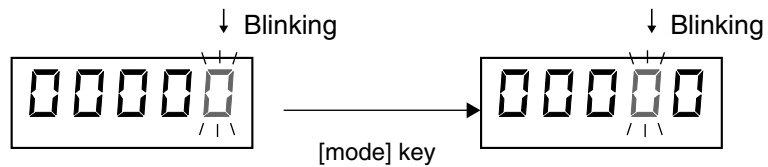

- (4) Use the [\wedge] or [\vee] keys to increase or decrease the numeric value of the blinking digit. Set the desired numerical value for each digit.
- (5) When the desired value is set, press the [enter] key.
>> The setting is changed.
- (6) Repeat steps (2) to (5) if you want to continue setup.
- (7) To exit setup, while the parameter is displayed press and hold the [mode] key 2 seconds or more. The MCF returns to normal indication mode.

● Parameter settings

Item	Name	Setting range	Factory setting	Description
<i>R0.20</i>	Flow rate assignment for 20 mA analog output *1	0 to 400 %FS equiv. *5	Depends on model number	<ul style="list-style-type: none"> No decimal point is displayed on RS-485 communications models. Factory settings are shown below. MCF0080 → 200 MCF0150 → 500 MCF0151 → 1000 MCF0250 → 3000 MCF0400 → 6000 MCF0500 → 12000 The decimal point is not shown in the setting range. Depending on the model number the decimal point is added to the display. If the setting is less than 10 % of the FS flow rate, the desired output may not be possible. Also, if the setting is zero, when there is an alarm the output will be fixed (unchanging). If the flow rate units are changed in function setup <i>002</i>, set <i>R0.20</i> again.
<i>R0.04</i>	Flow rate assignment for 4 mA analog output *1	0 to 400 %FS equiv. *5	0	<ul style="list-style-type: none"> No decimal point is displayed on RS-485 communications models. The decimal point is not shown in the setting range. Depending on the model number the decimal point is added to the display.
<i>E1.SP</i>	Event 1 instantaneous flow rate *2	0 to 400 %FS equiv. *5	0	<ul style="list-style-type: none"> Setup is enabled when function setup <i>003</i> is set to <i>01</i> to <i>05</i>. The decimal point is not shown in the setting range. Depending on the model number the decimal point is added to the display. If the flow rate units are changed in function setup <i>002</i>, set <i>E1.dLY</i> again.
<i>E1.HYS</i>	Hysteresis for event 1 *2	0 to 10 %FS (at 1% interval)	1	
<i>E1.dLY</i>	ON delay for event 1 *3	0 to 60 s (at 1 s interval)	0	
<i>E2.SP</i>	Event 2 instantaneous flow rate *2	0 to 400 %FS equiv. *5	0	<ul style="list-style-type: none"> Setup is enabled when function setup <i>003</i> is set to <i>03</i> or <i>06</i>. The decimal point is not shown in the setting range. Depending on the model number the decimal point is added to the display. If the flow rate units are changed in function setup <i>002</i>, set <i>E2.dLY</i> again.
<i>E2.HYS</i>	Hysteresis for event 2 *2	0 to 10 %FS (at 1% interval)	1	
<i>E2.dLY</i>	ON delay for event 2 *3	0 to 60 s (at 1 s interval)	0	
<i>CF</i>	Output correction factor	0.100 to 2.000	1.000	Settable in increments of 0.001. This setting affects both indication and output. If it is changed, the peak value and lowest value for instantaneous flow rate are cleared.
<i>LFcut</i>	Low flow cutoff	1 to 50 %FS (at 1% interval)	1	This setting applies to both normal flow and reverse flow.
<i>HL</i>	Upper limit for indication	100 to 200 %FS	200	The upper limit for indication can be set at a lower level than the maximum of 200 %FS. If the flow exceeds this upper limit, the display will show only the value specified by this setting.
<i>E1.Lo</i>	Last 5 digits of integrated flow (event setup)	00000 to 99990	0	Settable when function setup <i>003</i> is set to <i>07</i> to <i>10</i> .
<i>E1.Hi</i>	First 4 digits of integrated flow (event setup)	0000 to 9999	0	
<i>Cost</i>	Flow rate cost multiplier *4	1.0 to 100.0	100.0	This setting is used to indicate cost in the device information display.

*1. Analog output scaling

(4 to 20 mA output models MCF_____D01_____ only)

The output current for the instantaneous flow rate is calculated as follows:

$$\text{Output current} = \frac{(\text{Indicated flow rate} - 4 \text{ mA flow rate})}{(20 \text{ mA flow rate} - 4 \text{ mA flow rate})} \times 16 + 4 \text{ mA}$$

Where:

4 mA flow rate assignment: Instantaneous flow rate for 4 mA analog output

20 mA flow assignment: Instantaneous flow rate assignment for 20 mA analog output

- The minimum flow rate output flow is 3.2 mA and the maximum output for normal flow is 20.8 mA.

Depending on the settings for flow rate assignment, a flow rate reaching the upper or lower limit of analog output may be output.

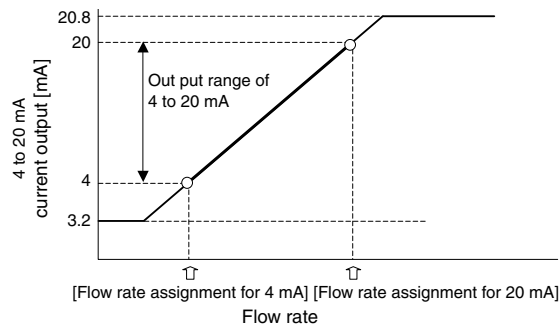

- If 4 mA flow rate assignment $\text{No.04} \geq 20 \text{ mA flow rate assignment No.02}$, the fixed output for alarm occurrence is output.
- If the difference between the flow rate assignments for 20 mA and for 4 mA is smaller than the full-scale flow rate, the resulting lower resolution may make it impossible to get the desired output.

*2.Event output for instantaneous flow rate

Behavior depends on the setting in function setup 003.

- (1) When 003 is set to 01 or 04 (instantaneous flow rate upper limit)

If the flow rate exceeds the instantaneous flow rate upper limit, event output turns on. The point at which event output turns off involves a hysteresis and is calculated as follows:

$$\text{Event OFF point} = \text{instantaneous flow rate upper limit} - \text{hysteresis}$$

Specify the hysteresis as a percentage of the full scale flow rate (%FS).

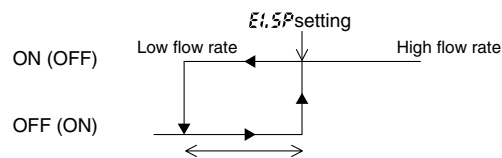

Parenthesis indicate the state for reversed output

E1.5P hysteresis

Note: If the Event OFF point is less than zero, the output turns off at zero.

- (2) When 003 is set to 02 or 05 (instantaneous flow rate lower limit)

If the flow rate falls below the instantaneous flow rate lower limit, event output turns on. The point at which event output turns off involves a hysteresis and is calculated as follows:

$$\text{Event OFF point} = \text{instantaneous flow rate lower limit} + \text{hysteresis}$$

Specify the hysteresis as a percentage of the full scale flow rate (%FS).

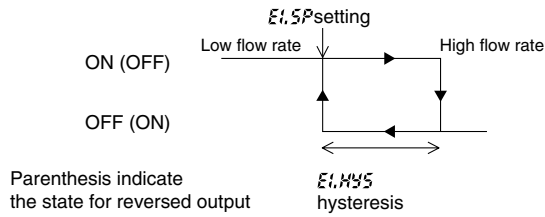

- (3) When $\epsilon 03$ is set to 03 or 05 (within range for instantaneous flow rate)
 When $E1.SP > E2.SP$, the setting for $E1.SP$ is used as the upper limit and the setting for $E2.SP$ is used as the lower limit. When $E1.SP < E2.SP$, the $E1.SP$ setting is the lower limit and $E2.SP$ setting is the upper limit.
 When $E1.SP = E2.SP$, this function does not operate.
 Hysteresis should be set below the lower limit and above the upper limit. Specify hysteresis as a percentage of full scale flow rate (%FS). Different hysteresis can be set for the lower limit and the upper limit.

- $E1.SP$ setting < $E2.SP$ setting

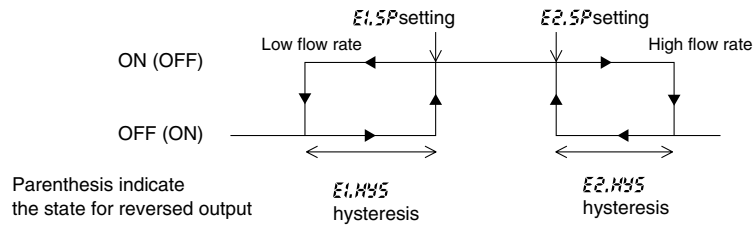

- $E1.SP$ setting > $E2.SP$ setting

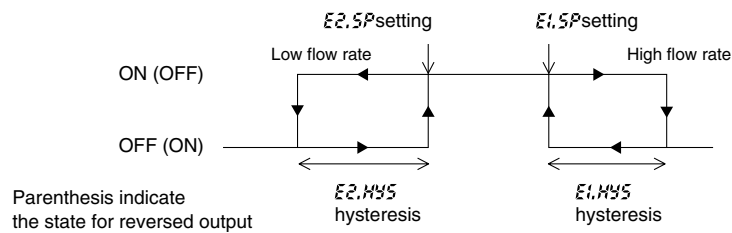

Note: If Event OFF point is less than zero, the output turns off at zero.

*3.Event ON delay

The event ON delay sets a delay before the event output turns on. $E1.DLY$ is for the setup of $E1.SP$ and $E2.DLY$ is for the setup of $E2.SP$.

*4.Flow rate cost calculation

The flow rate cost calculation is related to the setting for flow rate units in function setup $\epsilon 02$.

$\epsilon 02$ setting	Unit of flow rate cost calculation
00: L/min, L	Per 1m ³
01: m ³ /h, m ³	
02: m ³ /min, m ³	
03: kg/h, kg	Per 1kg

*5.Setting range

The setting range depends on the model number and the flow rate indication units. See the table below.

Setting	MCF0080	MCF0150	MCF0151	MCF0250	MCF0400	MCF0500	Notes
00: [L/min]	0 to 800	0 to 2000	0 to 4000	0 to 12000	0 to 24000	0 to 48000	The upper limit of the range corresponds to a flow rate of 400 %FS.
01: [m ³ /h]	0 to 48.0	0 to 120.0	0 to 240.0	0 to 720.0	0 to 1440.0	0 to 2880.0	
02: [m ³ /min]	0 to 0.800	0 to 2.000	0 to 4.000	0 to 12.000	0 to 24.000	0 to 48.000	
03: [kg/h]	0 to 62.1	0 to 155.2	0 to 310.4	0 to 931.0	0 to 1862.0	0 to 3724.0	

If the setting exceeds the upper limit for indication, the instantaneous flow rate output will be equivalent to the upper limit for indication.

Do not set values for Event 1 instantaneous flow rate or Event 2 instantaneous flow rate that exceed the upper limit for indication. The instantaneous flow rate may not reach the set value, so that the event does not operate.

■ Device information display

● Viewing the display

- (1) Press and hold the [enter] key for 2 seconds or more while the instantaneous flow rate or integrated flow is indicated on the display.
 >> The MCF moves to the device information display mode, and indicates the item and the related information alternately.
- (2) To move to the next item, push [/]. To return to the previous item, push [\].
- (3) To quit the device information display mode, push the [mode] key.
 >> The MCF returns to normal indication mode.

● Device information

Item	Name	Description
Id_01	Model number ID	MCF0080 →0 MCF0150 →1 MCF0151 →5 MCF0250 →2 MCF0400 →3 MCF0500 →4
Id_02	Measurement range ID	MCF0080 →2000 (200.0L/min) MCF0150 →5000 (500.0L/min) MCF0151 →10000 (1000.0L/min) MCF0250 →3000 (3000L/min) MCF0400 →6000 (6000L/min) MCF0500 →12000 (12000L/min)
Id_03	Firmware version	
Cost_L	Cost (last digits)	Cost, calculated with the flow rate-cost multiplier.*1
Cost_H	Cost (first digits)	
Integ_L	Reverse integrated flow (last digits)	The integrated flow amount at the time of reverse flow.*2
Integ_H	Reverse integrated flow (first digits)	
Total_L	Total integrated flow (last digits)	Total integrated flow from the time of shipment.
Total_H	Total integrated flow (first digits)	Resetting the integrated flow does not affect this total.
Pre_L	Integrated flow before resetting (last digits)	The integrated flow before it was reset.
Pre_H	Integrated flow before resetting (first digits)	

*1. The cost calculation can be changed by changing the Cost rate (Cost) setting in the parameter setup. In the case of integrated flow countdown, cost is not indicated.

*2. If 0 is selected for Integrated flow option (Integ) in the function setup, the MCF indicates a remaining reverse flow. When the flow returns to normal, this reverse flow is subtracted.

■ Other indications

● Instantaneous flow rate peak value

- (1) Press and hold [\wedge] for 2 seconds or more in the normal indication mode.
 - >> The MCF moves to instantaneous flow rate peak value display mode, and indicates “*FLoHi*” and the peak value alternately.
 - (2) To quit instantaneous flow rate peak value display mode, push the [mode] key.
 - >> The MCF returns to normal indication mode.
- To clear the instantaneous flow rate peak value, press and hold [\wedge] for 5 seconds or more while the peak value is displayed.

● Instantaneous flow rate lowest value

- (1) Press and hold [\vee] for 2 seconds or more in the normal indication mode.
 - >> The MCF moves to instantaneous flow rate lowest value display mode, and indicates “*FLoLo*” and the lowest value alternately.
 - (2) To quit instantaneous flow rate lowest value display mode, push the [mode] key.
 - >> The MCF returns to normal indication mode.
- To clear the instantaneous flow rate lowest value, push and hold [\vee] for 5 seconds or more while the lowest value is displayed.

■ Resetting integrated data

To reset integrated data, press and hold [\wedge] and [\vee] at the same time for 5 seconds or more while the first or last part of the integrated flow amount is indicated on the display.

The integrated flow is reset to zero, unless integrated flow countdown has been selected. In that case, the integrated flow is reset to the amount set in the integrated flow event setup (*ELHi* and *ELLo*).

■ Maintenance mode

The MCF has a special maintenance mode for transferring adjusted values before swapping the measurement module, adjusting the output circuit, etc.

● Changing the Maintenance mode settings

- (1) Press and hold the [mode] key for 2 seconds or more in the normal indication mode. Then press and hold the [mode] key and [\wedge] key at the same time for 2 seconds.
- (2) Move to the desired setup item with the [\vee] or [\wedge] key, and then press [enter].
 - >> The current setting is shown with the rightmost digit blinking.
- (3) If the [mode] key is pressed, the left digit blinks.

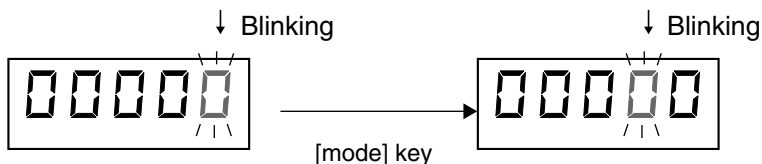

- (4) Press [\wedge] or [\vee] to increase or decrease the numeric value of the blinking digit. Set the desired numerical value for each digit.
- (5) Press the [enter] key.
- (6) Repeat the steps (2) to (5) if you want to continue setup.
- (7) To exit setup, press and hold the [mode] key 2 for seconds or more while the setup item is displayed. The MCF returns to normal indication mode.

● Maintenance mode settings

Item	Name	Setting range setting	Factory	Description
<i>FLt</i>	Calculation filter	1 to 16	8	
<i>CYCLE</i>	Measurement cycle	5 to 100	5	[X10msec]
<i>b.out</i>	Fixed output at alarm occurrence (upper side)	0 to 120%	110	At 1 % intervals Not available for RS-485 communications models
<i>PSCF1</i>	Pressure correction adjustment* ¹	0 to 2.000	0.998	If <i>01</i> is selected for pressure correction in <i>CI0</i>
<i>PSCF2</i>	Pressure correction adjustment* ¹	0 to 2.000	1.002	If <i>02</i> is selected for pressure correction in <i>CI0</i>
<i>PSCF3</i>	Pressure correction adjustment* ¹	0 to 2.000	1.004	If <i>03</i> is selected for pressure correction in <i>CI0</i>
<i>oP.0</i>	Flow path identifier 0* ²	0 to 32768	*****	Can be set for a spare measurement module.
<i>oP.1</i>	Flow path identifier 1* ²	0 to 32768	*****	Registers the inherent flow characteristics of the main flow path. Not available on the MCF0080, MCF0150 and MCF0151.
<i>oP.2</i>	Flow path identifier 2* ²	0 to 32768	*****	
<i>SYSD1</i>	Model number* ²	2=MCF0250 3=MCF0400 4=MCF0500	**	Can be set for a spare measurement module. An incorrect model number will result in wrong measurement. Not available on the MCF0080, MCF0150 and MCF0151.
<i>PCode</i>	Reserved	***	0	Special options

*1: Pressure correction adjustment

If the MCF is mounted in Position 2 or 3 (on horizontal pipe with the display facing right/left as seen from the air inlet), measuring error might occur, depending on the operating pressure. However, this error can be reduced by making this adjustment to the operating pressure.  Page 7 (for measuring error due to mounting direction)

Mounting direction and operating pressure		Settings	
Direction of display	Operating pressure	<i>CI0</i> setting	Maintenance mode setting
Horizontal pipe with display facing right as seen from the air inlet (Position 2)	0.3MPa	Change to 01	Change <i>PSCF1</i> to 0.997
	0.1MPa	01	Change <i>PSCF1</i> to 0.997
	0.5MPa	02	Change <i>PSCF2</i> to 0.997
	0.7MPa	03	Change <i>PSCF3</i> to 0.997
Horizontal pipe with display facing left as seen from the air inlet (Position 3)	0.3MPa	Change to 01	Change <i>PSCF1</i> to 1.003
	0.1MPa	01	Change <i>PSCF1</i> to 0.999
	0.5MPa	02	Change <i>PSCF2</i> to 1.007
	0.7MPa	03	Change <i>PSCF3</i> to 1.011

Note: Pressure correction adjustment is not necessary except for the Position 2 and Position 3 mounting directions.

*2: Input the model number and identifier of the replacement measurement module using the following procedure:

(1) For *5450 f*, select the model number appropriate for the pipe size of the main path.

Model number	Pipe size	<i>5450 f</i> setting
MCF0250	1B	2
MCF0400	1 1/2B	3
MCF0500	2B	4

(2) Check the number (15 digits) shown on the label on the main flow path and register the numbers for flow path identifiers 0 to 2. Or, before making the replacement, record in advance the settings for flow path identifiers 0 to 2 on the previous measurement module, and register them for the new replacement measurement module.

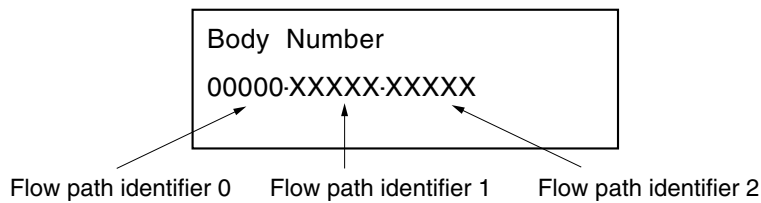

Note: Registering the wrong numbers for model number and flow path identifier may result in incorrect display of the flow rate.

(3) In *Pa.20*, the flow rate assignment for 20 mA analog output in the parameter setup (page 25), set one of the initial values shown below, as appropriate for the model number.

Model number	Setting value
MCF0250	03000
MCF0400	06000
MCF0500	12000

Chapter 6. MAINTENANCE AND TROUBLESHOOTING

⚠ CAUTION



When carrying the flowmeter or connecting it to the pipe, do not hold it by the measurement module. Doing so could cause damage, or the device could drop, causing an injury.



When maintaining or replacing the measurement module, release the internal pressure of this device before removing the measurement module.

■ Maintenance

Be sure to confirm that the MCF is operating normally by inspecting it periodically once or more per year. The MCF has a self-diagnosis function. If an alarm code does not disappear after taking countermeasures, contact the azbil Group or your dealer. Repair or replacement might be necessary.

Since the MCF____F has received oil-inhibiting treatment, be careful not to contaminate the gas flow passage during maintenance or replacement of the measuring unit.

● Measurement module parts

- Side view of measurement module

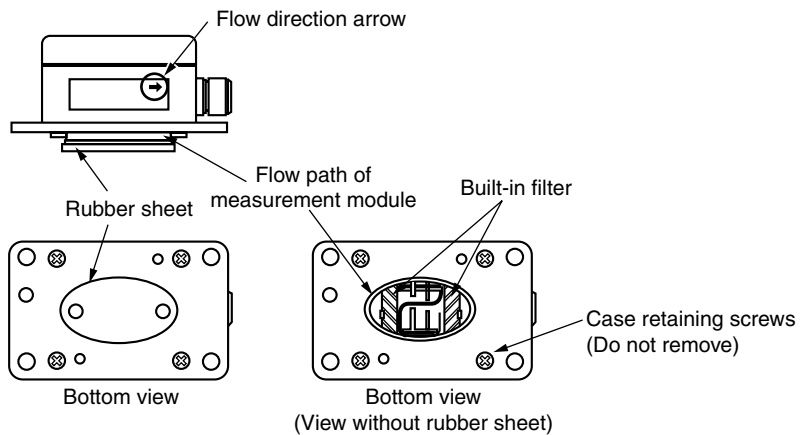

- View without measurement module

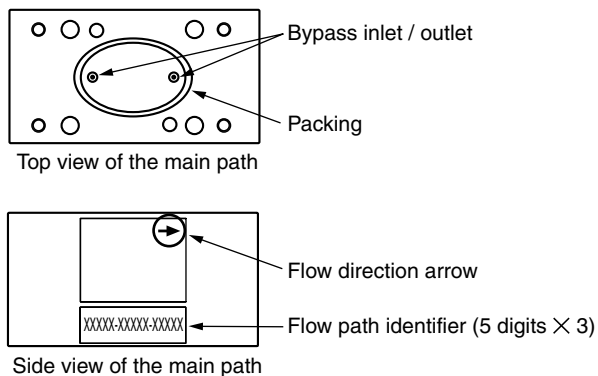

● **Maintaining the measurement module**

Required items: Allen wrench (M5), Air blower, protective goggles, helmet, gloves.

! **Handling Precautions**

- For your safety, wear goggles while taking the measurement module off.

- (1) Release the air pressure from the MCF and pipes, and then make sure that the gauge pressure is zero.
- (2) Take the four bolts off by loosening them bit by bit in a diagonal pattern.

! **Handling Precautions**

- Do not clean the measurement module path (bypass path) directly with a blower or the like. Doing so can damage the sensor by blowing foreign matter into it.
- (3) After detaching the measurement module from the MCF, clean the surface above the main path and the bypass inlet/outlet to the measurement module with a blower. At this point, the rubber sheet and the built-in filter might still be affixed to the main path. Before cleaning, take them off. After cleaning, reattach the rubber sheet and filter to the main path. Also, remove the packing and clean it.
 - (4) Make sure that the parts of measurement module are assembled correctly and that the packing is in place in the main path, and then attach the measurement module to the main path with the four bolts, matching the direction of the arrows. Tighten the bolts evenly to the specified torque (2.6 to 3.3 N·m).
 - (5) After the measurement module is attached, be sure that the displayed instantaneous flow rate is zero when the power is turned on.
 - (6) Supplying air pressure to the flowmeter and inside of the pipe, make sure that the instantaneous flow rate shows zero when there is no flow.
 - (7) Be sure that the air does not leak.

! **Handling Precautions**

- The measurement accuracy is $\pm 5\%FS \pm 1$ digit after the measurement module is reattached.

● **Replacing the measurement module on the MCF0250, MCF0400 and MCF0500**

- (1) The same as steps 1–3 in ● Maintaining the measurement module.
- (2) Make sure that the parts of new measurement module are assembled correctly and that the packing is in place in the main path, and then attach the measurement module to the main path with the four bolts, matching the direction of the arrows. Tighten the bolts evenly to the specified torque (2.6 to 3.3 N·m).
- (3) After the new measurement module is attached, input the flow path identifier after the power is turned on.
- (4) Be sure that the instantaneous flow rate shows zero.

- (5) Supplying air pressure to the flowmeter and inside of the pipe, make sure that the instantaneous flow rate shows zero when there is no flow.
- (6) Be sure that the air does not leak.
- (7) After replacement, enter the replacement date in the space marked “Date” at the bottom of the unit change label, and attach the label to the MCF.

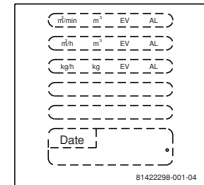

! Handling Precautions

- The measurement accuracy is $\pm 5\%FS \pm 1$ digit after the measurement module is replaced with a new one.
- When replacing an RS-485 communications model with a 4 to 20 mA output model, or vice versa, make sure that there are no wiring errors before turning on the MCF, in order to protect the connected equipment from damage.

📖 Note

- Flow path identifier.
The flow path identifier is a property of the main path. It refers to the diversion ratio adjustment of the main path. The flow path identifiers 0 to 2 correspond to diversion ratio adjustments 0 to 2. If the flow path identifier is registered in the measurement module in maintenance mode, the MCF can adjust the output for the properties of the main path. Therefore the MCF is able to maintain accuracy.

■ Troubleshooting

● Remedy for abnormal phenomena

Phenomenon	Remedy
The display does not indicate anything.	<ul style="list-style-type: none"> • Check that the supplied power and polarity are correct. • Check that the connector is connected correctly.
Shutting the front and back valves of the MCF, etc., the actual flow rate should be zero, but the flow rate display does not indicate zero.	<ul style="list-style-type: none"> • Check for air leaks • Check that wiring is correct. • When the MCF is mounted on a horizontal pipe and the display unit faces the side, zero point drift may be caused by the mounting direction. Set the low flow cutoff to 5 %FS. • If the MCF is mounted where the ambient temperature or the temperature of the measured gas fluctuates widely, the MCF might detect convection inside the pipe as a flow. Try measuring after the temperature stabilizes.
Measurement error has increased and exceeds the accuracy specifications.	<ul style="list-style-type: none"> • Check for air leaks. • Check if foreign matter is stuck on the main path orifices. If so, remove it. • After detaching the measurement module from the main path, check if foreign matter is present or stuck on the bypass inlet/outlet of the main path. If so, blow it off with compressed air. • After detaching the measurement module from the main path, check if the internal filter is stained. If so, clean it. • Check if foreign substances such as dust or oil are present on the pipe or the connection port of the MCF. If so, ask Azbil Corporation for repair. • Check that the wiring is correct. • Check if the flow fluctuates widely, or if it greatly exceeds the measurable limit. • Check if there is a pulsation source.

● Alarm codes and remedies

Alarm code	Item	Contents	Causes	Remedy
<i>RL40</i>	Flow rate range exceeded	Flow exceeds the upper limit for indication. Or, the flow exceeds the reverse flow rate range.	A forward or reverse flow exceeds the specified range.	Check for excessive flow. If a minus sign is shown on the flow rate display when the alarm occurs, there might be a reverse flow. Correct the factor causing the reverse flow. When the actual flow enters the normal range, the alarm lamp should turn off.
<i>RL51</i>	Registered data error 1	The registered flow path identifiers are incorrect. Flow rate cannot be calculated correctly.	Wrong flow path identifiers setting.	Set the correct flow path identifiers in maintenance mode. If the MCF does not return to normal after the setting is changed, reboot it. If the MCF does not return to normal after being restarted, call for repair.
<i>RL52</i>	Registered data error 2	The registered properties of the flow sensor are incorrect. The flow rate cannot be calculated correctly.	The registered properties might be corrupted. Or, abnormal heater voltage might be preventing proper calculation.	If the MCF does not return to normal after rebooting, call for repair.
<i>RL81</i>	Sensor error 1	The flow signal is outside the normal range.	The flow signal can decrease greatly if foreign matter causes a short circuit or if there is an excessive reverse flow.	If the cause of this alarm is excessive reverse flow, the MCF will return to normal automatically when the flow falls within the measurable range. If the alarm does not turn off in spite of a normal reverse flow, ask for repair.
<i>RL82</i>	Sensor error 2	The flow signal may differ from the actual flow.	The sensor might be broken or the output level might have decreased. Foreign matter or condensation may be present on the sensor.	If the MCF does not return to normal after a few hours of dry air flow, call for repair.
<i>RL83</i>	Sensor error 3			
<i>RL84</i>	Sensor error 4	Sensor heater voltage is outside the normal range.	The sensor may be broken or foreign matter may be stuck to it, causing a short circuit.	If the MCF does not return to normal after a few hours, call for repair.
<i>RL91</i>	Memory error	Device data error	Checksum error during EEPROM read/write process.	Data might be corrupted by electrical noise.
<i>RL92</i>		Property error		
<i>RL93</i>		Setup data error	EEPROM write process might have ended abnormally due to power outage.	Try data setup again. If the MCF does not return to normal after rebooting, call for repair.
<i>RL94</i>		Integrated data error		After resetting the integrated flow, if the MCF does not return to normal after rebooting, call for repair.

Chapter 7. SPECIFICATIONS

■ General specifications

Characteristics in this table are under the standard conditions shown below, unless otherwise specified.

- Operating environment: Standard (see page 39)
- Measured gas: Air
- Pressure: 0.3 ±0.025 MPa
- Flow rate value: Converted to 0 °C, 101.325 kPa (abs)
- Settings: Factory defaults
- Warm-up time: 30 minutes after power on

Item		MCF0080	MCF0150	MCF0151	MCF0250	MCF0400	MCF0500
Measured gas		Air, N2. Gas must be dry and not contain corrosive components such as chlorine, sulfur and acid. Gas must be a clean, without dust or oil mist.					
Full scale (FS) flow rate [L/min]		200	500	1000	3000	6000	12000
Minimum sensitivity [L/min]		2	5	10	30	60	120
Indication resolution [L/min] (Note 1)	Instantaneous flow rate	1	1	2	5	10	10
	Integrated flow	10	10	10	10	100	100
Maximum display range	[L/min]	-60 to +400	-150 to +1000	-300 to +2000	-900 to +6000	-1800 to +12000	-3600 to +24000
	[m ³ /h]	-3.6 to +24.0	-9.0 to +60.0	-18.0 to +120.0	-54.0 to +360	-108.0 to +720.0	-220.0 to +1440.0
	[m ³ /min]	-0.060 to +0.400	-0.150 to +1.000	-0.300 to +2.000	-0.900 to +6.000	-1.800 to +12.000	-3.600 to +24.000
	[kg/h]	-4.7 to +31.0	-11.6 to +77.6	-23.2 to +155.2	-70 to +465.5	-140.0 to +931.0	-279.0 to +1862.0
Indication accuracy for instantaneous flow rate		±3 %FS ±1 digit (except 2 % or less of FS flow rate) (Note 4, 5)					
Indication repeatability for instantaneous flow rate		±1 %FS ±1 digit (2 to 100 % of FS flow rate)					
Temperature characteristics		±0.15 %FS / °C ±1 digit or less					
Pressure characteristics for instantaneous flow rate	Operating pressure 0 to 1 MPa	-0.25 %FS / 0.1 MPa ±1 digit or less (2 to 40 % of FS flow rate) -0.55 %FS / 0.1 MPa ±1 digit or less (40 to 100 % of FS flow rate)					
	Operating pressure -0.07 to 0 MPa	±0.25 %FS / 0.01 MPa ±1 digit or less (2 to 40 % of FS flow rate) ±0.55 %FS / 0.01 MPa ±1 digit or less (40 to 100 % of FS flow rate)					
Pressure characteristics of instantaneous flow rate for Position 2 mounting (Note 2)	Operating pressure 0 to 1 MPa	0.5 %FS / 0.1 MPa ±1 digit or less (5 to 100 % of FS flow rate)					
	Operating pressure -0.07 to 0 MPa	0.5 %FS / 0.01 MPa ±1 digit or less (5 to 100 % of FS flow rate)					
Pressure characteristics of instantaneous flow rate for Position 3 mounting (Note 3)	Operating pressure 0 to 1 MPa	-0.5 %FS / 0.1 MPa ±1 digit or less (5 to 100 % of FS flow rate)					
	Operating pressure -0.07 to 0 MPa	-0.5%FS/0.01MPa ±1digit or less (5 to 100% of FS flow rate)					

*: FS flow rate indicator full scale flow rate.

Notes: 1. The indication resolution shows the smallest displayable digit, regardless of the position of the decimal point or the flow rate units.

2. Horizontal piping with the display facing right as seen from the air inlet.

3. Horizontal piping with the display facing left as seen from the air inlet.

4. Measuring accuracy becomes ±5 %FS ±1 digit after the measurement module is reassembled.

5. The measuring accuracy becomes ±5 %FS ±1 digit after the measurement module is replaced with a new one. (For MCF0250, MCF0400 and MCF0500)

Chapter 7. SPECIFICATIONS

Item	MCF0080	MCF0150	MCF0151	MCF0250	MCF0400	MCF0500
Operating pressure range	-0.07 to +1.0 MPa (gauge pressure)					
Operating temperature range	-10 to +60 °C (without freezing)					
Operating humidity range	0 to 90 % RH (without condensation)					
Storage temperature range	-20 to +70 °C (without freezing)					
Storage humidity range	0 to 90 % RH (without condensation)					
Pressure resistance	1.5 MPa (gauge pressure)					
Allowable leakage rate	100 mL/h (at internal pressure of 1.5 MPa)					
Pipe size (Rc or G depending on model)	1/4 inch	1/2 inch	1/2 inch	1 inch	1 1/2 inch	2 inch
Rated voltage	24 Vdc					
Power supply range	22.8 to 25.2 Vdc					
Current consumption	120 mA max.					
Measurement cycle	50 ±5 ms (factory setting)					
Instantaneous flow rate output (4 to 20 mA output models only)	Current output: 4 to 20 mA (3.2 to 20.8 mA of output range) Output at alarm occurrence (upper): 21.6 ±0.4 mA (factory setting, variable by function setup) Output at alarm occurrence (lower): 0.0 ±0.4 mA (fixed) Allowable load resistance: 300 Ω max. Maximum output current: 24 mA max.					
Response time	1.5 s max. (time until 95 % of final value for response to 0 to 100 %FS step input, with 50 ms measurement cycle and calculation filter 8.) (Note 6)					
Event output (Note 7)	NPN open collector: 30 Vdc, 50 mA max Selectable from following functions: <ul style="list-style-type: none"> • Instantaneous flow rate switch (upper limit, lower limit, within range) • Integrated flow switch (count-up, countdown) • Integrated pulse output (3 assignable pulse weights) • Alarm output 					
RS-485 communications (RS-485 communications models only)	3-wire type Transmission speed: 4800, 9600, and 19200 bps Protocol: Modbus					
Data storage	EEPROM non-volatile semiconductor memory					
Dielectric strength	1 mA or less of leak current when 500 Vac is applied for 1 s between contacts of connector and main flow path or mounting bolts.					
Insulation resistance	50 MΩ or more between contacts of connector and main flow path or mounting bolts, with 500 Vdc megger					
Protective structure	IP65 (JIS C0920 and IEC529) ingress protection for indoor installation					
Measurement module mounting bolt tightening torque	2.6 to 3.3 N·m					
Standards compliance	EN61326-2-3 / EN61326-1 (to be used in an industrial electromagnetic environment) During EMC testing, the reading or output may fluctuate by ±20 % FS.					
Mass	Approx. 400 g	Approx. 400 g	Approx. 400 g	Approx. 500 g	Approx. 700 g	Approx. 1.1 kg

Notes: 6. The 50 ms measurement cycle becomes approx. 0.5 s if the calculation filter is set to "1."

7. For RS-485 communications models, there is no terminal output. The LED indicator lamp lights up, and a state flag can be read out.

● Material and treatments

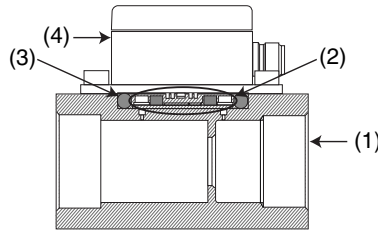

Model number	MCF___A_____	MCF___F_____
(1) Main flow path	Aluminum alloy (alumite treatment)	Aluminum alloy (alumite treatment, ultrasonic cleaning, immersed in cleaning solution)
(2) Measurement module	SUS304, PBT, HNBR, Urethane foam	SUS304 (immersion in cleaning solution), PBT, FKM, Urethane foam
(3) Packing	HNBR	FKM (immersion in cleaning solution)
(4) Measurement module electronic component case	Modified PPO	Modified PPO

Note: The main flow passage of G thread models has no alumite treatment.

■ Environmental conditions

● Standard conditions

Ambient temperature	23 ±3 °C
Ambient humidity	60 ±5 % RH
Rated power supply	24 Vdc
Vibration	0 m/s ²
Shock	0 m/s ²
Mounting direction	Mounting on horizontal pipes with display upward

● Operating conditions

Ambient temperature	-10 to +60 °C (without freezing)
Ambient humidity	0 to 90 % RH (without condensation)
Rated power supply	22.8 to 25.2 Vdc
Vibration	0 m/s ²
Shock	0 m/s ²
Mounting direction	Horizontal or vertical

● Transport/storage conditions

Ambient temperature	-20 to +70 °C
Ambient humidity	0 to 90 % RH
Vibration	10 to 500 Hz, with 1.5 mm amplitude or 98 m/s ² acceleration
Shock	490 m/s ²
Package drop	Drop height 60 cm (1 corner, 3 edges and 6 surfaces, free fall)

■ External dimensions

● MCF0080

Unit : mm

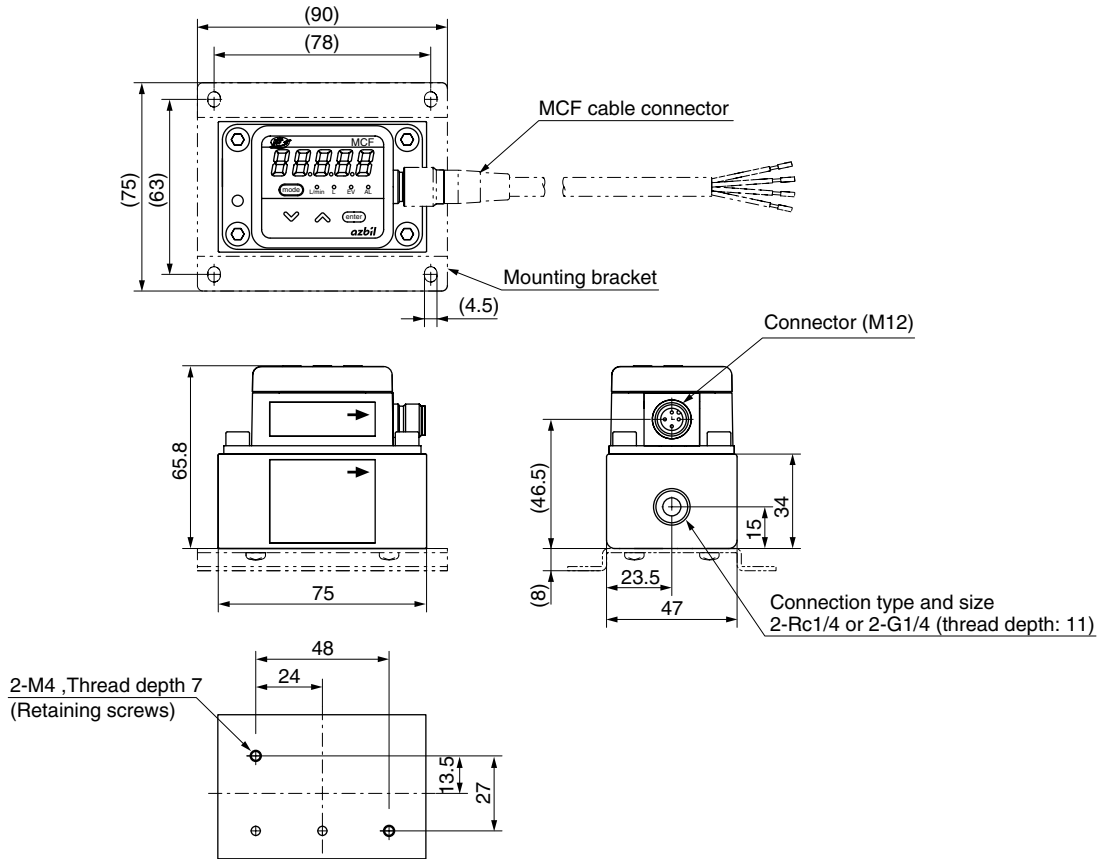

● MCF0150/MCF0151

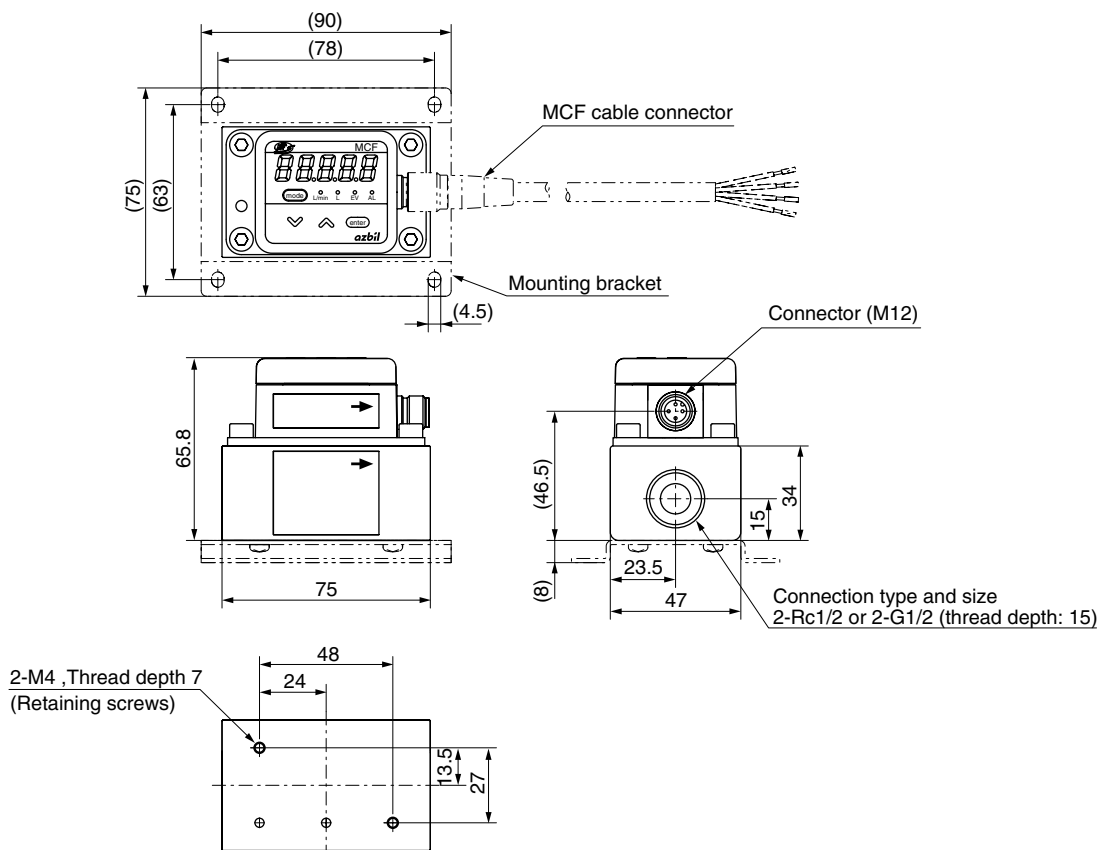

● MCF0250

Unit : mm

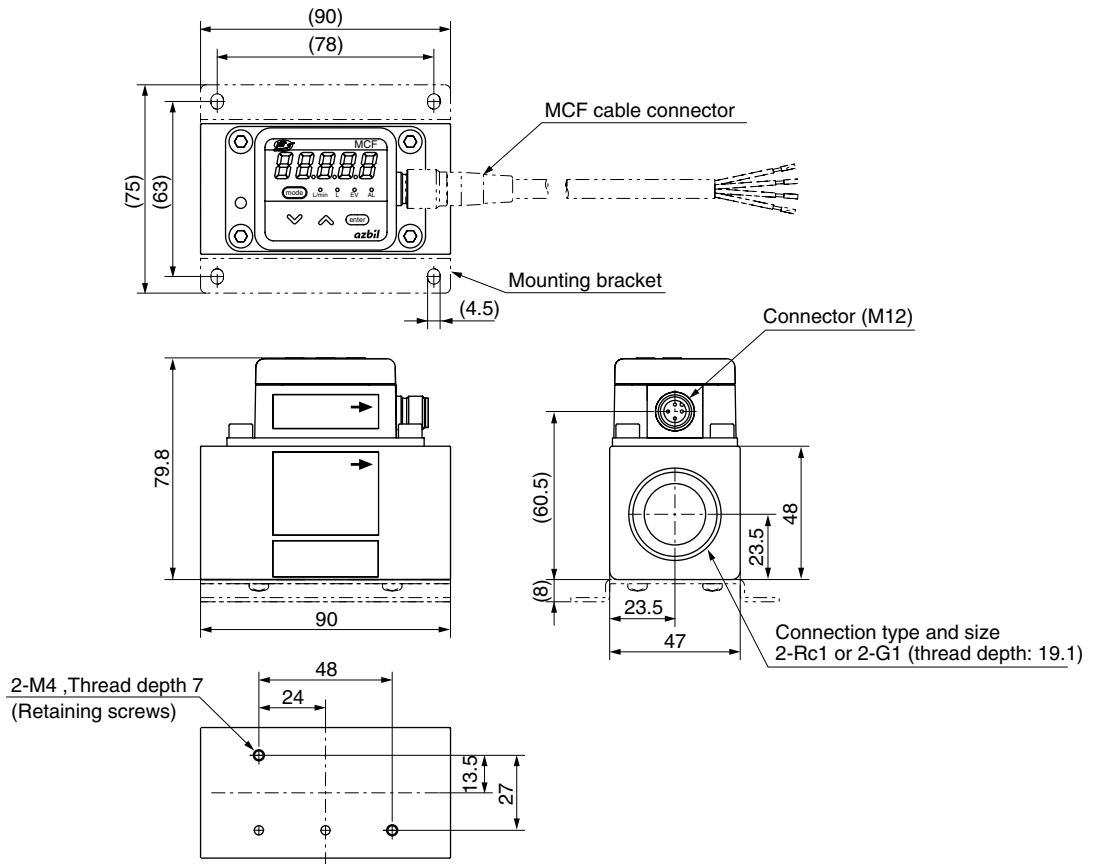

● MCF0400

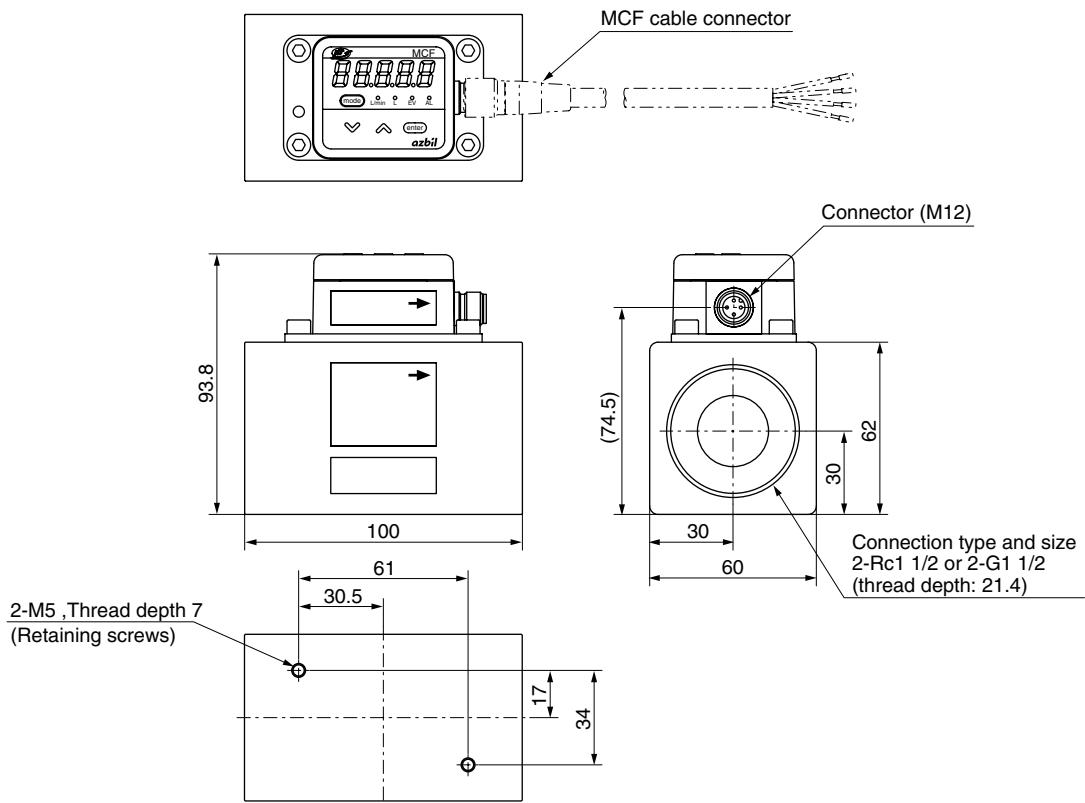

● MCF0500

Unit : mm

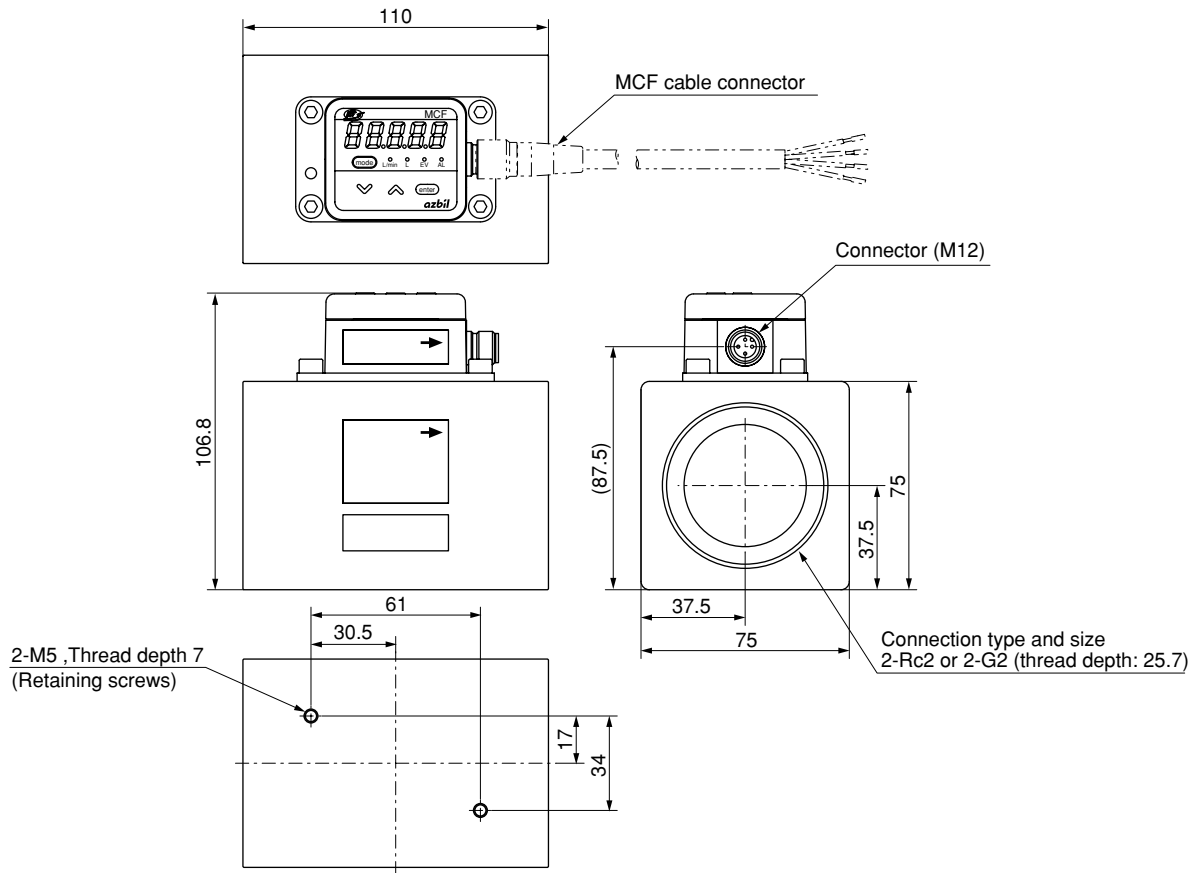

■ Pressure loss

Typical characteristics are shown below. Characteristics for 0-100 %FS flow rate are shown on the left and characteristics for 100-200 %FS flow rate are shown on the right.

● MCF0080 (1/4 inch)

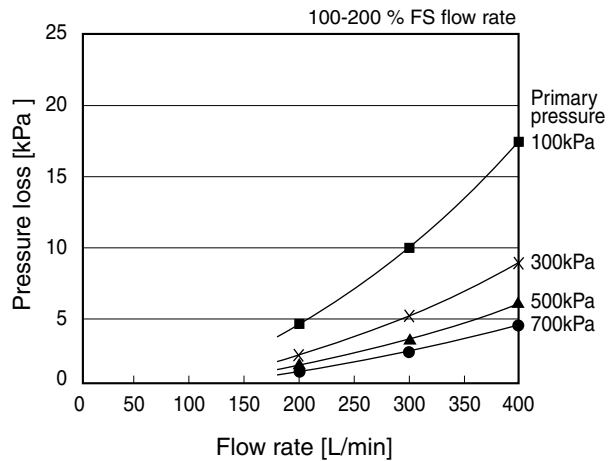
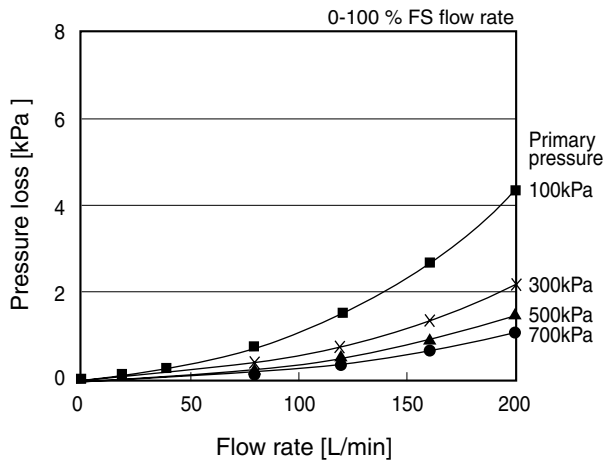

● MCF0150 (1/2 inch)

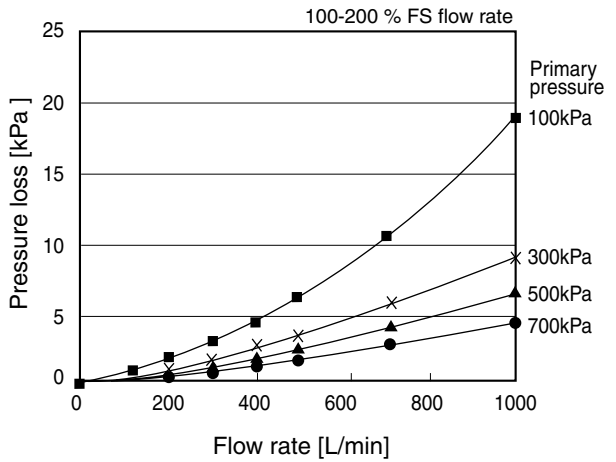
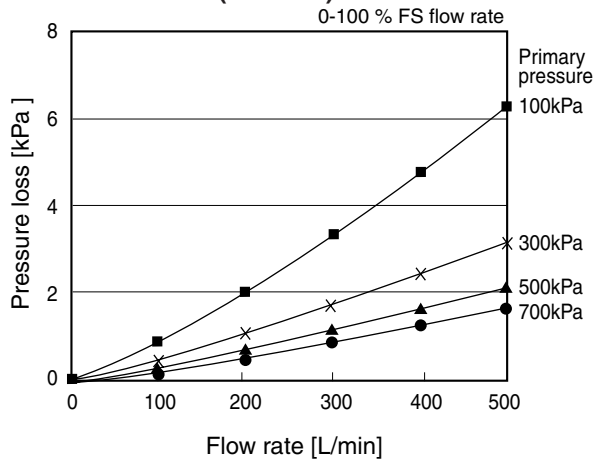

● MCF0151 (1/2 inch)

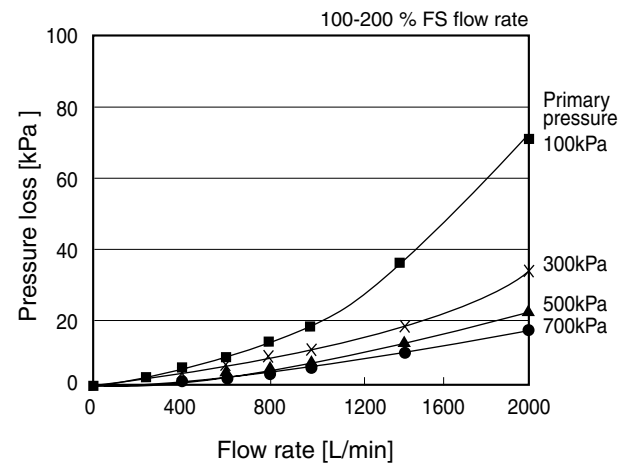
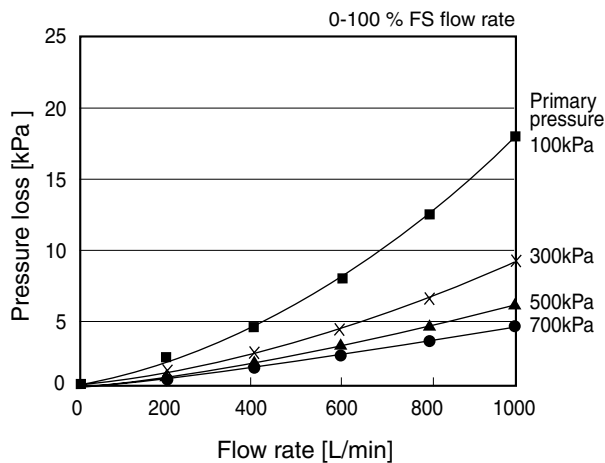

● MCF0250 (1 inch)

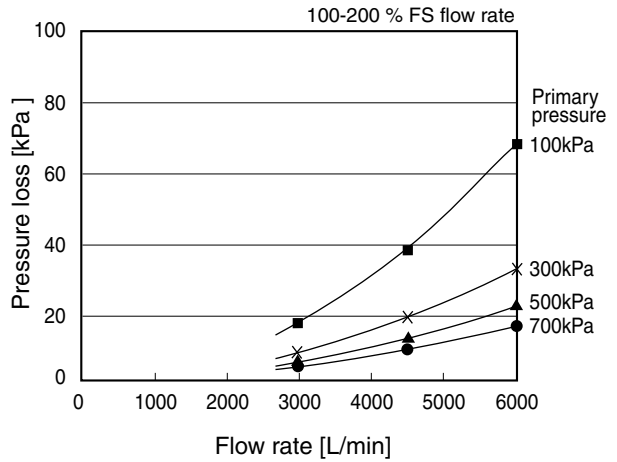
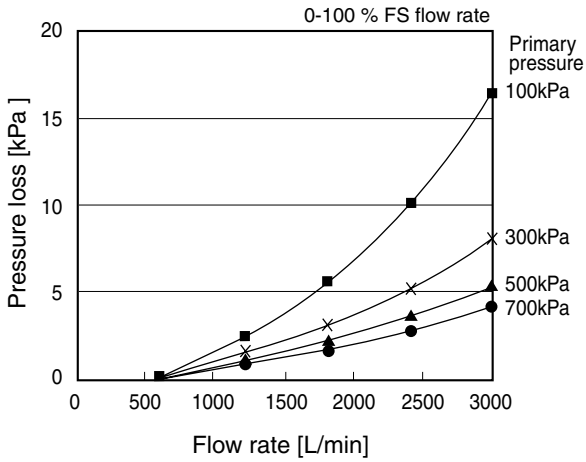

● MCF0400 (1 1/2 inch)

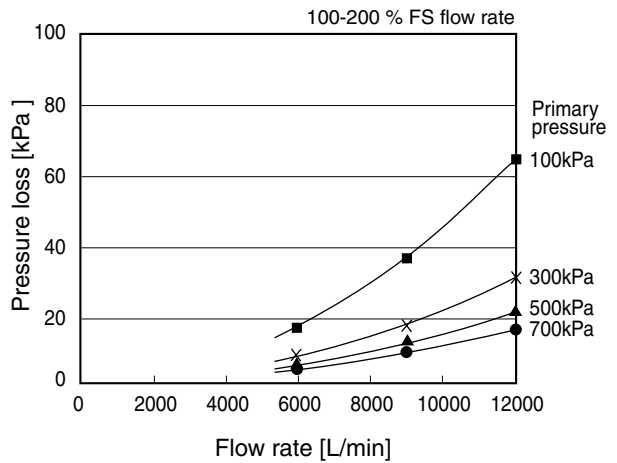
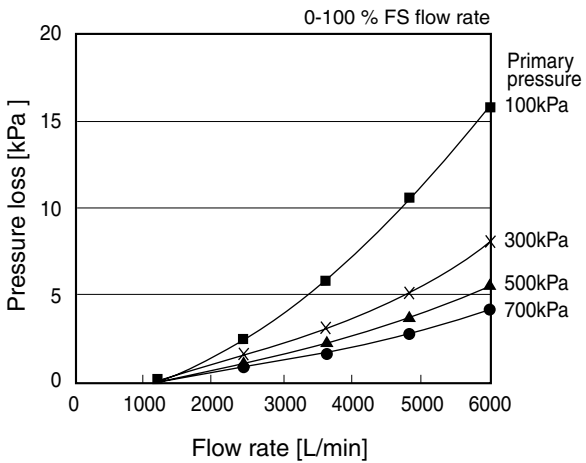

● MCF0500 (2 inch)

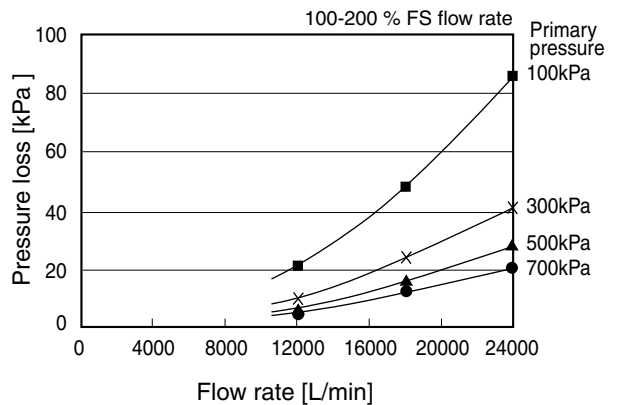
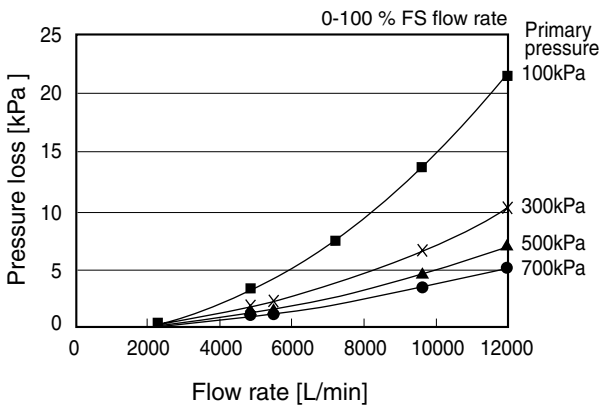

Revision History

Printed date	Manual Number	Edition	Revised pages	Description
Dec. 2008	CP-SP-1276E	1st Edition		
June 2009		2nd Edition		Overall revision
Nov. 2009		3rd Edition	2 5 6 7 to 44 22 24 33 38 39 40 to 42	Model selection guide and Measurement module section of Optional parts were changed. MCF_____R pipe installation cautions were changed. MCF_____G pipe installation cautions added. Old pages 6 to 43 Function settings CO2 : addition to Description section Note 5 added. Maintenance: sentence added. Standards compliance: UL added. Material and treatments section added. G thread details added.
Apr. 2012		4th Edition		Company name changed.
Nov. 2023		5th Edition	14 38	Wiring example: Deleted “Azbil Corporation’s CMC10L001A000 can be used as a converter of the host station.” Standards compliance: Changed the description.

Terms and Conditions

We would like to express our appreciation for your purchase and use of Azbil Corporation's products.

You are required to acknowledge and agree upon the following terms and conditions for your purchase of Azbil Corporation's products (system products, field instruments, control valves, and control products), unless otherwise stated in any separate document, including, without limitation, estimation sheets, written agreements, catalogs, specifications and instruction manuals.

1. Warranty period and warranty scope

1.1 Warranty period

Azbil Corporation's products shall be warranted for one (1) year from the date of your purchase of the said products or the delivery of the said products to a place designated by you.

1.2 Warranty scope

In the event that Azbil Corporation's product has any failure attributable to azbil during the aforementioned warranty period, Azbil Corporation shall, without charge, deliver a replacement for the said product to the place where you purchased, or repair the said product and deliver it to the aforementioned place. Notwithstanding the foregoing, any failure falling under one of the following shall not be covered under this warranty:

- (1) Failure caused by your improper use of azbil product (noncompliance with conditions, environment of use, precautions, etc. set forth in catalogs, specifications, instruction manuals, etc.);
- (2) Failure caused for other reasons than Azbil Corporation's product;
- (3) Failure caused by any modification or repair made by any person other than Azbil Corporation or Azbil Corporation's subcontractors;
- (4) Failure caused by your use of Azbil Corporation's product in a manner not conforming to the intended usage of that product;
- (5) Failure that the state-of-the-art at the time of Azbil Corporation's shipment did not allow Azbil Corporation to predict; or
- (6) Failure that arose from any reason not attributable to Azbil Corporation, including, without limitation, acts of God, disasters, and actions taken by a third party.

Please note that the term "warranty" as used herein refers to equipment-only-warranty, and Azbil Corporation shall not be liable for any damages, including direct, indirect, special, incidental or consequential damages in connection with or arising out of Azbil Corporation's products.

2. Ascertainment of suitability

You are required to ascertain the suitability of Azbil Corporation's product in case of your use of the same with your machinery, equipment, etc. (hereinafter referred to as "Equipment") on your own responsibility, taking the following matters into consideration:

- (1) Regulations and standards or laws that your Equipment is to comply with.
- (2) Examples of application described in any documents provided by Azbil Corporation are for your reference purpose only, and you are required to check the functions and safety of your Equipment prior to your use.
- (3) Measures to be taken to secure the required level of the reliability and safety of your Equipment in your use

Although azbil is constantly making efforts to improve the quality and reliability of Azbil Corporation's products, there exists a possibility that parts and machinery may break down. You are required to provide your Equipment with safety design such as fool-proof design,*1 and fail-safe design*2 (anti-flame propagation design, etc.), whereby preventing any occurrence of physical injuries, fires, significant damage, and so forth. Furthermore, fault avoidance,*3 fault tolerance,*4 or the like should be incorporated so that the said Equipment can satisfy the level of reliability and safety required for your use.

*1. A design that is safe even if the user makes an error.

*2. A design that is safe even if the device fails.

*3. Avoidance of device failure by using highly reliable components, etc.

*4. The use of redundancy.

3. Precautions and restrictions on application

3.1 Restrictions on application

Please follow the table below for use in nuclear power or radiation-related equipment.

	Nuclear power quality*5 required	Nuclear power quality*5 not required
Within a radiation controlled area*6	Cannot be used (except for limit switches for nuclear power*7)	Cannot be used (except for limit switches for nuclear power*7)
Outside a radiation controlled area*6	Cannot be used (except for limit switches for nuclear power*7)	Can be used

*5. Nuclear power quality: compliance with JEAG 4121 required

*6. Radiation controlled area: an area governed by the requirements of article 3 of "Rules on the Prevention of Harm from Ionizing Radiation," article 2 2 4 of "Regulations on Installation and Operation of Nuclear Reactors for Practical Power Generation," article 4 of "Determining the Quantity, etc., of Radiation-Emitting Isotopes," etc.

*7. Limit switch for nuclear power: a limit switch designed, manufactured and sold according to IEEE 382 and JEAG 4121.

Any Azbil Corporation's products shall not be used for/with medical equipment.

The products are for industrial use. Do not allow general consumers to install or use any Azbil Corporation's product. However, azbil products can be incorporated into products used by general consumers. If you intend to use a product for that purpose, please contact one of our sales representatives.

3.2 Precautions on application

you are required to conduct a consultation with our sales representative and understand detail specifications, cautions for operation, and so forth by reference to catalogs, specifications, instruction manual, etc. in case that you intend to use azbil product for any purposes specified in (1) through (6) below. Moreover, you are required to provide your Equipment with fool-proof design, fail-safe design, anti-flame propagation design, fault avoidance, fault tolerance, and other kinds of protection/safety circuit design on your own responsibility to ensure reliability and safety, whereby preventing problems caused by failure or nonconformity.

- (1) For use under such conditions or in such environments as not stated in technical documents, including catalogs, specification, and instruction manuals
- (2) For use of specific purposes, such as:
 - * Nuclear energy/radiation related facilities
[When used outside a radiation controlled area and where nuclear power quality is not required]
[When the limit switch for nuclear power is used]
 - * Machinery or equipment for space/sea bottom
 - * Transportation equipment
[Railway, aircraft, vessels, vehicle equipment, etc.]
 - * Antidisaster/crime-prevention equipment
 - * Burning appliances
 - * Electrothermal equipment
 - * Amusement facilities
 - * Facilities/applications associated directly with billing
- (3) Supply systems such as electricity/gas/water supply systems, large-scale communication systems, and traffic/air traffic control systems requiring high reliability
- (4) Facilities that are to comply with regulations of governmental/public agencies or specific industries
- (5) Machinery or equipment that may affect human lives, human bodies or properties
- (6) Other machinery or equipment equivalent to those set forth in items (1) to (5) above which require high reliability and safety

4. Precautions against long-term use

Use of Azbil Corporation's products, including switches, which contain electronic components, over a prolonged period may degrade insulation or increase contact-resistance and may result in heat generation or any other similar problem causing such product or switch to develop safety hazards such as smoking, ignition, and electrification. Although acceleration of the above situation varies depending on the conditions or environment of use of the products, you are required not to use any Azbil Corporation's products for a period exceeding ten (10) years unless otherwise stated in specifications or instruction manuals.

5. Recommendation for renewal

Mechanical components, such as relays and switches, used for Azbil Corporation's products will reach the end of their life due to wear by repetitious open/close operations.

In addition, electronic components such as electrolytic capacitors will reach the end of their life due to aged deterioration based on the conditions or environment in which such electronic components are used. Although acceleration of the above situation varies depending on the conditions or environment of use, the number of open/close operations of relays, etc. as prescribed in specifications or instruction manuals, or depending on the design margin of your machine or equipment, you are required to renew any Azbil Corporation's products every 5 to 10 years unless otherwise specified in specifications or instruction manuals. System products, field instruments (sensors such as pressure/flow/level sensors, regulating valves, etc.) will reach the end of their life due to aged deterioration of parts. For those parts that will reach the end of their life due to aged deterioration, recommended replacement cycles are prescribed. You are required to replace parts based on such recommended replacement cycles.

6. Other precautions

Prior to your use of Azbil Corporation's products, you are required to understand and comply with specifications (e.g., conditions and environment of use), precautions, warnings/cautions/notices as set forth in the technical documents prepared for individual Azbil Corporation's products, such as catalogs, specifications, and instruction manuals to ensure the quality, reliability, and safety of those products.

7. Changes to specifications

Please note that the descriptions contained in any documents provided by azbil are subject to change without notice for improvement or for any other reason. For inquires or information on specifications as you may need to check, please contact our branch offices or sales offices, or your local sales agents.

8. Discontinuance of the supply of products/parts

Please note that the production of any Azbil Corporation's product may be discontinued without notice. After manufacturing is discontinued, we may not be able to provide replacement products even within the warranty period.

For repairable products, we will, in principle, undertake repairs for five (5) years after the discontinuance of those products. In some cases, however, we cannot undertake such repairs for reasons, such as the absence of repair parts. For system products, field instruments, we may not be able to undertake parts replacement for similar reasons.

9. Scope of services

Prices of Azbil Corporation's products do not include any charges for services such as engineer dispatch service. Accordingly, a separate fee will be charged in any of the following cases:

- (1) Installation, adjustment, guidance, and attendance at a test run
- (2) Maintenance, inspection, adjustment, and repair
- (3) Technical guidance and technical education
- (4) Special test or special inspection of a product under the conditions specified by you

Please note that we cannot provide any services as set forth above in a nuclear energy controlled area (radiation controlled area) or at a place where the level of exposure to radiation is equivalent to that in a nuclear energy controlled area.

azbil

Azbil Corporation
Advanced Automation Company

1-12-2 Kawana, Fujisawa
Kanagawa 251-8522 Japan

URL: <http://www.azbil.com>

Specifications are subject to change without notice. (09)

1st edition: Dec. 2008 (M)
5th edition: Nov. 2023 (S)