

Sapphire Capacitance Diaphragm Gauge

Model SPG __ User's Manual



Thank you for purchasing an Azbil Corporation product.

This manual contains information for ensuring the correct use of this product. It also provides necessary information for installation, maintenance, and troubleshooting.

This manual should be read by those who design and maintain equipment that uses this product.

Be sure to keep this manual nearby for handy reference.

Please read "Terms and Conditions" from the following URL before ordering and use.

<https://www.azbil.com/products/factory/order.html>

NOTICE

Be sure that the user receives this manual before the product is used.

Copying or duplicating this user's manual in part or in whole is forbidden. The information and specifications in this manual are subject to change without notice.

Considerable effort has been made to ensure that this manual is free from inaccuracies and omissions. If you should find an error or omission, please contact the azbil Group.

In no event is Azbil Corporation liable to anyone for any indirect, special or consequential damages as a result of using this product.

SAFETY PRECAUTIONS

Safety precautions are for ensuring safe and correct use of this product, and for preventing injury to the operator and other people or damage to property. You must observe these safety precautions. Also, be sure to read and understand the contents of this user's manual.

● Key to symbols

WARNING

Warnings are indicated when mishandling this product might result in death or serious injury to the user.

CAUTION

Cautions are indicated when mishandling this product might result in minor injury to the user, or only physical damage to this product.

WARNING

 The burst pressure is the pressure at which this device will break. To avoid an accident, never apply pressure exceeding the burst pressure.

 Do not use this device in explosive atmospheres or near flammable fluids or steam.

WARNING

 Always use the specified fittings and gaskets. After the piping work has been completed, check that there are no gas leaks before operating the device.

 The surface of this device is very hot while the power is ON and for a while after the power has been turned OFF. To avoid a burn, do not touch it during this period. When removing this device, turn the power OFF and allow sufficient time for it to cool. If there is a chance that work personnel will come in contact with this device after installation, take appropriate countermeasures. (Self-heating models)

CAUTION

 Use the device within the operating ranges recommended in the specifications (temperature, humidity, voltage, atmosphere, etc.). Using it outside these ranges might cause fire or device failure.

 When wiring the power for this device, be sure to install a master cut-off switch for the electrical power within easy reach of the operator.

 Wire the device properly according to the standards given in this document, using the specified power source and installation methods. Not doing so might result in fire or device failure.

 Do not allow wire or solder clippings, water, etc. to enter the case of this device. They could cause fire or device failure.

 Do not block ventilation holes. Doing so might cause fire or device failure.

 Use the relays in this device within the operating ranges recommended in the specifications. Otherwise, fire or device failure may result. If there is a possibility that the device will be used in conditions that are outside the range of the specifications, take appropriate countermeasures.

OVERVIEW

The device is a capacitance diaphragm vacuum gauge that uses a sapphire capacitance pressure sensor to achieve high accuracy and reliability, compact size, and light weight. Self-heating and non-self-heating models are available. On self-heating models, the heating temperature can be selected. The device is especially suited for use in semiconductor manufacturing. It features the following:

- A single-crystal sapphire pressure sensing medium, offering excellent corrosion resistance, ability to withstand high temperatures, and excellent mechanical characteristics. The capacitive measurement design provides high repeatability even when used in a high-temperature environment.
- Small size and light weight, achieved by micromachining technology.
- Advanced signal processing technology, contributing to excellent temperature characteristics and linearity of measurement.
- Microprocessor-based digital PID, providing fast warm-up time and stable sensor temperature control. (Self-heating models)
- A wide range of supply power voltages.
- Easy zero point adjustment with automatic adjustment button or up/down zero adjustment buttons.
- Model SLP-SP5 Smart Loader Package (sold separately), for easy monitoring of the device and setting of its parameters from a PC.
- Equipped with three event relays. Relay settings can be changed easily with the Smart Loader Package (model SLP-SP5, sold separately).
- Conformity to EMC directives; CE-marked; compliance with EN61326-1 and EN61326-2-3.

For information on the model SLP-SP5 Smart Loader Package, refer to User's Manual for Smart Loader Package Model SLP-SP5 for Sapphire Capacitance Diaphragm Gauge Model SPG __ (CP-UM-5499E).

Model selection table

I	II	III	IV	V	VI	VII	VIII	Example: SPG5AT11HD500500
Basic model No	Type	Additional function	Pressure range	Self-heating temperature	Fitting	Event 1 setting	Event 2 setting	
SPG								Sapphire capacitance diaphragm gauge
	5							Standard model
	6							Extra high-temperature model
	7							Vacuum freeze-drying process model
	8							High temperature heating model
		A						Standard model
		B						Atomic Layer Deposition (ALD) model
		C						ANTI-Deposition Model
			---					Refer to the table on the left
				R				Without self-heating function
				A				45 °C
				C				100 °C
				D				125 °C
				E				150 °C
				F				160 °C
				G				180 °C
				H				200 °C
				K				230 °C
				L				260 °C
				M				280 °C
					A			1/2 inch gauge port
					D			8 VCR (female) equivalent (SUS316L with electrolytic grinding)
					E			NW16
					H			IDF 1.5S ferrule
					J			IDF 2S ferrule
					P			1/2 inch gauge port, with traceability certificate
					S			8 VCR (female) equivalent (SUS316L with electrolytic grinding), with traceability certificate
					T			NW16, with traceability certificate
					W			IDF 1.5S ferrule, with traceability certificate
					Y			IDF 2S ferrule, with traceability certificate
					***			** %FS Always OFF if "NNN" is specified.
						***		** %FS Always OFF if "NNN" is specified.

Pressure code	FS pressure ranges (absolute pressure)	
T1R	13.332	Pa
T2R	26.664	Pa
T2S	33.331	Pa
T10	133.32	Pa
T20	266.64	Pa
T30	399.96	Pa
T11	1333.2	Pa
T21	2666.4	Pa
T31	3999.6	Pa
T51	6666.1	Pa
T12	13332	Pa
T22	26664	Pa
T13	133.32	kPa
P21	20	Pa
P2S	25	Pa
P12	100	Pa
P22	200	Pa
P32	300	Pa
P13	1000	Pa
P23	2000	Pa
P33	3000	Pa
P53	5000	Pa
P14	10000	Pa
P24	20000	Pa
P15	100	kPa

Possible model No. combinations

I + II	III			IV: Pressure range												
	A	B	C	T1R	T2R	T2S	T10	T20	T30	T11	T21	T31	T51	T12	T22	T13
SPG5	✓		✓				✓	✓	✓	✓	✓	✓		✓	✓	✓
SPG6	✓	✓	✓						✓	✓				✓	✓	✓
SPG7	✓						✓	✓	✓	✓	✓	✓		✓	✓	✓
SPG8	✓									✓	✓					✓
										✓	✓					✓
							✓	✓		✓	✓	✓		✓	✓	✓
										✓			✓			✓
													✓			✓

I + II + III	V: Self-heating temperature										
	R	A	C	D	E	F	G	H	K	L	M
SPG5A	✓			✓	✓	✓	✓	✓			
SPG5C		✓*	✓*		✓			✓			
SPG6A				✓	✓	✓	✓	✓			
SPG6B			✓*	✓	✓	✓	✓	✓			
SPG6C			✓*		✓			✓			
SPG7A				✓							
SPG8A									✓	✓	✓

I + II + III	VI: Fitting									
	A	D	E	H	J	P	S	T	W	Y
SPG5A	✓	✓	✓		✓	✓	✓	✓		✓
SPG5C		✓	✓				✓	✓		
SPG6A	✓	✓	✓		✓	✓	✓	✓		✓
SPG6B		✓					✓			
SPG6C		✓	✓				✓	✓		
SPG7A				✓	✓				✓	✓
SPG8A		✓					✓			

*IV (pressure range) must be less than 100 Pa.

Note: If a model No. combination that is not listed as possible is needed, please contact the azbil Group.

Part names

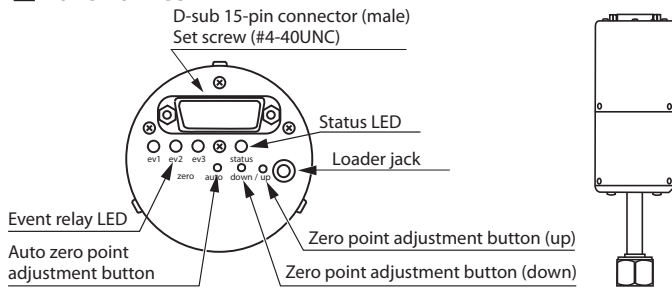

Smart Loader communication function

This device can be monitored and its parameters changed easily from a PC using the model SLP-SP5 Smart Loader Package.

For more detail, refer to User's Manual for Smart Loader Package Model SLP-SP5 for Sapphire Capacitance Diaphragm Gauge Model SPG __ (CP-UM-5499E).

Monitoring	Pressure monitor Model SPG__ internal status monitor • Temperature of electronics circuit and of sensor head; DC supply voltage • Alarm status, failure status	
Adjustment	Bias compensation Ratio compensation	
Configuration	0 to 10 V output settings	
	0 V pressure for 0-10 V output	
	10 V pressure for 0-10 V output	
	0-10 V output value (abnormal status)	
	Conditions for 0-10 V output (abnormal status)	
	Event relay settings	Always OFF.
		Normal status: ON, Abnormal status: OFF.
		Normal status: OFF, Abnormal status: ON.
		Normal status: ON, Abnormal status: latch OFF.
		Normal status: OFF, Abnormal status: latch ON.
		Warm-up done: ON, Warm-up in progress or abnormal status: OFF.
		Warm-up done: OFF, Warm-up in progress or abnormal status: ON.
		Warm-up done: ON, In progress: OFF, Abnormal status: OFF latch.
		Warm-up done: OFF, In progress: ON, Abnormal status: ON latch.
		Pressure high limit (direct action)
	Pressure low limit (direct action)	
Pressure high limit (reverse action)		
Pressure low limit (reverse action)		
Deviation high/low limit (Direct action)		
Deviation high/low limit (Reverse action)		
1st order filter time constant		
Instrumentation check	0 to 10 V output simulation	
	Event simulation	

Operation charts for pressure interlock of event relay

Pressure high limit (Direct action)

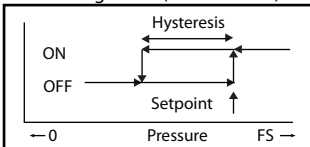

Pressure low limit (Direct action)

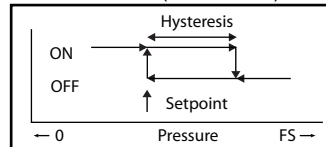

Pressure high limit (Reverse action)

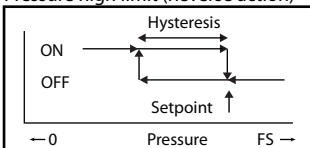

Pressure low limit (Reverse action)

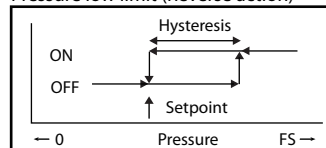

Deviation high/low limit (Direct action)

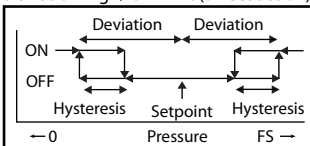

Deviation high/low limit (Reverse action)

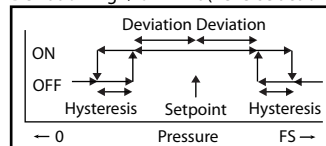

INSTALLATION

WARNING

Always use the specified fittings and gaskets. After the piping work has been completed, check that there are no gas leaks before operating the device.

When installing models with a VCR fitting on the pipe, tighten the nut by hand, and then tighten it with a wrench an additional 1/8 turn for an SUS316 stainless steel or nickel gasket, or 1/4 turn for a copper gasket. Excessive tightening may damage the seal. When you retighten the nut, always replace the gasket with new one. Before starting installation work, refer to the user's manual provided by the fitting manufacturer for cautions and the method of use. An incorrect pipe connection may lead to gas leaks.

CAUTION

Use the device within the operating ranges recommended in the specifications (for temperature, humidity, voltage, atmosphere, etc.). Using it outside these ranges might cause fire or device failure.

Installation locations

Do not install this product in a place with any of the following characteristics:

- Temperature or humidity outside the specified high and low limits
- Corrosive gases such as sulfide gas
- Dust or soot
- Direct sunlight, wind, or rain
- Mechanical vibration or shock outside the range of the specifications
- Proximity to high-voltage lines, welding machines, or other sources of electrical noise
- Within 15 m of a high-voltage ignition device for a boiler, etc.
- Strong magnetic fields
- Explosive atmosphere, and near flammable fluids or steam.

Installation

When connecting this device to the piping, always use the specified fittings and gaskets, and check for leaks after installation is complete. There are no limitations on mounting angle. However, since a zero-shift may occur at some angles, be sure to adjust the zero point after installation.

Handling Precautions

- Vibration may move the device's pressure-sensitive diaphragm, causing the pressure reading to fluctuate. Therefore, take appropriate measures so that this device is not subject to vibration. In particular, guard against vibration that would move the device along its axis (e.g., up-and-down vibration, if the device is mounted vertically).
- When installing, attach the fitting firmly, taking care not to apply any force to the case. Application of force to the case might break the device.
- This is a precision instrument. Do not drop it or bump it against any object. Application of any shock to this device might adversely affect its performance.
- The operating ambient temperature range varies depending on the presence or absence of cooling air. Install an appropriate cooling fan as necessary.

Note

- This device was calibrated at the factory in a vertical position. Shift of the zero point may have occurred, depending on the mounting angle. In such a case, accuracy can be recovered by adjusting the zero point after installation. Vertical installation is recommended to prevent contaminants from accumulating on the sensor unit.

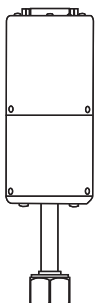

WIRING

⚠ WARNING



The surface of this device is very hot while the power is ON and for a while after the power has been turned OFF. To avoid a burn, do not touch it during this period. When removing this device, turn the power OFF and allow sufficient time for it to cool. If there is a chance that work personnel will come in contact with this device after installation, take appropriate countermeasures. (Self-heating models)

⚠ CAUTION



Wire the device properly according to the standards given in this document, using the specified power source and installation methods. Not doing so might result in fire or device failure.



Do not allow wire clippings, shavings, water, etc. to enter the case of this device. They could cause fire or device failure.



When wiring the power for this device, be sure to install a master cut-off switch for the electrical power within easy reach of the operator.



Be sure to use a cable that adequately satisfies the requirements for operating ambient temperatures.

■ Wiring Precautions

- Before wiring, mounting, or removing the device, be sure to turn the power OFF.
- Before starting the wiring work, check the model No. of this device and the connector pin assignments (see page 4). Make sure that the wiring is correct.
- Devices or systems to be connected to the device must have basic insulation sufficient to withstand the maximum operating voltage levels of the power supply and input/output components.
- Use a power supply suitable for instrumentation, and make sure that noise does not adversely affect this device.
- Use a power supply with a rated current equal to or greater than the maximum power current specified on p. 6 of this document.
- Use shielded cables for the wiring.
- Be sure to connect a ground wire to the frame ground.
- Use a power supply, connectors, and cables with appropriate ratings for voltage, current, etc. Make sure that the voltage at the connector of this device is within the specified power voltage range.
- Take care not to wire incorrectly. Wrong wiring may cause device failure.
- This device does not function for up to 10 s after the power has been turned on. Great care should be taken when the relay output from this device is used as an interlock signal.
- Do not connect multiple Smart Loader cables connected to multiple device units to one personal computer at the same time. The current coming from other circuits might cause an output value indication error to occur.
- Do not use excessive force to push in or pull out cables. Otherwise device failure may result.

■ WIRING

● Connector pin assignments (D-sub 15-pin)

Pin No.	Name
1	Event relay 3 (COM)
2	Output (+)
3	Power supply (COM)*1 *2
4	Event relay 2 (COM)
5	Power supply (-)*1
6	Event relay 3 (NO)
7	Power supply (+)
8	Event relay 3 (NC)
9	Event relay 2 (NO)
10	Event relay 2 (NC)
11	Event relay 1 (COM)
12	Output (COM)*2
13	Event relay 1 (NO)
14	Event relay 1 (NC)
15	FG*3

● Example of external connection

- ±15 V DC (dual power supplies)

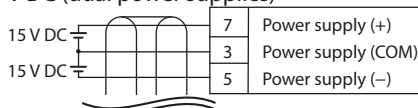

- 24 V DC (single power supply)

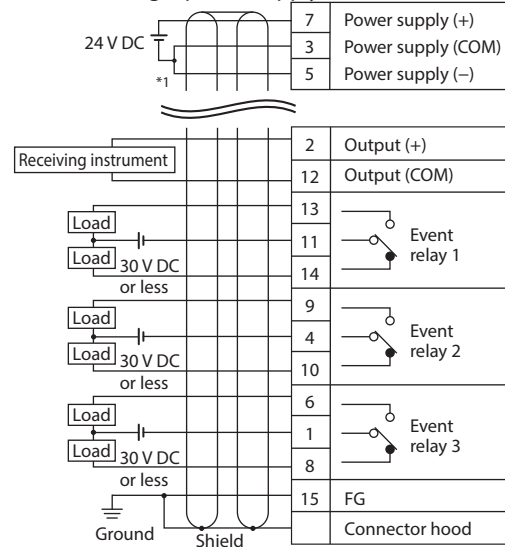

- *1 If using a single 24 V DC input power supply, connect the power COM to the power "-".
- *2 The power COM and output COM are internally connected. If using a single 24 V DC input power supply, do not connect the power COM and output COM together. Also, take care to avoid any wrong wiring that may cause a short circuit in other equipment. If the wiring is connected incorrectly, current from the power supply will also flow through the output line, and the voltage drop from wiring resistance may cause a measurement error.
- *3 The FG is electrically continuous with the case, but is insulated from the power COM, output COM, and other terminals.



Note

- Event relay connection

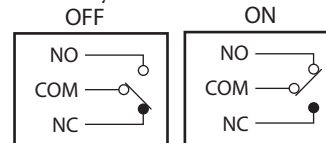

When the power supply is turned off the event relay is turned off.

ADJUSTMENT AND START-UP

⚠ WARNING



The surface of this device is very hot while the power is ON and for a while after the power has been turned OFF. To avoid a burn, do not touch it during this period. (Self-heating models)

⚠ CAUTION



Do not block the ventilation holes. Doing so might cause fire or device failure.



Use the relays in this device within the operating ranges recommended in the specifications. Otherwise, fire or device failure may result. If there is a possibility that the device will be used in conditions that are outside the range of the specifications, take appropriate countermeasures.

■ Turning the power ON

Use this device after warm-up is complete, 1 hour or more after turning the power ON.

- If warm-up is not finished, the status LED is orange.
- When warm-up is complete, the status LED turns green.



Handling Precautions

- This device does not satisfy specifications for accuracy during the warm-up period after the power has been turned ON, before the self-heating temperature has stabilized. Always use this device after warm-up is complete.
- If any problem with the operating environment (power voltage, ambient temperature, etc.) is detected during the self-diagnosis of this device, the status LED starts to flash red. If this occurs, turn off the power and check the instrumentation status.

- If any internal error is detected during the self-diagnosis of this device, the status LED lights up red. If this occurs, turn off the power and contact the azbil Group.
- Do not apply a pressure to this device that exceeds the marginal pressure. Doing so might cause device failure.
- Take appropriate measures so that no contaminant enters this device. Otherwise a measurement error or device failure might occur.
- Take appropriate measures so that no foreign matter flows into this device. If it does, measurement error or device failure could result.
- For the pressure range characterized by molecular flow and intermediate flow, if the self-heating temperature of this device is different from the temperature inside the chamber to be measured, a minute pressure difference occurs due to thermal transpiration. To achieve especially accurate measurement, this must be taken into account. Factory calibration of this device assumes that no temperature difference exists. For details, refer to T. Takaishi and Y. Sensui, Trans. Faraday Soc. 59 (1963) 2503.
- Do not press the zero point adjustment buttons with excessive force. Doing so may damage the device.

■ Zero point adjustment

- Adjust the zero point before using this device. Zero point adjustment should be done with a sufficient vacuum (1/20,000 or less of the selected pressure range span), 1 hour or longer after the power was turned on, after warm-up is complete.
- For accurate measurement, periodic adjustment of the zero point is recommended.
- When the zero point is adjusted, the bias adjustment values inside the device are updated. The updated bias adjustment value is added to the pressure measurement, which is then output. The factory setting for the bias adjustment value is 0.

Adjust the zero point in either of the two ways described below.

● Auto zero point adjustment

- (1) Apply a vacuum with a pressure of 1/20,000 or less of the selected pressure range.
- (2) Keep the auto zero point adjustment button pressed for 3 s. After zero point adjustment:
 - If the bias adjustment value is within ± 5 %FS, the status LED flashes green three times.
 - If the bias adjustment value is between ± 5 and ± 20 %FS, the status LED flashes orange three times.

! Handling Precautions

- Auto zero point adjustment cannot be done in the following cases even if the button is pressed:
 - Before warm-up is complete.
 - If an error occurs.
 - If the required bias adjustment value is beyond ± 20 %FS.
- In these cases, the status LED flashes alternately red and orange three times.

● Manual zero point adjustment

- (1) Apply a vacuum with a pressure of 1/20,000 or less of the selected pressure range.
- (2) The 0-10 V output voltage changes when the up/down zero adjustment button is pressed. Adjust the output voltage to 0.

When the button is pressed, the speed at which the 0-10 V value changes depends on how long the button is pressed. Keep it pressed for a long time to do a quick rough adjustment. Afterwards, press it repeatedly for a short time to make fine adjustments.

- During adjustment using the up/down zero point button:
 - If the bias adjustment value is within ± 5 %FS, the status LED flashes green.
 - If the bias adjustment value is between ± 5 and ± 20 %FS, the status LED flashes orange.
 - The status LED stops flashing about 3 s after the up/down zero point adjustment button is released, and the bias adjustment value is then set.
- Zero adjustment is restricted to the range in which the bias adjustment value is ± 20 %FS. If the bias adjustment value reaches ± 20 %FS as the up/down zero point adjustment button is pressed, the status LED flashes red.

! Handling Precautions

- Manual zero point adjustment cannot be done in the following cases even if the button is pressed:
 - Before warm-up is complete.
 - If an error occurs.
 - If the pressure value exceeds the measurement range.

In these cases, the status LED flashes alternately red and orange three times.

● Resetting of bias adjustment value

To reset the bias adjustment value to its factory setting, keep the auto zero point adjustment button pressed for 30 s or longer. The zero point is adjusted after 3 s, and the bias value is reset after 30 s. The status LED then flashes alternately green and orange three times.

■ Status LED display operation

Status LED	Status
Lit green	Normal operation status (after warm-up)
Lit orange	Warm-up in progress (device temperature is not yet stable)
Lit red	Abnormal status (a problem with the device)
Flashing red (0.3 s, 0.3 s)	Abnormal status (operating environment problem, such as excessive ambient temperature or wrong power voltage)
3 green flashes (0.3 s, 0.3 s)	Automatic zero point adjustment (by pressing the auto zero point adjustment button) is complete, and the bias adjustment value is within ± 5 %FS.
3 orange flashes (0.3 s, 0.3 s)	Automatic zero point adjustment (by pressing the auto zero point adjustment button) is complete. The bias adjustment value is between ± 5 and ± 20 %FS.
Flashing green (0.1 s, 0.1 s)	The zero point is being adjusted with the up/down zero point adjustment buttons. The bias adjustment value is within ± 5 %FS.
Flashing orange (0.1 s, 0.1 s)	The zero point is being adjusted with the up/down zero point adjustment buttons. The bias adjustment value is between ± 5 and ± 20 %FS.
Flashing red (0.1 s, 0.1 s)	During zero point adjustment with the up/down zero point adjustment buttons, the bias adjustment value reached the maximum adjustable range of ± 20 %FS.
Lit alternately red and orange 3 times (0.3 s, 0.3 s)	The auto or up/down zero adjustment button was pressed but conditions did not permit zero adjustment.
Lit alternately green and orange 3 times (0.3 s, 0.3 s)	The bias adjustment value has been reset.
Alternating green and orange with occasional red (1.9 s, 0.1 s)	The event relay is latched.*1
Lit alternately green and red. (0.3 s, 0.3 s)	Output is manually controlled.*2
Off	The device is not powered up.

*1 Latching of the event relay must be set up with the Smart Loader (sold separately).

*2 Output can be manually controlled with the Smart Loader (sold separately).

MAINTENANCE AND TROUBLESHOOTING

■ Maintenance

● Maintenance and inspection

- Check that the status LED is green during operation.
- Check periodically that there are no leaks in the piping.
- Adjust the zero point periodically.

● Cleaning

- Use a soft dry cloth.
- Do not use any organic solvent such as paint thinner or benzene.

● Part replacement

Do not disassemble the device or attempt to replace any of its parts.

■ Alarm displays and corrective actions

The following table shows the alarm displays and corrective actions to take if there is a problem:

Status LED	Status	Possible Causes	Action
Flashing red	Alarm	<ul style="list-style-type: none"> • Temperature of electronic circuits • Temperature of sensor head • Heater temperature error • Self-heating control error • Wrong supply power voltage 	Turn off the power and check the power voltage, ambient temperature, and other operating conditions.
Lit red	Failure	<ul style="list-style-type: none"> • Heater wire break • Memory failure • Electronic circuit failure 	Turn off the power and contact the azbil Group or your dealer, agent, or salesperson. The device needs to be repaired by Azbil Corporation.

Important notice: If you send this device to Azbil Corporation for repair, fill out the Safety Sheet on page 8 and include it with the device.

Troubleshooting

Symptom	Action
Status LED does not light up	Check that the wiring is connected correctly. Check that the power voltage and polarity are correct.
Output value fluctuates	Check that the wiring is connected correctly. Adjust the zero point.

DISPOSAL

When disposing of this device, dispose of it appropriately as industrial waste in accordance with local regulations.

SPECIFICATIONS

Items	Specifications		
Pressure range	As specified in the model selection table.		
Self-heating temperature			
Accuracy	Accuracy	Pressure range	Self-heating temperature range
	0.25 % Reading	10 Pa to 33.331 Pa	45 °C
	0.5 % Reading		80 °C or more
	0.25 % Reading	100 Pa to 133.32 kPa	No self-heating or less than 160 °C
	0.5 % Reading		160 °C or more
Temperature coefficients zero	Temperature coefficients zero	Pressure range	Self-heating temperature range
	0.008 %FS/°C	10 Pa to 33.331 Pa	45 °C
	0.016 %FS/°C		80 °C or more
	0.008 %FS/°C	100 Pa to 133.32 Pa	No self-heating or less than 160 °C
	0.016 %FS/°C		160 °C or more
	0.004 %FS/°C	200 Pa to 133.32 kPa	No self-heating or less than 160 °C
	0.008 %FS/°C		160 °C or more
Temperature coefficients span	0.02 % rdg./°C		
Resolution	1/10000 FS		
Operating temperature range	Model SPG5 _/SPG7 _	Models whose self-heating temperature is 80 °C or more: 10 to 45 °C (Cooling air with a velocity of 0.5 m/s or more is required at 35 °C or more.) Models whose self-heating temperature is 45 °C: 10 to 40 °C (Cooling air with a velocity of 0.5 m/s or more is required at 35 °C or more.) Non-self-heating models: 0 to 60 °C	
	Model SPG6 _	10 to 65 °C (when mounted vertically), 10 to 70 °C (when mounted horizontally) (Cooling air with a velocity of 0.5 m/s or more is required at 45 °C or more.)	
	Model SPG8 _	10 to 55 °C (when mounted vertically), 10 to 60 °C (when mounted horizontally) (Cool air flow of at least 0.5 m/s is needed at 35 °C and higher for vertically mounted devices, or at 45 °C and higher for horizontally mounted devices.)	
Operating humidity range	10 to 90 %RH (without condensation)		
Storage temperature and humidity range	-20 to +80 °C, 10 to 95 %RH (without condensation)		
Response time	Model SPG_A: 35 ms Model SPG_B: 50 ms (models with pressure range of 1000 Pa or more) 60 ms (models with pressure range of less than 1000 Pa) Model SPG_C: 40 ms (Models with pressure range of 100 Pa or more) 50 ms (Models with pressure range of less than 100 Pa)		
Gas-contacting materials	Sapphire, DSALLOY (equivalent to Inconel), SUS316L		
Internal capacity	4.6 cm ³ : 1/2 inch gauge port fitting type 7 cm ³ : 8 VCR fitting type 7 cm ³ : NW16 fitting type 5 cm ³ : IDF 1.5S 2S ferrule fitting type		
Allowable pressure*1	Model SPG5 _/SPG6 _/SPG8 _ : 200 kPa abs (Models with pressure range of 100 kPa or more) 110 kPa abs (Models with pressure range of less than 100 kPa) Model SPG7 _ : 300 kPa abs		
Marginal pressure*2	300 kPa abs		

Items	Specifications				
Burst pressure*3	700 kPa abs				
Input power supply	Voltage range: ±15 V DC ±10 % (dual power supplies) or 24 V DC ±10 % (single power supply) Allowable ripple voltage: 0.5 Vp-p max.				
Power consumption/ power current*4 *5	Self-heating temperature	Power consumption		Power current	
		During normal operation	During warm-up	±15 V DC supply	24 V DC supply
	non-self-heating model	3 W max.	3 W max.	0.12 A max.	0.14 A max.
	45 °C	5 W max.	8 W max.	0.3 A max.	0.4 A max.
	100 °C	9 W max.	13 W max.	0.5 A max.	0.7 A max.
	125 °C	10 W max.	14 W max.	0.6 A max.	0.7 A max.
	150 °C	12 W max.	16 W max.	0.6 A max.	0.8 A max.
	160 °C	13 W max.	17 W max.	0.7 A max.	0.8 A max.
	180 °C	15 W max.	19 W max.	0.8 A max.	0.9 A max.
	200 °C	16 W max.	23 W max.	0.9 A max.	1.1 A max.
	230 °C	23 W max.	32 W max.	1.2 A max.	1.5 A max.
260 °C	26 W max.	36 W max.	1.4 A max.	1.7 A max.	
280 °C	28 W max.	39 W max.	1.5 A max.	1.9 A max.	
Output signal	Signal voltage: 0 to 10 V DC Allowable load resistance: 10 kΩ min. Measurement output range: -0.5 to +11 V DC*6 Output during warm-up or abnormal status: Output depends on the measured pressure*7				
I/O connector	D-sub 15-pin connector (male), retaining screw #4-40UNC				
Mass	450 g: 1/2 inch gauge port fitting type 520 g: 8 VCR fitting type 470 g: NW16 fitting type 580 g: IDF 1.5S ferrule fitting type 650 g: IDF 2S ferrule fitting type				
Warm up time	30 min (nominal), 1 h max.				
Zero point adjustable range	±20 %FS				
Fitting	As specified in the model selection table.				
Leak rate	1×10 ⁻¹⁰ Pa·m ³ /s or less: Models without ferrule connection 1×10 ⁻⁹ Pa·m ³ /s or less: Models with ferrule connection				
Mounting angle	Unrestricted*8				
Allowable cable length	10 m max.				
Event relay ratings	Number of relays: 3 Contact form: 1c (both NO and NC contacts) Maximum load: 1 A-30 V DC resistance load Minimum load: 10 μA 10 mV DC*10 Mechanical service life: 50 million cycles min. Electrical service life: 100 thousand cycles min. (with 1 A, 30 V DC resistance load) Certifications: UL, CSA				
Event relay functions default setting*9	Event relay 1: Pressure low limit (direct action) Setting: value is assigned by model No. Operating hysteresis: 0.5 %FS Always operates together with pressure during warm-up or abnormal status.				
	Event relay 2: Pressure low limit (direct action) Setting: value is assigned by model No. Operating hysteresis: 0.5 %FS Always operates together with pressure during warm-up or abnormal status.				
	Event relay 3: ON if warm-up complete and OFF if warm-up not complete or if status abnormal				
	Event relay LED: Green when event relay ON, off when event relay OFF				
Standards compliance	CE marked (EN 61326-1, EN61326-2-3) (For Use in Industrial Locations) KC marking*11				

Items	Specifications
Accessories (sold separately)	Model SLP-SP5 Smart Loader Package

- *1 At the allowable pressure, the performance level of this unit can be maintained. However, if the device is repeatedly subjected to the allowable pressure, adjust the zero point periodically.
- *2 At the marginal pressure, this unit will continue to function. If the device is subjected to the marginal pressure, readjust the zero point. If more accurate measurement is required, return the unit to Azbil Corporation for calibration. If the marginal pressure is exceeded, the proper operation of this unit can no longer be guaranteed. In this case, replace the unit with a new one.
- *3 The burst pressure is the pressure at which this device will break. To avoid an accident, never apply pressure equaling or exceeding the burst pressure.
- *4 Use an appropriate power supply with a rated current exceeding the max. power current value.
- *5 PID control is used to regulate the temperature and keep the rate of current supplied to the heater as constant as possible. Additionally, the maximum power current is varied depending on the power voltage, so that power consumption remains constant even during warm-up, irrespective of the power voltage. (Self-heating models)
- *6 Since a negative voltage is generated inside this unit, a negative voltage output is available even with only a single-output power supply.
- *7 The conditions and voltage can be changed using the Smart Loader.
- *8 This unit was calibrated at the factory in a vertical position. Shift of the zero point may have occurred, depending on the mounting angle. In such a case, accuracy can be recovered by adjusting the zero point after installation. Vertical installation is recommended to prevent contaminants from accumulating on the sensor unit.
- *9 The event relay functions can be changed using the Smart Loader.
- *10 The minimum load specification is an estimate of the minimum load at which the event relay is able to open and close. This value can vary depending on the frequency of operation, environmental conditions, and the expected reliability level. Before actual use, a check of the relay's operation using the actual load is recommended.
- *11

CP-SP-1400E-1

이 기기는 업무용(A급) 전자파 적합기기로서 판매자 또는 사용자는 이점을 주의하시기 바라며, 가정외의 지역에서 사용하는 것을 목적으로 합니다.

KCC-REM-A2B-A067

基于SJ/T11364-2014「电子电气产品有害物质限制使用标识要求」的表示式样
 产品中有害物质的名称及含量

部件名称	有害物质					
	铅 (Pb)	汞 (Hg)	镉 (Cd)	六价铬 (Cr(VI))	多溴联苯 (PBB)	多溴二苯醚 (PBDE)
电路板组件	×	○	○	○	○	○
温度传感器组件	×	○	○	○	○	○
加热器组件	×	○	○	○	○	○

本表格依据SJ/T 11364 的规定编制。
 ○: 表示该有害物质在该部件所有均质材料中的含量均在GB/T 26572规定的限量要求以下。
 ×: 表示该有害物质至少在该部件的某一均质材料中的含量超出GB/T 26572规定的限量要求。

Export Control

Export Control & Compliance

Products in this Specification or User's Manual ("Products") are subject to laws and regulations of Japan and any other applicable jurisdiction with respect to export of the Products.

In order for Azbil Corporation to apply for the appropriate export license in Japan, your cooperation may be asked for the provision of details on end user, end use and any other related information.

Further, in case of export from Japan by an exporter ("Exporter") or re-export from any other countries, you are required to obtain the appropriate export license from the government of Japan or such other countries.

In addition, in case of re-export of the Products, any re-exporter is required to obtain the prior consent of the Exporter.

External Dimensions

● Model SPG5 /SPG7

Unit: mm

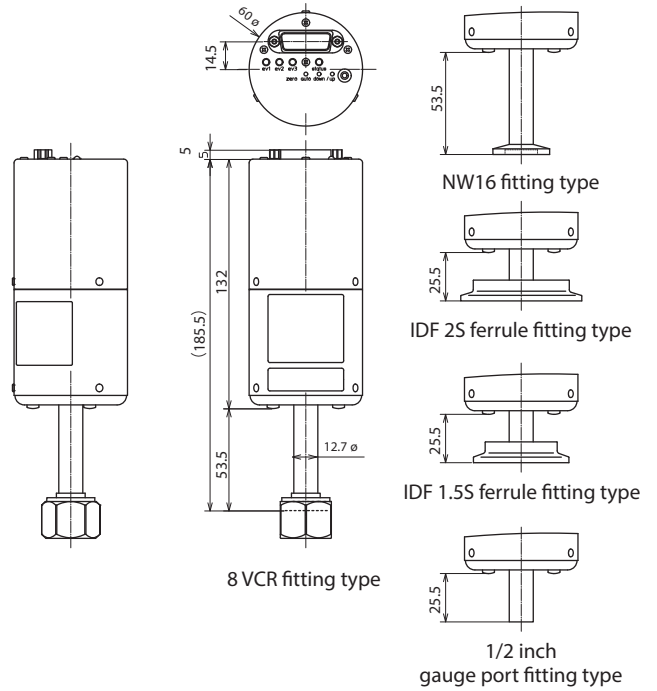

● Model SPG6

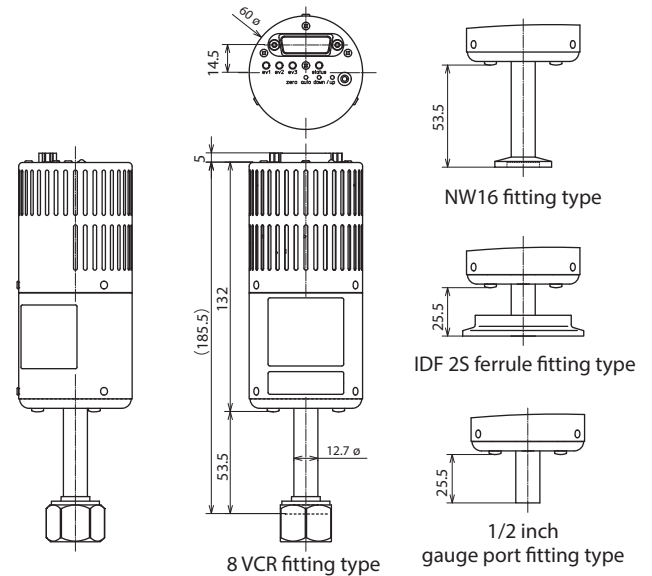

● Model SPG8

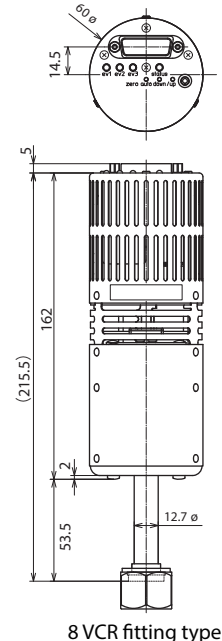

IMPORTANT NOTE: If it is necessary to send this device back to Azbil Corporation for repair, photocopy the following Safety Sheet, fill in the required items, and return the sheet with the unit.

The Safety Sheet is intended to ensure that the customer's product is safe for repair personnel and for the environment.

Without this sheet, Azbil Corporation cannot start repair work. Please note that if the sheet is incomplete, Azbil Corporation may request the customer to resubmit it.

Safety Sheet

To use, photocopy this page.

To: Azbil Corporation

Statement by the End User (required prior to repair work)

I attest to the safety of this device based on the following evidence (check the applicable box):

- Hazardous substances have been purged or flushed completely.
- This device has been used only with clean, dry inert gas such as air, N₂, Ar, and He.

Model number: _____

Date code: _____

Serial number: _____

Name: _____

Date: _____

Department: _____

Company: _____

Phone: _____

Approved by (supervisor): _____

Comments or supplementary information:

(Do not fill in - for Azbil Corporation internal use only) Dealer/Agent/Salesperson Information

Date: _____

Name: _____

Company: _____

Department: _____

Phone: _____

Date: _____

Name: _____

Company: _____

Department: _____

Phone: _____

Important Notice

Depending upon the degree of contamination of the device, Azbil Corporation reserves the right to refuse repair.

Handling of personal information

We will use your personal information provided to us by this sheet only for the purposes of providing after-sales services to you.

azbil

Specifications are subject to change without notice. (11)

Azbil Corporation

Advanced Automation Company

1-12-2 Kawana, Fujisawa
Kanagawa 251-8522 Japan

URL: <https://www.azbil.com>

© 2015–2019 Azbil Corporation. All Rights Reserved.

1st edition: July 2015 (F)
4th edition: Sep. 2019 (V)