

Hybrid Recorder Model SR200 (Pen Type)

Instruction Manual General



Thank you for purchasing your Azbil Corporation product.

This manual contains information for ensuring the safe and correct use of the product.

Those designing or maintaining equipment that uses this product should first read and understand this manual. This manual contains information not only for installation, but also for maintenance, troubleshooting, etc. Be sure to keep it nearby for handy reference.

Azbil Corporation

Table of contents

1. Introduction	1
2. For Safe Use	4
2-1. Preconditions for Use	4
2-2. Symbol Mark	4
2-3. Label	4
2-4. Important Explanation	5
3. Model Code List	6
4. Mounting and Wiring	7
4-1. External Dimensions	7
4-2. Mounting	7
4-3. Wiring	9
5. Part Names	27
5-1. Front Section of Internal Unit	27
5-2. Operation/Set Keys	28
6. Operation	29
6-1. Preparation for Operation	29
6-2. Basic Operation	32
6-3. Operation	37
7. Factory Default Settings	40
7-1. List of Factory Default Settings	40
8. Setting Method	41
8-1. Basic Rules	41
8-2. Input Type Settings "Range"	43
8-3. Alarm Settings "Alarm"	47
8-4. Calculation Settings "Calc"	54
8-5. Formula Settings "Formula"	58
8-6. Broken Line Approximation Table Settings "Seg.Tbl"	65
8-7. Chart Speed Settings "Chart"	66
8-8. Time axis synchronization "POC"	67
8-9. Subtract Printing Settings "Sub Prt"	69
8-10. Periodic (Data Interval) Data Printing Settings "DataInt"	71
8-11. Periodic (Specified Time) Data Printing Settings "PrtTime"	72
8-12. List Printing Settings "ListPrt"	73
8-13. Message Printing 1 Settings "MsgPrt1"	74
8-14. Message Printing 2 Settings "MsgPrt2"	75
8-15. Recording Format Settings "PrtForm"	76
8-16. Auto Range Settings "A.Range"	77
8-17. Compressed/Expanded Printing Settings "Cmp&Exp"	79
8-18. Zone Printing Settings "ZonePrt"	81
8-19. SD Card "SD CARD"	83
8-20. USB Engineering Port Settings "USB"	90
8-21. Calendar Timer Settings "Timer"	91
8-22. Fail Output Settings "FailOut"	92
8-23. Display Settings "Display"	94
8-24. Measured Value Display Order Settings "D.Order"	95
8-25. Date and Time Settings "Date"	96
8-26. System Settings "System"	97
8-27. System Information Display "SysInfo"	99
8-28. Soft Dip Switch Settings "SoftDip"	100

9. Adjustment	102
9-1. Trace Printing Position Adjustment "Rec Adj"	102
9-2. Recording Posotion (time) Adjustment	104
9-3. Input Adjustment "Inp Adj"	105
9-4. Input Shift Adjustment.....	106
9-5. Wiring and Environment for Input Adjustment	107
10. Engineering Port (Mini-USB Terminal)	108
11. Troubleshooting	109
11-1. Problems and Remedies	109
11-2. Abnormal Measured Value	110
12. Inspection and Maintenance	111
12-1. Routine Inspection.....	111
12-2. Consumable Parts and Replacement Guideline	111
12-3. Battery removal method for the purpose of disposa	112
13. Option	114
13-1. External Operation Settings "Dig Inp"	114
13-2. Operation Recording Settings "Ope.Rec".....	117
13-3. COM Port Settings "COM1" and "COM2"	118
13-4. IP Address etc... Settings "Ether"	119
13-5. SNTP Settings "SNTP"	120
13-6. E-mail Settings "E-mail"	121
14. Specifications	124

1. Introduction

Thank you for purchasing SR200 (Pen Type) with 180mm recording width.

This industrial use instrument records input signals to the chart paper and stores data into the SD card.

Mount this instrument on the indoor instrumentation panel etc. and record signals of temperature sensor, pressure gauge, hygrometer and flow meter.

Reading signals of the recorder are thermocouple, resistance thermometer, DCmV and DCV.

Make sure to read this instruction manual in advance to understand this unit well and prevent troubles from occurring. This manual is a "General" Instruction manual. For specifications with communications, read the "Communications" instruction manual separately.

Request

- To the persons doing instrumentation, installation, and sales -

Make sure to provide this instruction manual to the person who uses the unit.

- To the users of this unit -

Store this instruction manual with care until you scrap the unit.

Also, write down the parameter contents set in the product and keep it for your record.

Product warranty period

This product is warranted for one year from the date of delivery. If it is damaged during the warranty period, when used normally based on the cautions in the instruction manual, labels, and markings attached to the product, etc., it will be repaired without any charge (only in Japan). In the case, we are sorry to trouble you, but please contact your dealer or nearest our sales office.

However, in cases of the followings, it will be repaired at your expense even during warranty period.

1. Failure caused by improper use or connection, or invalid repair or modification.
2. Failure caused by fire, earthquake, wind or flood, thunderbolt, or other extraordinary natural phenomena, or pollution, salt, harmful gas, abnormal voltage, or use of unspecified power.
3. Replacement of parts or accessories that have reached the end of their life.

Furthermore, the term 'warranty' in this sense covers only an Azbil's product itself. Therefore, we are not responsible for compensation for whatever the damage that is triggered by failure of our product.

Notice

1. No part of this manual can be reproduced or copied in any form without permission.
2. The contents of this manual may be altered without prior notice.
3. This manual has been documented by making assurance doubly sure. However, if any question arises or if any error, an omission, or other deficiencies are found, please contact your nearest our sales office.
4. Azbil is not responsible for any operation results of this software.

Trademark

1. Microsoft, Windows, Windows 7, Windows 8.1, Windows 10, and NET Framework are trademarks of Microsoft Corporation and the related company.
2. SD Memory Card is the trademark of Panasonic Corporation, SanDisk Corporation in USA, and TOSHIBA CORPORATION.
3. Other described company names and product names are trademarks and registered products of the respective companies.
4. Please note that the marks "TM" and "®" are omitted throughout this manual.

Warning

Perchlorate Material

This instrument uses battery with Perchlorate Material.

Special handling may apply, see

http://www.dtsc.ca.gov/hazardous_waste/perchlorate

■ Before use

Make sure to check the following before use after unpacking the unit. If you have any question, please contact your dealer or our nearest office.

1. Exterior check

Check that the appearance of the product has no damage.

2. Model code check

Check that the model code of the purchased product is correct.

◆ Model code label and application place

The label as follows is attached on the upper surface of the product case and the chassis.

Model code	→	SR-□□□□□□□□□□ CHINO
Serial number	→	Y7-□□□□□□□□□□ YYYYMMDD
		MADE IN JAPAN

"YYYYMMDD" indicates the date of manufacture.

3. Accessories check

Check the following accessories attached to the product.

Item	Q'ty	Remarks
Instruction manual	1	CD-R
Instruction manual [Wiring/Installation]	1	Booklet
Bracket	1 set	For panel mounting
Terminal screw	5	M3.5, for input terminal (spares for missing)
Chart paper	1	81407861-001
Cartridge pen (Analog pen)	1 each	Red (1 st pen), Green (2 nd pen) Blue (3 rd pen), Brown (4 th pen)
Plotter pen (Digital pen)	1	Purple

In addition, if accessories are purchased additionally, those products may be attached.

Request

1. Do not drop the product while take it out of the box
2. When transporting the unit, pack in the dedicated package box, and put the box in an outer case with a bed of cushion.
With the consideration to the case above, it is recommended that the dedicated package box for the unit is stored.
3. When the unit is removed from the panel and not used for a long time, put it in the dedicated package box, and store it in a place with normal ambient temperature and less dust.

4. About attached chart paper

For the unit, the chart paper 81407861-001 (1 book) is available and attached. For the case that the chart paper is to be specified, various scales are available as follows.

Item	Item number	Printed scale (The following numbers are printed.)	Remarks
Folding standard chart 100 divisions	81407861-001	0,20,40,60,80,100	10 books 20m
Folding standard chart 100 divisions	81425049-001	0,10,20,30,40,50 0,20,40,60,80,100 0,40,80,120,160,200 The above 3 patterns are printed.	10 books 20m
Folding standard chart 120 divisions	81425049-002	0,10,20,30,40,50,60 0,200,400,600,800,1000,1200 The above 2 patterns are printed.	10 books 20m
Folding chart 140 divisions	81425049-003	0,2,4,6,8,10,12,14 0,10,20,30,40,50,60,70 The above 2 patterns are printed.	10 books 20m
Folding chart 80 divisions	81425049-004	0,20,40,60,80 0,100,200,300,400 0,400,800,1200,1600 The above 3 patterns are printed.	10 books 20m
Folding chart 150 divisions	81425049-005	0,50,100,150	10 books 20m
Clean paper chart 100 divisions	81407937-001	0,20,40,60,80,100	10 books 16m

- * The chart paper has the same printed linear scale as the standard scale.
Therefore, it can be shared in regardless of input types (thermocouple, resistance thermometer, or others).
- * When using recording paper other than the genuine chart, operation is not guaranteed.

5. Restriction of digital recording/printing function

- (1) When the chart speed is set to 150mm/H or more, printing function for other than time line, power-on printing, data printing, list printing and setting change mark is disabled.
- (2) Printing is formed with dots of one pin. Therefore, if the power is turned off while characters are being formed, they cannot be formed correctly. This is not abnormal.

6. Service parts

For the unit, service parts are available as follows.

Item	Item number	Remarks
Cartridge pen (Analog pen) Red	SR-932CP000R	3 pieces
Cartridge pen (Analog pen) Green	SR-932CP000G	3 pieces
Cartridge pen (Analog pen) Blue	SR-932CP000B	3 pieces
Cartridge pen (Analog pen) Brown	SR-932CP000C	3 pieces
Plotter pen (Digital pen) Purple	81446296-001	3 pieces
SD card	512MB	SR-911SD0512
	1GB	SR-911SD1000
	2GB	SR-911SD2000
250Ω resistor	Accuracy ±0.02%	81401325
	Accuracy ±0.05%	81446642-001

2. For Safe Use

If the unit is used in a manner not specified by the manufacturer, the protection provided by the unit may be impaired. For safe use of the unit, please read and understand the following cautions.

2-1. Preconditions for Use

The unit is a component type general product to be used mounted on an indoor instrumentation panel. Avoid using under other conditions.



Use after the system safety is implemented such as fail-safe design and periodical inspection on the final product side.

Also, for wiring/adjustment/operation of the unit, ask professionals with instrumentation knowledge to perform.

Furthermore, the person who actually uses the unit is required to read this instruction manual to fully understand various cautions and basic operation.



2-2. Symbol Mark

This instruction manual includes the following symbol marks. Make sure to fully understand the meaning of them.

Symbol mark	Meaning
 Warning	Cautions are explained to avoid causes for death or serious injuries of users.
 Caution	Cautions are explained to avoid causes for slight injuries of users or damages of the unit or peripheral devices.

2-3. Label

For safe use of the unit, the following labels are used.

Label	"Name" and place	Meaning
	"Alert symbol mark" Various terminals (back side)	Indicates the location which should refer to the manual in order to prevent an electric shock and injury.
	"Protective conductor terminal" Right side of power terminal (back side)	Terminal to be grounded to avoid electric shock
100 to 240V AC* 50/60Hz, 37VA	"Power source specification" Power conductor terminals	Specification of power (voltage range, frequency, and power consumption) used for the unit

*For one pen type.

2-4. Important Explanation



Warning

To avoid severe accidents, make sure to read and understand the following.

1. Switch and overcurrent protection device

This unit is not provided with a replaceable overcurrent protective device. Prepare a switch and an overcurrent protective device for the power supply (circuit breakers, circuit protectors or the like) within 3m of this unit in a location where the operator can access easily. Use a switch and an overcurrent protective device conforming to IEC947-1 and IEC947-3.

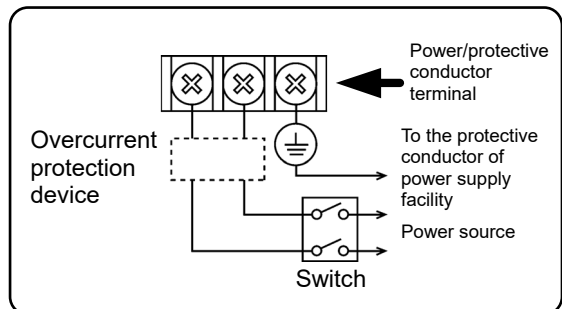

2. Be sure to ground this instrument

To avoid electric shock, before turning the power on, connect the protective conductor terminal of this recorder to the protective conductor of the power supply equipment, and do not remove it during use.

3. Before turning on the power supply

For safety, first check that the power source is within the range indicated on the power label, and then turn on the external power switch.

4. Avoid repair and modification

Avoid repair and modification with parts replacement by persons other than service personnel authorized by CHINO. Not only damage or malfunction of this recorder may occur, but also dangers such as electric shock may occur. In addition, the inner unit does not have to be pulled out in the normal use.

5. Use the unit following the instruction manual

For safe use, use the unit following the instruction manual. Please note that CHINO does not have any responsibilities for any claims for failures or damages occurred with abuse or misuse of this recorder.

6. Installing the safety device

Regarding the use of devices that anticipates a big loss due to failure of this unit, always install a safety device for preventing these losses and implement fail safe design in the final instrumentation. This product is designed as a general-purpose product for general industrial products. It is not intended for use in human-life and property related applications such as nuclear and radiation related equipment, medical equipment, aerospace equipment, railroad, and marine transportation equipment. To use this product for equipment that requires high quality and safety that affects human-life and property, design and install the protection and safety circuits to ensure safety at your own responsibility.

7. Turn off the power supply if abnormality occurs

Turn off the power supply immediately and contact your local CHINO's sales office if any abnormal odor, noise or any smoke occurs, or if this unit becomes high temperature that is too hot to be touched.

8. Do not put hands in this product

Do not put your hands or tools inside of this product. It may cause electric shock or injuries. There is no operation such as pulling out an inner unit or using tools when using this product.

9. Do not look at light directly

Do not look at the chart illumination directly.

Reference Fuse in power unit

For safety, the fuse below is included in the power unit of the unit. It cannot be replaced.

Manufacturer: Daito Communication Apparatus Co., Ltd
Model: SBL32

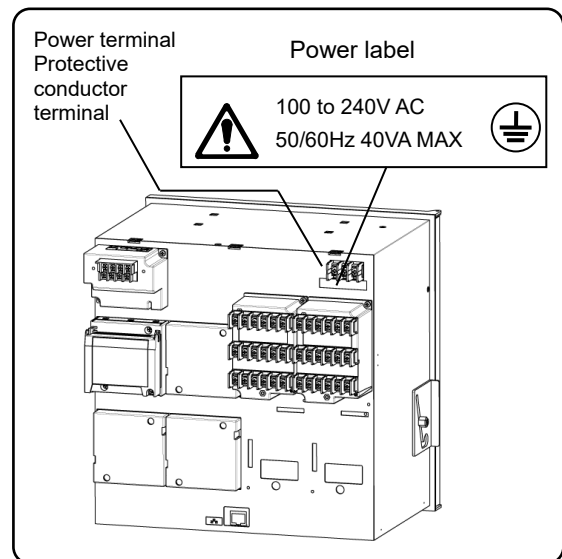

3. Model Code List

SR-2□□□□□NNN

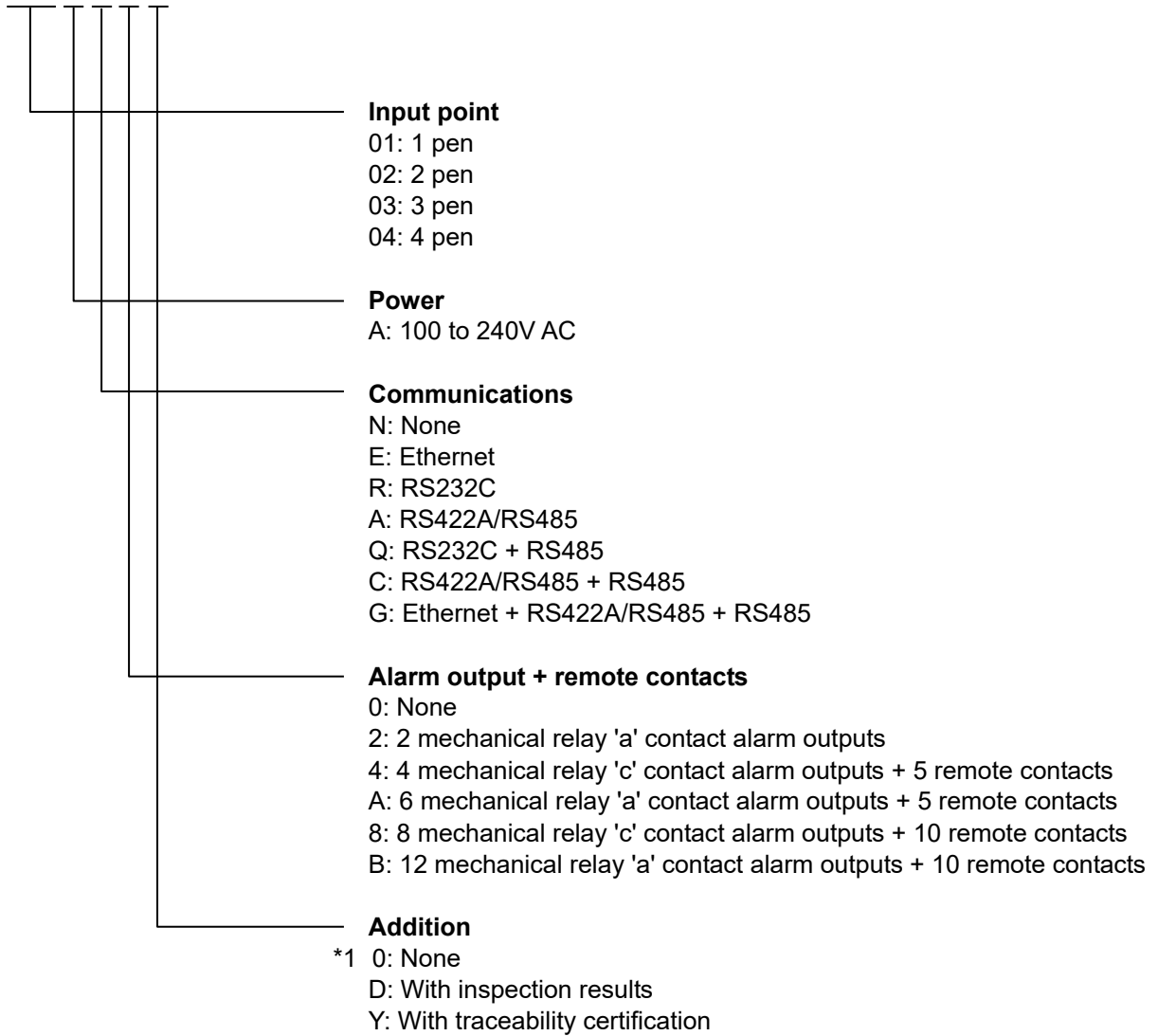

*1 Additional tropical treatment products and sulfurization prevention products are available. Please contact us for these additions as there is a limit to some specifications.

4. Mounting and Wiring

4-1. External Dimensions

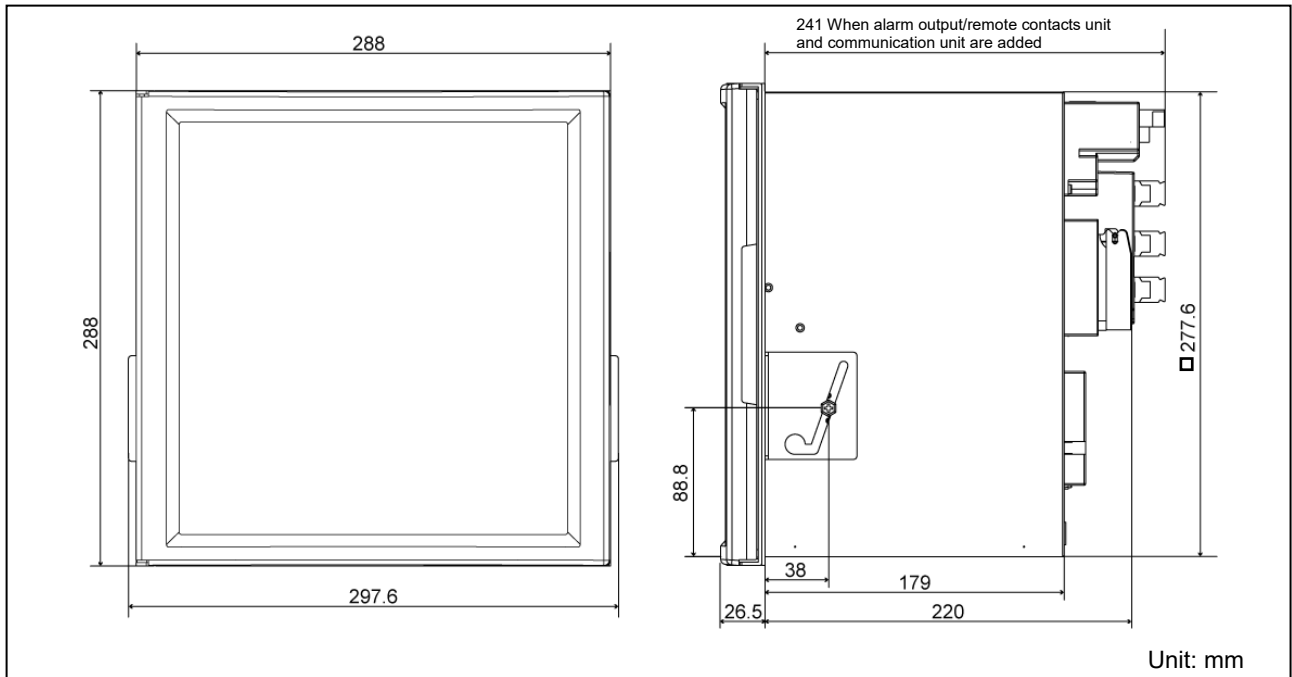

4-2. Mounting

 <p>Caution</p>	<p>(1) Use the recorder mounting on an indoor installed instrumentation panel.</p> <p>(2) Brackets can be attached to a panel of steel with thickness of 2 to 6mm or equivalent strength. Select thickness of a panel considering weight and depth of the unit with panel formation for actual use.</p> <p>(3) When mounting the recorder on the panel, mount it according to the instruction manual for preventing injury.</p>
---	---

1. Panel cutout and mounting method

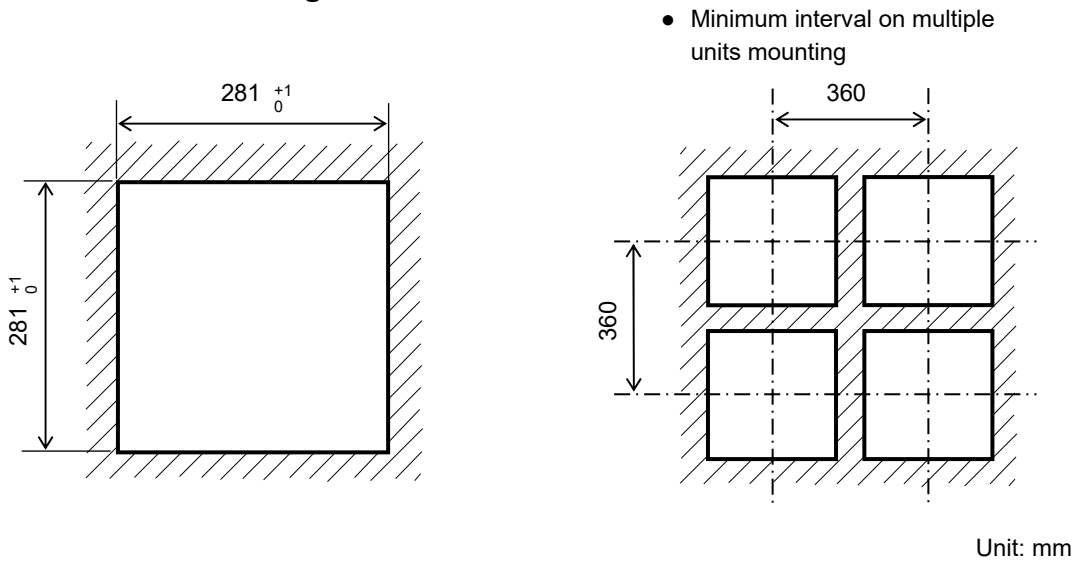

- (1) Insert the unit into the panel cutout from the front of the panel.
- (2) Screw lightly two provided mounting screws into the screw holes on left/right side (two locations in total) of the recorder.
- (3) Insert the hexagon heads of screws installed above into the round holes of brackets, (from the front) sliding them as shown in the figure, press it firmly against the panel, and tighten them with the provided wrench or a Phillips-head screwdriver. In addition, the tightening torque of the screw is 2Nm (for use of a Phillips-head screwdriver).

* Note that the left bracket differs from the right one (Mounting must be performed by two persons).

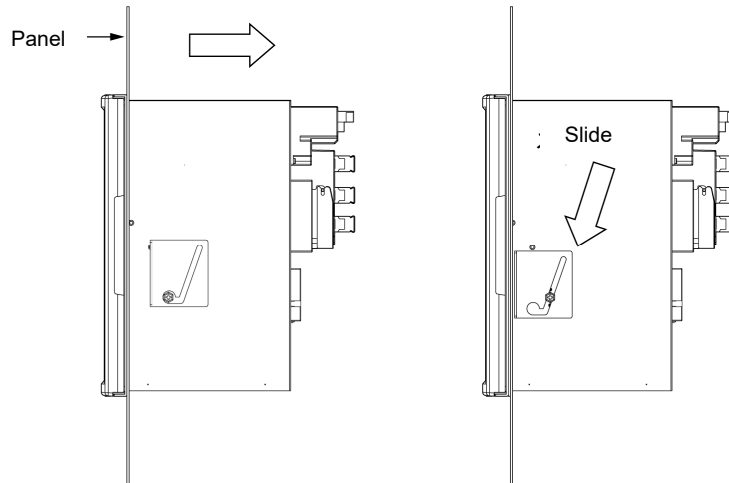

2. Mounting condition



Caution

To avoid accidents, make sure to read and understand the following.

Industrial environment

Select a location distant from sources of electric field or magnetic field and without mechanical vibration or shock.

- Overvoltage categoryII (EN standard)
- Pollution degree2 (EN standard)
- Short-term temporary overvoltage 1440V
- Altitude2000m or less
- Working place Indoor
- Long-term temporary overvoltage 490V

Normal operating condition

- Ambient temperature .. 0 to 50°C (20 to 65%RH, non-condensing)
- Ambient humidity 20 to 80%RH, non-condensing (5 to 45°C)
- Power voltage General specification: 100 to 240V AC $\pm 10\%$
- Power frequency General specification : 50/60Hz $\pm 2\%$

Atmosphere

- For safety, avoid a location with corrosive gas, explosive gas, flammable gas and combustible gas.
- Avoid a location with dust, smoke, or steam.

Mounting angle

- Lateral tilting 0 to 10°
- Longitudinal tilting Forward tilting: 0° Backward tilting: 0 to 30°
- View angle -10 to +30° with the horizon as the standard

Angles other than the above affect the recording operation.

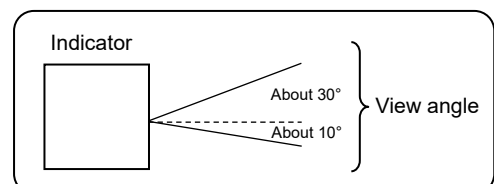

4-3. Wiring

1. Terminal board diagram

The figure below is the diagram of the terminal board with the option [Alarm relay output (12 points 'a' contact) + remote contacts (10 points) and communication interface].

Communications terminal (option) *RS232C and RS422A/485 are specified on purchase.

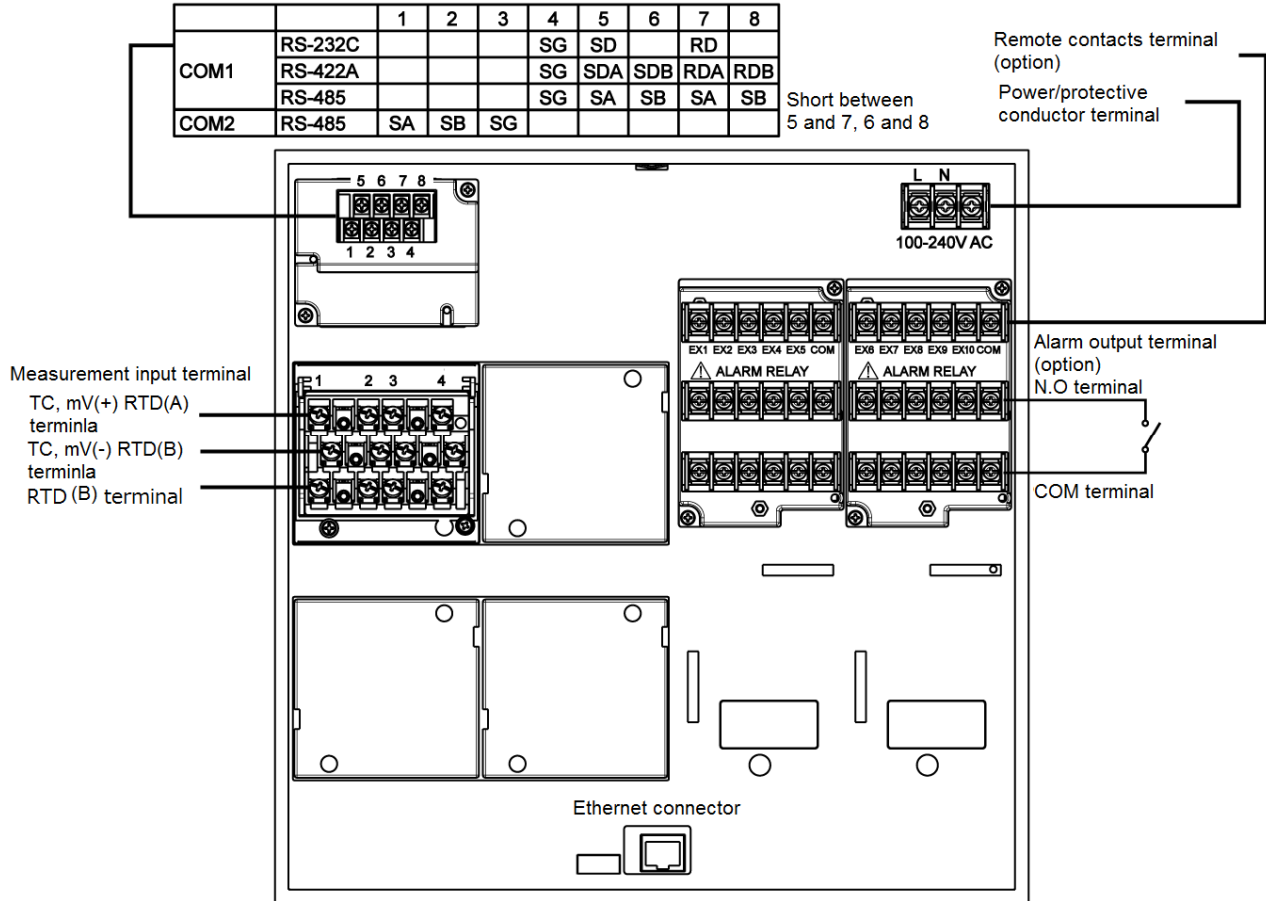

The figure below is the diagram of the terminal board with the option [Alarm relay output (8 points 'c' contact) + remote contacts (10 points) and communication interface].

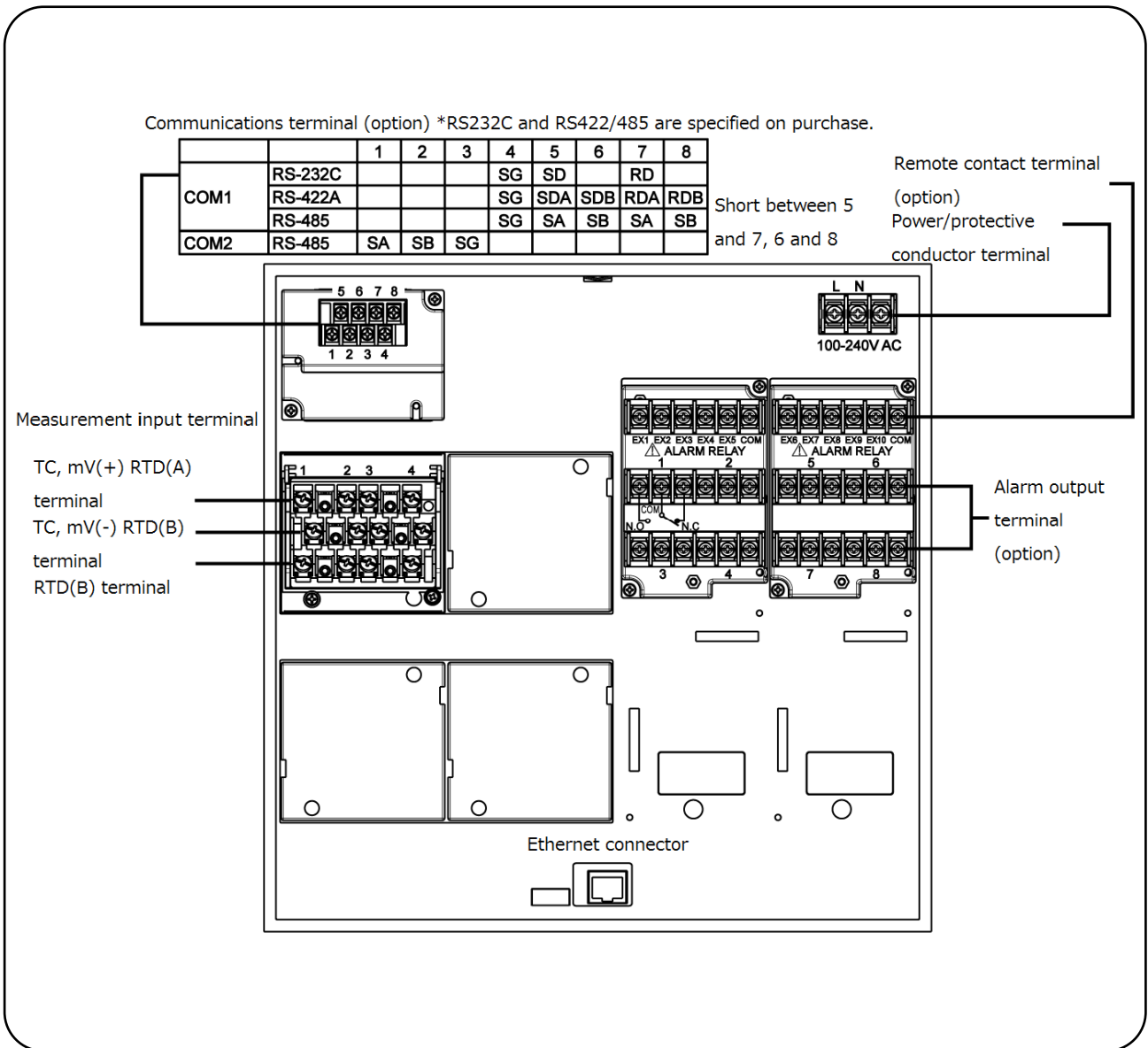

The figure below is the diagram of the terminal board with the option [Alarm relay output (2 points 'a' contact) and communication interface].

Communications terminal (option) RS232C and RS422A/485 are specified on purchase.

		1	2	3	4	5	6	7	8
COM1	RS-232C				SG	SD		RD	
	RS-422A				SG	SDA	SDB	RDA	RDB
	RS-485				SG	SA	SB	SA	SB
COM2	RS-485	SA	SB	SG					

Short between 5 and 7, 6 and 8
Power/protective conductor terminal

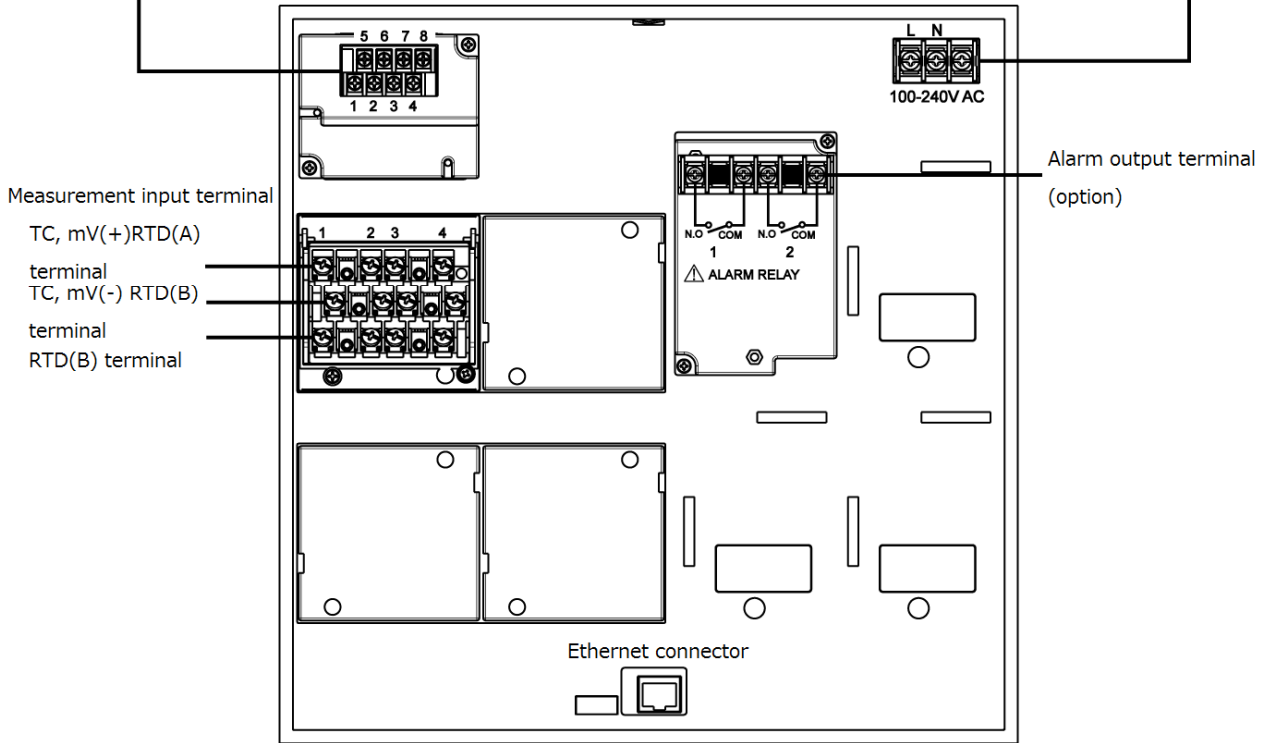



Warning

■ Alert symbol mark () and location

 Mark is attached to the location to which if human body touches, an electric shock may be generated.

Terminal name	Location of attached mark
Power terminal	Lower left of power terminal
Measurement input terminal	Upper left of terminal cover
Mechanical relay 'c' contact alarm terminal	Upper left of terminal cover
Mechanical relay 'a' contact alarm terminal	Lower left of N.O terminal

Reference

Input terminal block and alarm terminal block are removable.

For easy wiring, the input unit, alarm output/remote contacts unit, and communication unit are removable.

(1) Every unit can be removed when two mounting screws are removed.

(2) The recorder and each unit are connected with a connector.

[Input unit]

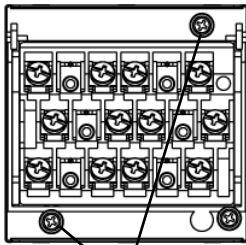

Mounting screws

[Alarm output/remote contacts unit]

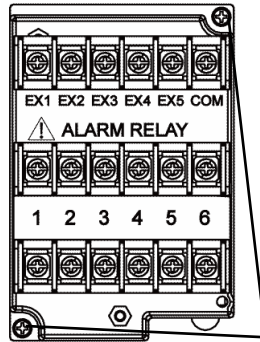

Mounting screws

[Communications unit]

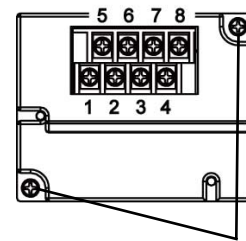

Mounting screws



Warning

■ Turn off the power and then remove/attach

Make sure to turn off the external power switch before units are removed/attached to prevent damages on electric circuits.



Caution

■ Caution at removing and replacing

Pay attention not to touch or bend the connector pins when placing or removing each unit or when the unit is removed.

Note

Thermocouple input unit replacement

Only thermocouple input unit cannot be replaced with other instrument unit. If done so, measurement errors are generated.

2. Precautions on wiring

Precautions on wiring are described below. Observe them to maintain safety and reliability.

1) Feed power source

For the power source for the unit, use the single-phase power source with stable voltage and without waveform strain to prevent malfunctions.

 Warning	<p>(1) Switch and overcurrent protective device Add a switch and overcurrent protective device (250V, 3A) to the feed power source to prevent an electric shock on wiring. The unit has no replaceable fuse.</p> <p>(2) Connect after the power source is turned OFF When performing power and input/output wiring, make sure to turn OFF the feed power source to prevent an electric shock.</p>
--	---

2) Separate from strong power circuits

For input/output wiring, avoid adjacency or parallel with strong power circuits such as power lines. Separate 50cm or more for adjacency or parallel.

3) Separate thermocouple input from heat sources.

To reduce reference junction compensation errors for thermocouple input, especially separate terminals from heat sources (heating body). Also, avoid radiation such as direct sunlight.

4) Separate from noise sources.

Separate from noise sources as much as possible. Unexpected troubles may occur. If separation from noise sources is disabled, implement countermeasures.

Main source	Countermeasures
<ul style="list-style-type: none"> • Electromagnetic switch or others • Power line with distortion of wave • Inverter • Thyristor regulator 	<p>Insert noise filters between power source and input/output terminals. CR filters are used in many cases.</p>

- 5) Use crimping terminals.
- (1) To prevent looseness or disconnection of terminals and short circuit between terminals, install crimping terminals to termination of connection cables.
 - (2) To prevent an electric shock, use crimping terminals with insulation sleeves.

Terminal Type and Termination Treatment

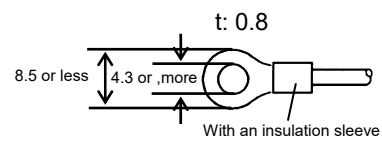
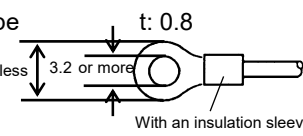
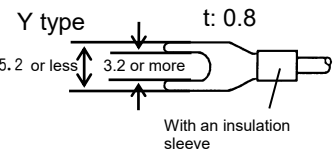
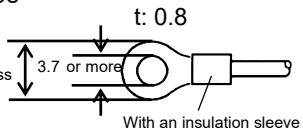
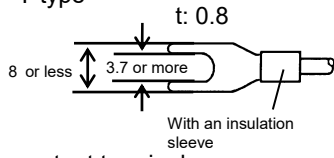
Terminal board	Diameter	Tightening torque	Termination treatment (Unit: mm)
Power/Protective conductor	M4	1.2Nm	<p>O type</p> 
Communications terminal	M3	0.5Nm	<p>O type</p>  <p>Y type</p>  <p>* Use O type as possible.</p>
Terminals other than the above	M3.5	0.8Nm	<p>O type</p>  <p>Y type</p>  <p>* Be sure to use O type for the alarm output terminals. * For other terminals, use also O type as possible</p>

- 6) Unused terminals
Avoid using unused terminals for relaying. Electric circuits may be damaged.

 <p>Warning</p>	<p>■ Treat the wired cables properly. Treat the wired cable surely so that would not get tangle up on people and objects. Disconnection of wiring may cause an electric shock.</p>
---	---

3. Power/protective conductor terminals wiring

1) Power/protective conductor terminals

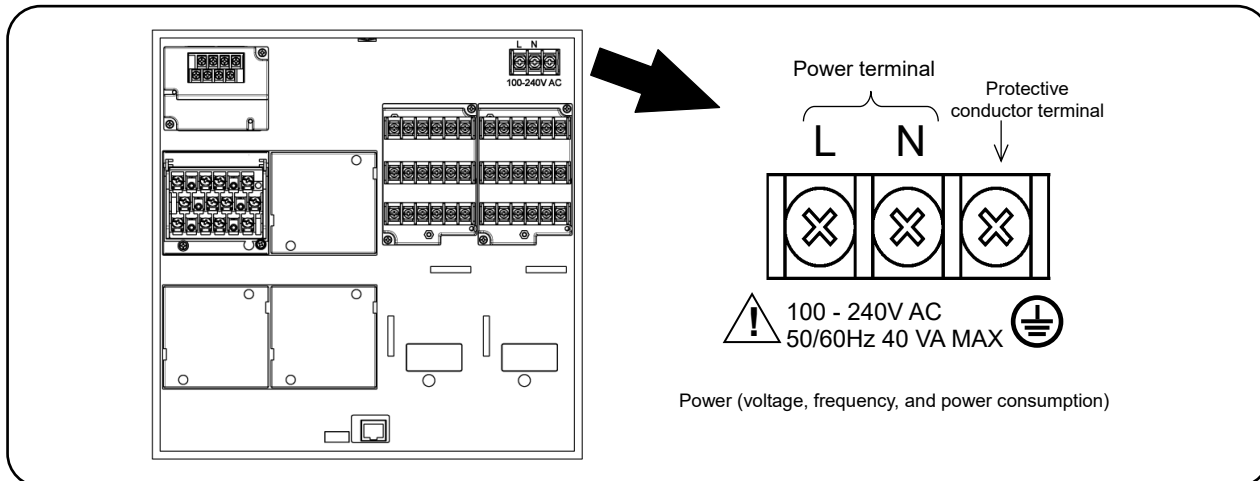

 <p>Warning</p>	<p>■ Turn OFF feed power source. Before power/protective conductor terminals wiring, make sure to turn off the feed power source to prevent an electric shock.</p>
---	---

2) Power terminal wiring

Using 600V vinyl insulated cables (AWG 20 to 16) as the power line, install crimping terminals with insulation sleeves to the termination for wiring.

Note: Use the following standard cables.

- (1) IEC 60227-3
- (2) ANSI/UL817
- (3) CSA C22.2 No.21/49

Note L/N display of power terminal



Display based on CSA standard in Canada. The live side of single-phase AC power supply is L, and the neutral side is N display. To get sufficient performance, observe the L/N wiring.

3) Protective conductor terminal wiring

Make sure to connect to the protective conductor of the power equipment. Install crimping terminals with insulation sleeves for wiring.

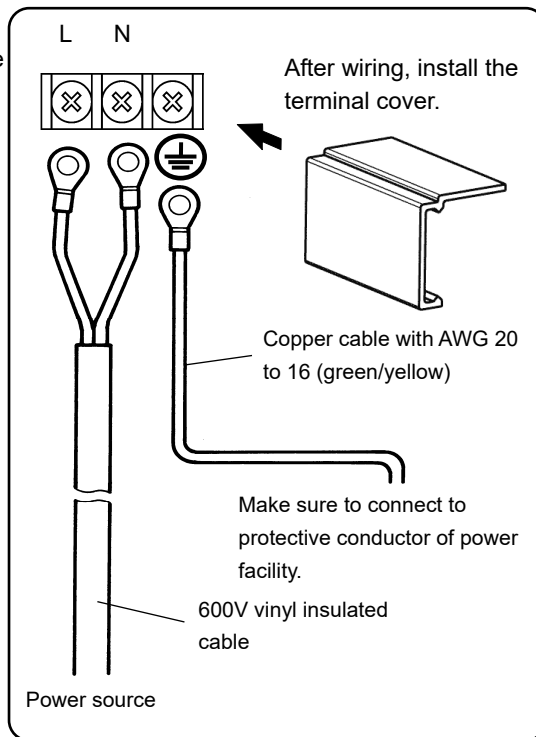
- Grounding wire: Copper cable with wire diameter 2mm² or more (green/yellow)



 <p>Caution</p>	<p>■  mark at power terminals After wiring the power terminals have power supply voltage applied. Make sure to install power terminal covers after wiring to prevent an electric shock.</p>
---	---

 <p>Warning</p>	<p>■ Pay attention to power supply voltage and noise. The power supply voltage of the unit is indicated on power terminals. Applying power other than the indicated one causes accidents or malfunction. In addition, if the power has noise interference, implement countermeasures such as noise cut transformer installation.</p>
---	---

4. Measurement input terminals wiring

- 1) Measurement input terminal
Turn OFF the feed power source before wiring to prevent an electric shock.
Install crimping terminals with insulation sleeves to input terminals for wiring.

- 2) DC voltage (current) input wiring
Use instrumentation twisted cables for measures against noise as input cables.
For current input, connect the shunt resistor for current input to the channel to be measured before wiring.

- 3) Thermocouple (TC) input wiring
Make sure to wire thermocouple cable (or compensation lead wire) to input terminals of the unit.
If a copper conductive wire is connected halfway, big measurement error will be generated.
In addition, avoid parallel connection of a pair of thermocouple wires with other instruments (controller or others) that cause troubles.

- 4) Resistance thermometer (RTD) input wiring
To prevent measurement errors, use 3-core cables as the input cable in which lines have the same resistance.
In addition, one resistance thermometer cannot be connected in parallel with other instruments (a controller or others).

Caution

■ Allowable input voltage

Input type	Allowable input voltage
Voltage, thermocouple input	$\pm 10\text{VDC}$ *
Resistance thermometer input	$\pm 6\text{VDC}$

* $\pm 60\text{VDC}$ for channels specified with $\pm 10\text{V}$ range or more
Maximum temporary overvoltage: $\pm 60\text{VDC}$

● DC voltage (current) input **Caution**

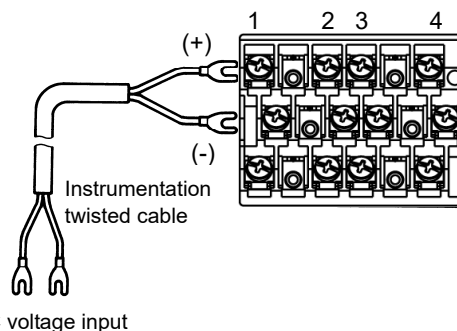

● Thermocouple (TC) input **Caution**

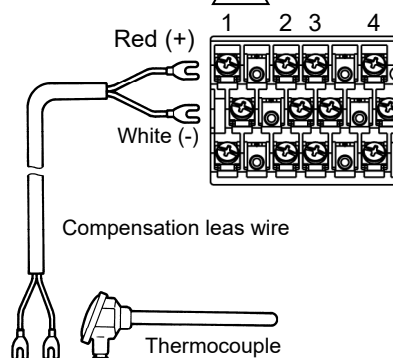

● Resistance thermometer (RTD) input **Caution**

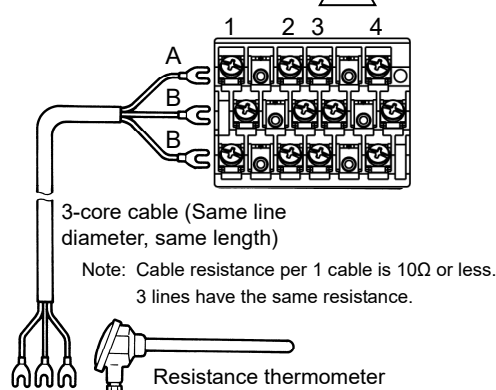

Warning

■ **Caution** mark on measurement input terminals

High voltage may be applied to the measurement input terminals due to common mode noise. Allowable noise value is 30VAC or 60VDC or less. Check that the voltage is equal to or less than the allowable value. Do not use the instrument for measurements on mains circuits. Install terminal covers after wiring to prevent an electric shock and protect input cables. For thermocouple input, installing terminal covers reduces reference junction compensation errors.

- 5) Input unit terminal cover mounting/removing
 - (1) Raise the cover to the direction of the arrow.
 - (2) Turn to the direction of the arrow.
 - (3) Pull it out to the direction of the arrow to remove.

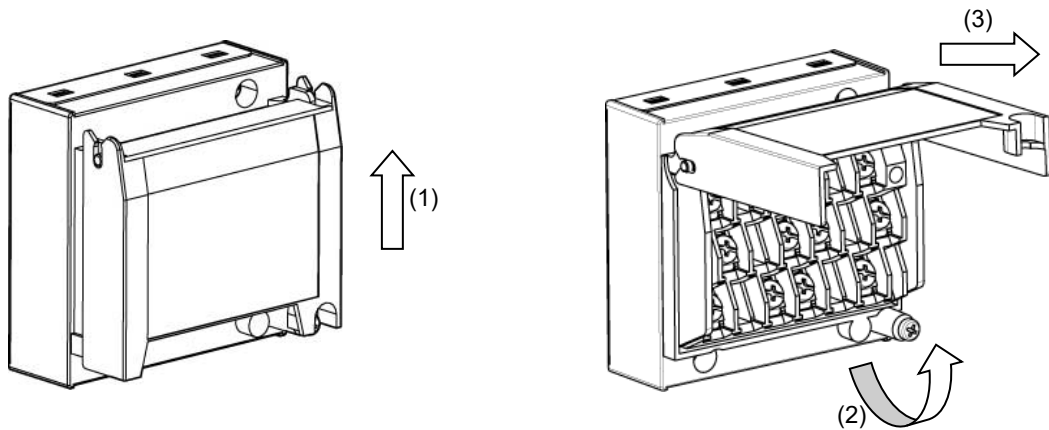

5. Alarm output terminals wiring (option)

- 1) Alarm output terminals
The terminal configuration depends on the output specification.

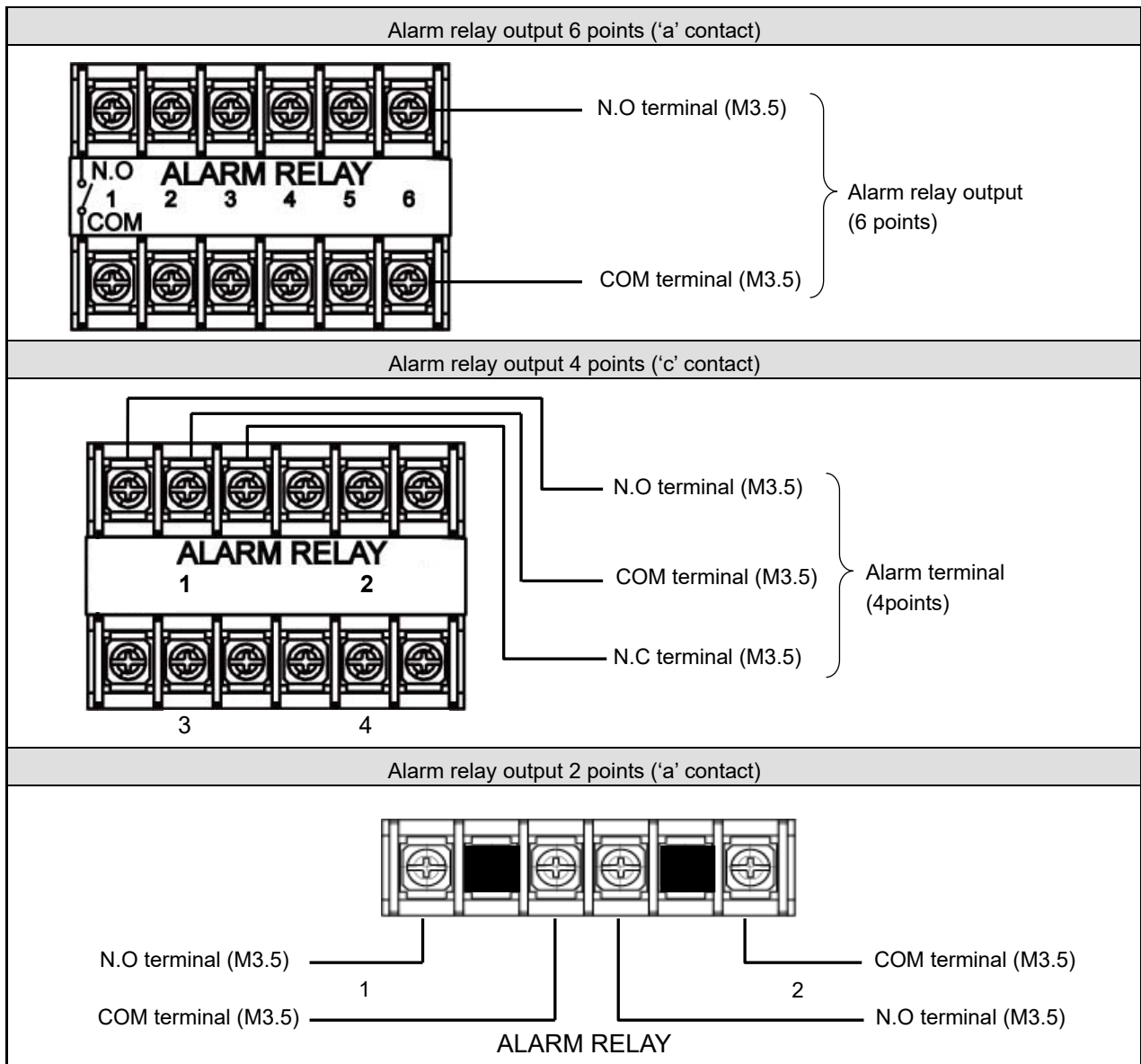

2) Wiring

Turn OFF the feed power source and the power source for buffer relay before wiring to prevent an electric shock. Use the cable of AWG 20 to 16.

- (1) Wire the cable to the load via the buffer relay.
- (2) To the alarm output terminals, type O crimp style terminal with insulation sleeve which is connected to double insulated signal wire should be connected. (Refer to 4-3. Wiring, 2. Precautions on wiring)

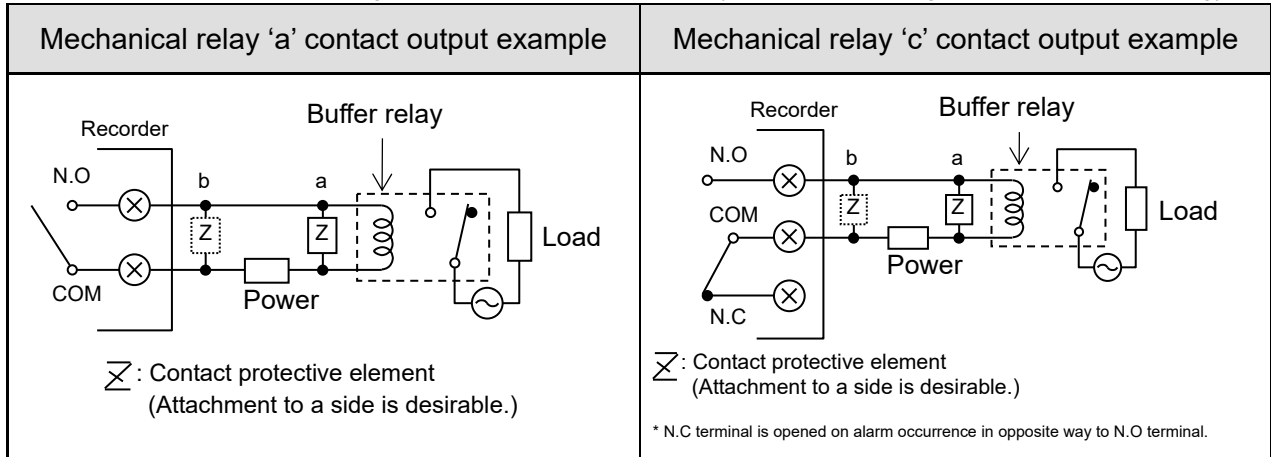



Warning

■ mark on alarm output terminals

Maximum of 240VAC can be connected to the alarm output terminals of this unit. Basic insulation (dielectric strength 1500V) is carried out between the alarm output channels, however, from the malfunction etc. 240VAC may be output to each alarm output terminals. Double insulation or reinforced insulation to the outside circuit connected to an alarm output terminal should be set and industrial environment should be overvoltage category I .

Double insulation
or
Reinforced insulation

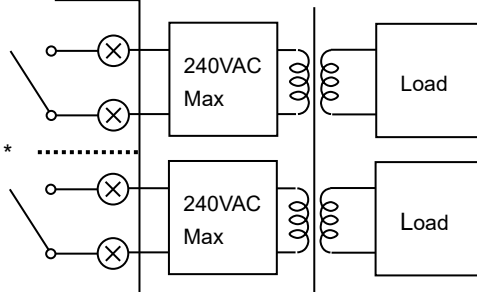

*Basic insulation between output channels

A buffer relay power supply is applied to the alarm output terminals after connections and so creates a risk of electric shock if touched. Terminal cover must be mounted after connection. Moreover, safety measures to the outside circuit should be set



Caution

■ Implement safety measures.

The alarm output of the unit may generate output failure with wrong operation, failure, abnormal input, or others. Double insulation or reinforced insulation in outside circuit side of all the channels should be set in any system for safety ensuring.

3) Precautions on wiring

The following are precautions on wiring.

Item	Description														
Mechanical relay output specification contact capacity (Common to 'a' contact and 'c' contact)	<table border="1" data-bbox="507 237 1177 383"> <thead> <tr> <th data-bbox="507 237 727 271">Power supply</th> <th data-bbox="732 237 952 271">Resistance load</th> <th data-bbox="957 237 1177 271">Inductive load</th> </tr> </thead> <tbody> <tr> <td data-bbox="507 277 727 311">100VAC</td> <td data-bbox="732 277 952 311">2A</td> <td data-bbox="957 277 1177 311">1A</td> </tr> <tr> <td data-bbox="507 318 727 351">240VAC</td> <td data-bbox="732 318 952 351">2A</td> <td data-bbox="957 318 1177 351">1A</td> </tr> <tr> <td data-bbox="507 358 727 383">30VDC</td> <td data-bbox="732 358 952 383">2A</td> <td data-bbox="957 358 1177 383">1A</td> </tr> </tbody> </table> <div data-bbox="1206 237 1434 304" style="float: right;"> (Minimum load) 100μA 100mVDC </div>			Power supply	Resistance load	Inductive load	100VAC	2A	1A	240VAC	2A	1A	30VDC	2A	1A
Power supply	Resistance load	Inductive load													
100VAC	2A	1A													
240VAC	2A	1A													
30VDC	2A	1A													
Contact protective element Z installation	<ul style="list-style-type: none"> ● Install the contact protective element which fits the buffer relay. ● It is effective to install the element to the coil side of the buffer relay (see the figure of mechanical relay 'a' contact output example) and prevents wrong operation with light load. 														
Selection of buffer relay	<ul style="list-style-type: none"> ● Coil rating: Contact capacity or less of output terminals ● Contact rating: Double of load current or more In addition, the coil surge absorption element built-in type relay is recommended. If there is no buffer relay which meets the load rating, implement another stage of buffer relay.														
Selection of contact protective element	If there is no surge absorption element built-in buffer relay, install this element. The element of C/R (capacitor + resistor) is general. <C/R standard> C: 0.01 μ F (Rating about 1kv) R: 100 to 150 Ω (Rating about 1W)														

6. Remote contacts terminals wiring and operation selection (option)

Only with remote contacts terminals (option).

1) Remote contacts terminals

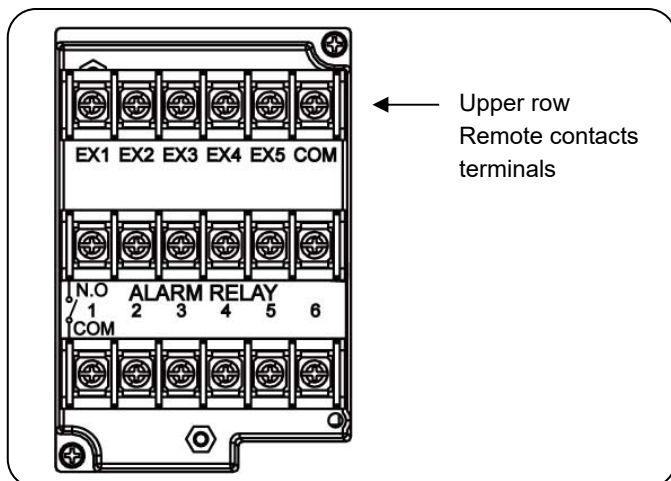

Note

Characteristics of contact input terminals

- Voltage on contact open: About 5V
- Current on contact short: About 10mA

2) Wiring

Turn OFF the feed power source before wiring to prevent an electric shock.

- (1) Use no voltage contact signals to be given to the remote contacts terminals.
- (2) Install crimping terminals with insulation sleeves to remote contacts terminals for wiring.

■ Wiring example

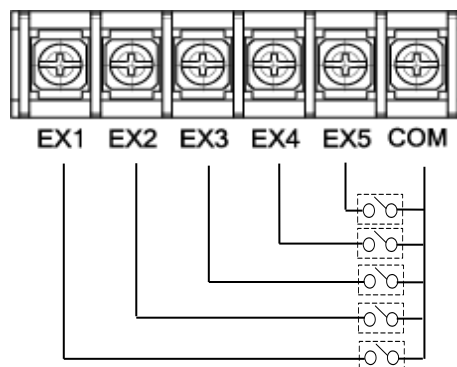

Warning

■ No voltage contact

For contacts connected to the remote contact terminals, only the circuit of secondary side which is reinforced from primary side or treated double insulation is able to be connected. Use switches or relays driven with voltage level 30VAC or 60VDC or less or manual contacts which support light load.

Reference

Remote contact

■ Remote contact enabled operation name

- (1) Recording ON/OFF and three chart speed selection (two terminals of EX1 and EX2 are used)
- (2) Messages (No. 01 and 02) selection and printing execution (two terminals of EX1 and EX2 are used)
- (3) Messages (No. 01 to 05) selection and execution (four terminals of EX1 to EX4 are used)
- (4) Digital data printing (arbitrary one terminal)
- (5) List printing (No. 1 to 3) (arbitrary one terminal for each)
- (6) Integration reset (arbitrary one terminal)
- (7) Messages No. 01 to 20 printing execution (each arbitrary one terminal)
- (8) Time correction execution (arbitrary one terminal)

Each function requires short-circuit for one second or more between COM terminal and each terminal.

■ Operation allocation

Setting of allocation of operations to each terminal (EX1 to EX10) is required.

■ Name of operations which require setting

- (1) Recording ON/OFF and three chart speed selection (See 8-7. Chart Speed Setting.)
- (2) Message selection and printing execution (See 8-13. Message Printing 1 Settings.)

3) Operation for which terminal No. is decided automatically ON: Short-circuit OFF: Open

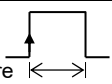
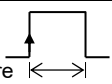
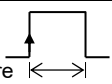
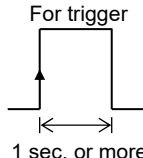
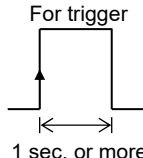
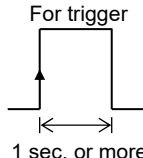
Operation name	Terminal contact signal																																			
(1) 3 chart speed selection	<p>3 chart speed setting other than the setting here is required. (See 8-7. Chart Speed Settings.)</p> <table border="1"> <thead> <tr> <th colspan="2" rowspan="2">Recording ON/OFF and 3 chart speed selection</th> <th colspan="2">Between COM and EX□ terminals</th> </tr> <tr> <th>EX1</th> <th>EX2</th> </tr> </thead> <tbody> <tr> <td rowspan="3">Recording ON</td> <td>CS1</td> <td>OFF</td> <td>OFF</td> </tr> <tr> <td>CS2</td> <td>ON</td> <td>OFF</td> </tr> <tr> <td>CS3</td> <td>OFF</td> <td>ON</td> </tr> <tr> <td colspan="2">Recording OFF</td> <td>ON</td> <td>ON</td> </tr> </tbody> </table> <p>Chart recording must be ON.</p>	Recording ON/OFF and 3 chart speed selection		Between COM and EX□ terminals		EX1	EX2	Recording ON	CS1	OFF	OFF	CS2	ON	OFF	CS3	OFF	ON	Recording OFF		ON	ON															
Recording ON/OFF and 3 chart speed selection				Between COM and EX□ terminals																																
		EX1	EX2																																	
Recording ON	CS1	OFF	OFF																																	
	CS2	ON	OFF																																	
	CS3	OFF	ON																																	
Recording OFF		ON	ON																																	
(2) Message printing (No.01 and 02)	<p>Message setting other than the setting here is required. (See 8-13. Message Printing 1 Settings.)</p> <table border="1"> <thead> <tr> <th>Message No. 01</th> <th>COM and EX1</th> <th rowspan="2">For trigger 1 sec. or more </th> </tr> </thead> <tbody> <tr> <td>Message No. 02</td> <td>COM and EX2</td> </tr> </tbody> </table> <p>At the point when the trigger signals (1 second or more) are given, the selected message is printed. Message printing with key is available.</p>	Message No. 01	COM and EX1	For trigger 1 sec. or more 	Message No. 02	COM and EX2																														
Message No. 01	COM and EX1	For trigger 1 sec. or more 																																		
Message No. 02	COM and EX2																																			
(3) Message printing (No. 01 to 05)	<p>Message setting other than the setting here is required. (See 8-13. Message Printing 1 Settings.)</p> <table border="1"> <thead> <tr> <th rowspan="2">Message</th> <th colspan="4">Between COM and EX□ terminals</th> <th rowspan="2">For trigger  1 sec. or more</th> </tr> <tr> <th>EX1</th> <th>EX2</th> <th>EX3</th> <th>EX4 *</th> </tr> </thead> <tbody> <tr> <td>No.01</td> <td>OFF</td> <td>OFF</td> <td>OFF</td> <td></td> </tr> <tr> <td>No.02</td> <td>ON</td> <td>OFF</td> <td>OFF</td> <td></td> </tr> <tr> <td>No.03</td> <td>OFF</td> <td>ON</td> <td>OFF</td> <td></td> </tr> <tr> <td>No.04</td> <td>ON</td> <td>ON</td> <td>OFF</td> <td></td> </tr> <tr> <td>No.05</td> <td>OFF</td> <td>OFF</td> <td>ON</td> <td></td> </tr> </tbody> </table> <p>* After message No. is selected, when the trigger signals (1 second or more) are given, the selected message is printed. Chart recording must be ON. Message printing with key is available.</p>	Message	Between COM and EX□ terminals				For trigger  1 sec. or more	EX1	EX2	EX3	EX4 *	No.01	OFF	OFF	OFF		No.02	ON	OFF	OFF		No.03	OFF	ON	OFF		No.04	ON	ON	OFF		No.05	OFF	OFF	ON	
Message	Between COM and EX□ terminals				For trigger  1 sec. or more																															
	EX1	EX2	EX3	EX4 *																																
No.01	OFF	OFF	OFF																																	
No.02	ON	OFF	OFF																																	
No.03	OFF	ON	OFF																																	
No.04	ON	ON	OFF																																	
No.05	OFF	OFF	ON																																	

4) Operation which can be allocated to arbitrary terminal No. ON: Short-circuit OFF: Open

Operation name	Terminal contact signal
(4) Digital data printing	<p>Turn ON the terminal No. specified to "Digital data printing." Chart recording must be ON. Digital data printing with key is enabled. Even during execution, the acceptance can be repeated only once.</p>
(5) List printing (List No.1, 2, and 3)	<p>Turn ON the terminal No. specified to "List 1, List 2, or List 3 printing." Chart recording must be ON. List printing with key is available. (See 8-12. List Printing Settings)</p>
(6) Integration reset	<p>When "Collective reset with remote contacts (EX)" is selected with "Calculation programming", turning ON the terminal No. specified to "Integration reset" resets the integration value. (See 8-4. Calculation Settings.)</p>
(7) Message printing (No.01 to No.20)	<p>Message setting other than the setting here is required. (See 8-13. Message Printing 1 Settings.) Turn ON the terminal No. specified to "Message printing (No. 01 to 20)." Chart recording must be ON. Message printing with key is available.</p>
(8) Time correction	<p>When the current time (second) is within 0 to 30 seconds, the time is corrected to zero seconds by dropping the seconds. When it is within 31 to 59 seconds, the time is put forward one minute by rounding up and corrected to zero seconds.</p>

7. Communication I/F terminal wiring (partly option)

SR can be connected for communications with RS232C, RS422A, RS485, and Ethernet.

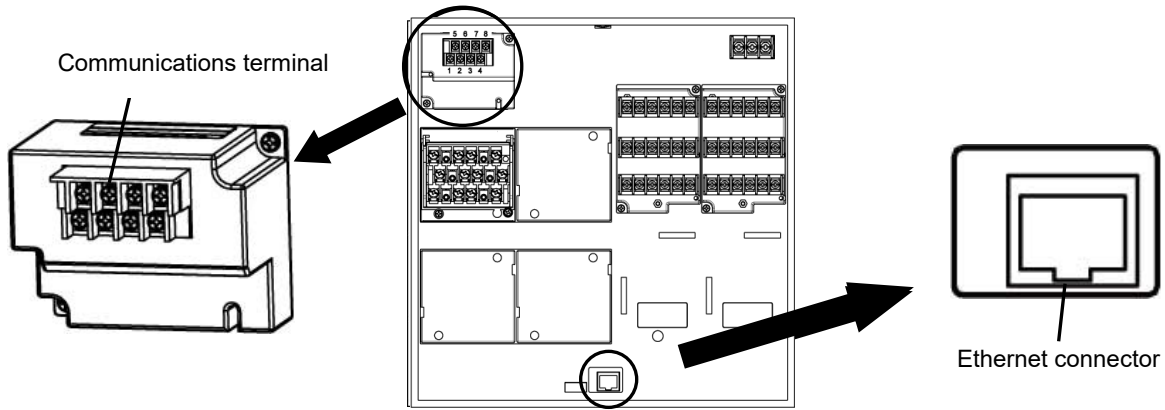

1) Communications terminal type (option)

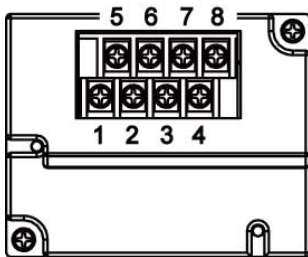

		1	2	3	4	5	6	7	8
COM1	RS232C *				SG	SD		RD	
	RS422A *				SG	SDA	SDB	RDA	RDB
	RS485 *				SG	SA	SB	Short with SA	Short with SB
COM2	RS485	SA	SB	SG					

* RS232C and RS422A/485 of COM1 are to be specified on purchase.

2) Communications cables

Please prepare communication cables before wiring in advance.

Since exclusive cables are available from us, place an order.



(1) RS232C

Connection between PC and the unit or a line converter

Cable	9-pin connector ↔ Crimp type ring terminals RS232C cable
Shape	<p>Cable for RS232C (Max.15m)</p>
Internal wiring	

(2) RS422A

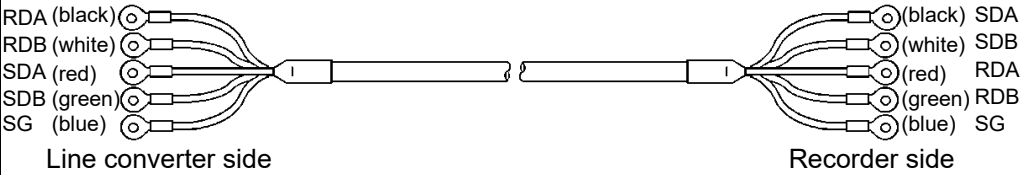
Connection between a line converter and the unit

Cable	Crimp type ring terminals ↔ Crimp type ring terminals RS422A cable (for a line converter)
Shape	 <p>4-core cable of twisted 2-core cables of twisted VCTF lines. Each side has a SG (signal ground) line. Since the line converter has no SG terminal, cut and use the cable.</p>
Internal wiring	

Connection between the unit and other devices

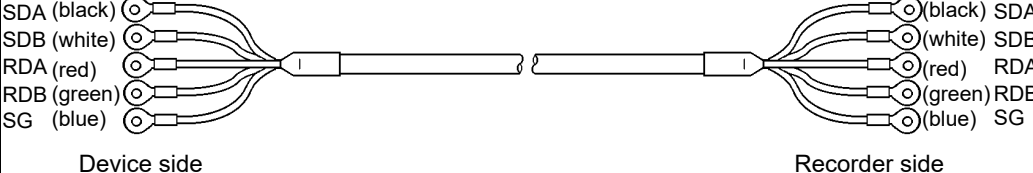
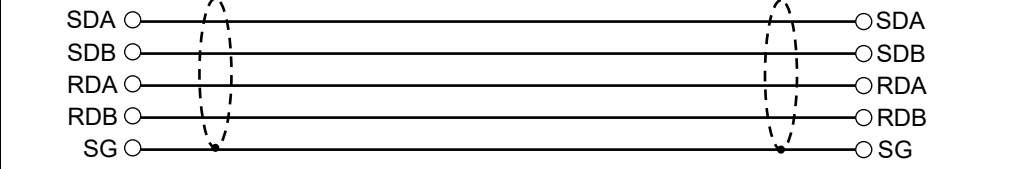
Cable	Crimp type ring terminals ↔ Crimp type ring terminals RS422A cable (for parallel)
Shape	 <p>4-core cable of twisted 2-core cables of twisted VCTF lines. Each side has a SG (signal ground) line.</p>
Internal wiring	

(3) RS485

Connection between the unit and other devices and between a line converter and the unit

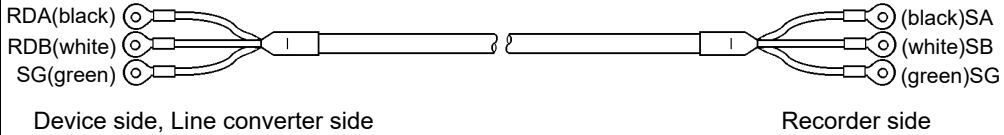
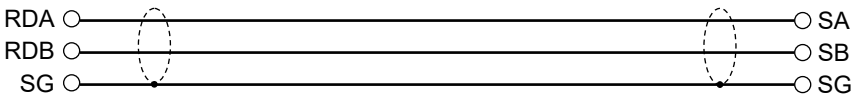
Cable	Crimp type ring terminals ↔ Crimp type ring terminals RS485 cable	
Shape	 <p>Device side, Line converter side</p> <p>Recorder side</p> <p>2-core cable of twisted CVVS lines. Each side has a SG (signal ground) line. Since the line converter has no SG terminal, cut and use the cable.</p>	
Internal wiring	 <p>RDA ○ SA</p> <p>RDB ○ SB</p> <p>SG ○ SG</p>	

(4) Ethernet

- Connection between PC and devices

For direct (one-to-one) connection, use crossover twist-pair cables with shield (available locally as STP cable).

- Connection between HUB and devices (multiple devices can be connected)

For (one-to-N) connection between PC and devices via HUB, use straight twist-pair cables with shield (available locally as STP cable).

3) Communications line wiring

(1) RS232C wiring

PC and devices are connected one-to-one with RS232C.

Example of terminal connection

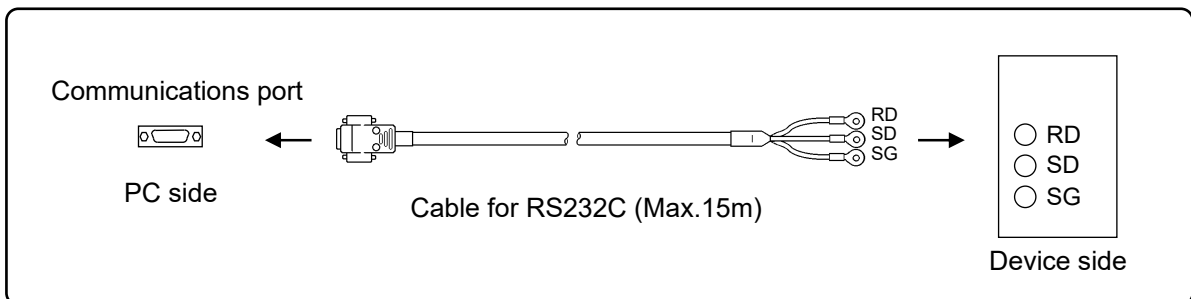

(2) RS422A wiring

PC and multiple devices are connected with RS422A. A line converter is required.
 RS422A cable is within 1.2km of total extension and up to 31 devices can be connected.
 Install a resistor of 100Ω to the last edge of the transmission line device side.
 (General metal film resistors will be fine. They are available from us, place an order.)

Example of terminal connection

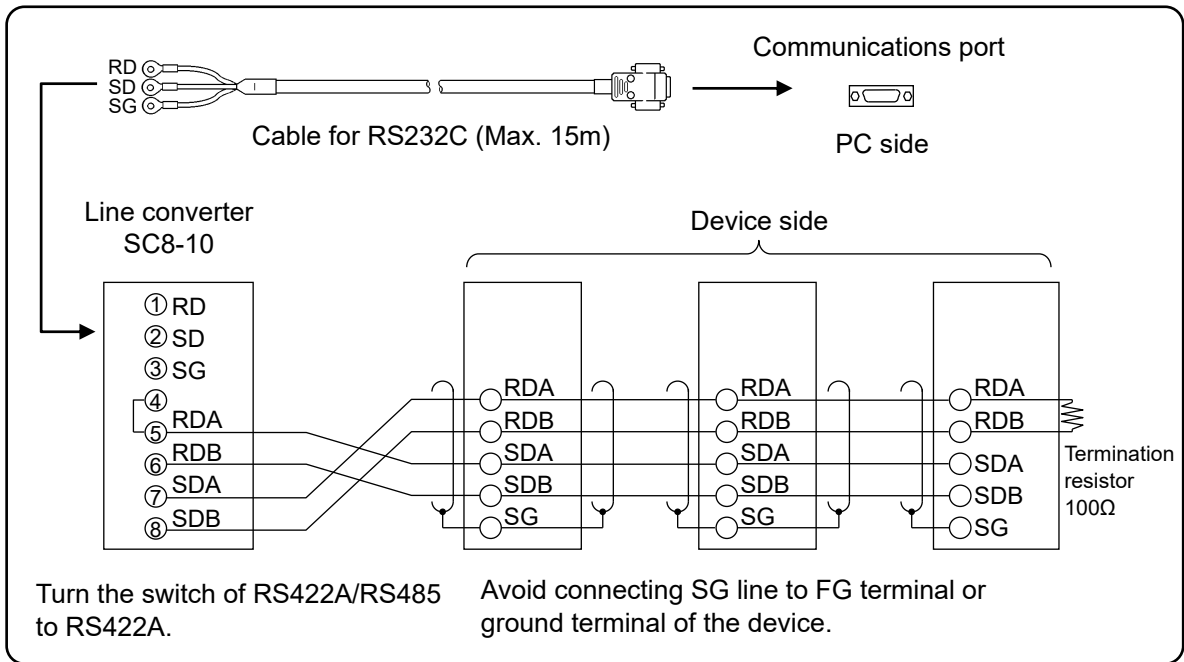

(3) RS485 wiring

PC and multiple devices are connected with RS485. A line converter is required.
 RS485 cable is within 1.2km of total extension and up to 31 devices can be connected.
 Install a resistor of 100Ω to the last edge of the transmission line device side.
 (General metal film resistors will be fine. They are available from us, place an order.)

Example of terminal connection

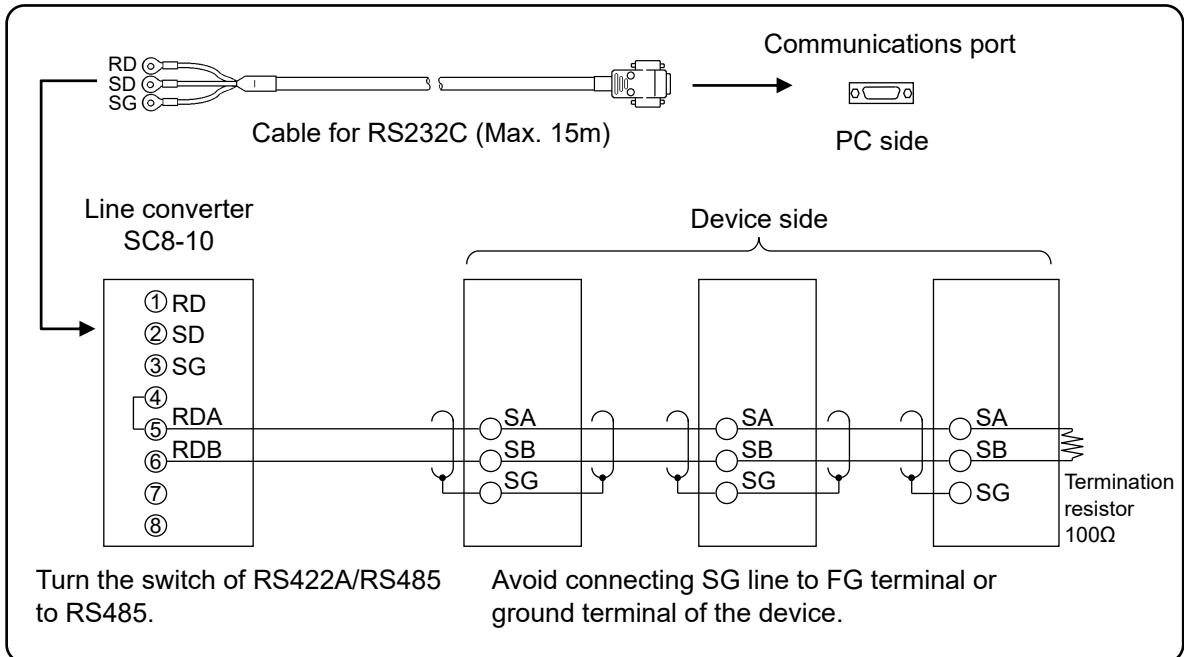

(4) Ethernet wiring

- Example of connection between PC and Ethernet devices (one-to-one connection)

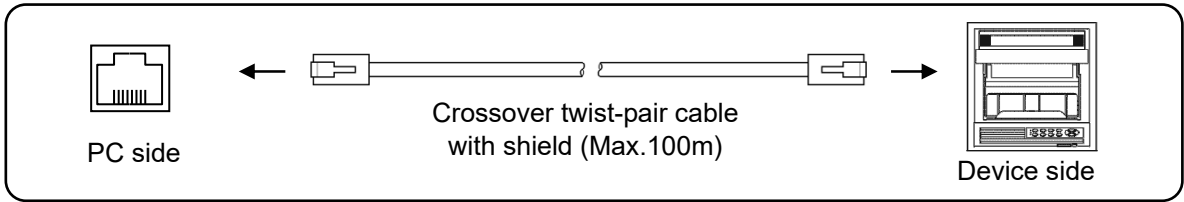

- Example of connection between PC and HUB/Ethernet devices (one-to-N connection)

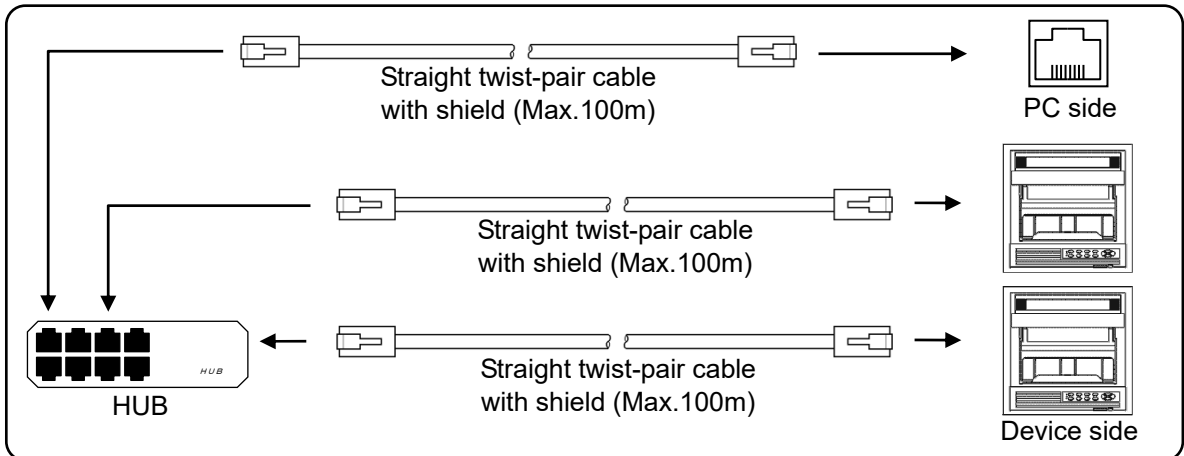

- Example of connection of devices (one-to-one connection)

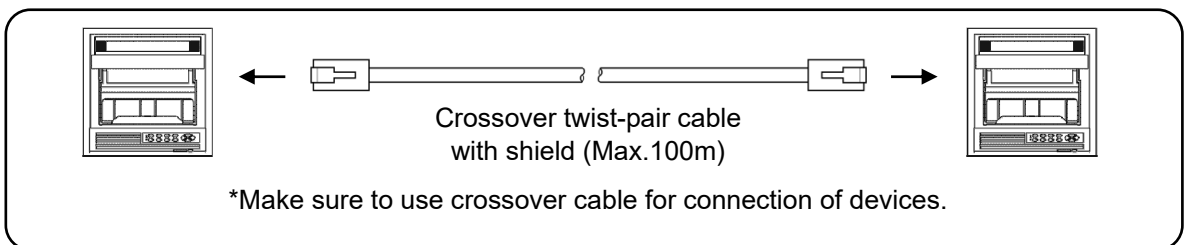

5. Part Names

5-1. Front Section of Internal Unit

Power switch
Open the display board same direction as the unit door.
The power switch is located at the upper left of the unit.

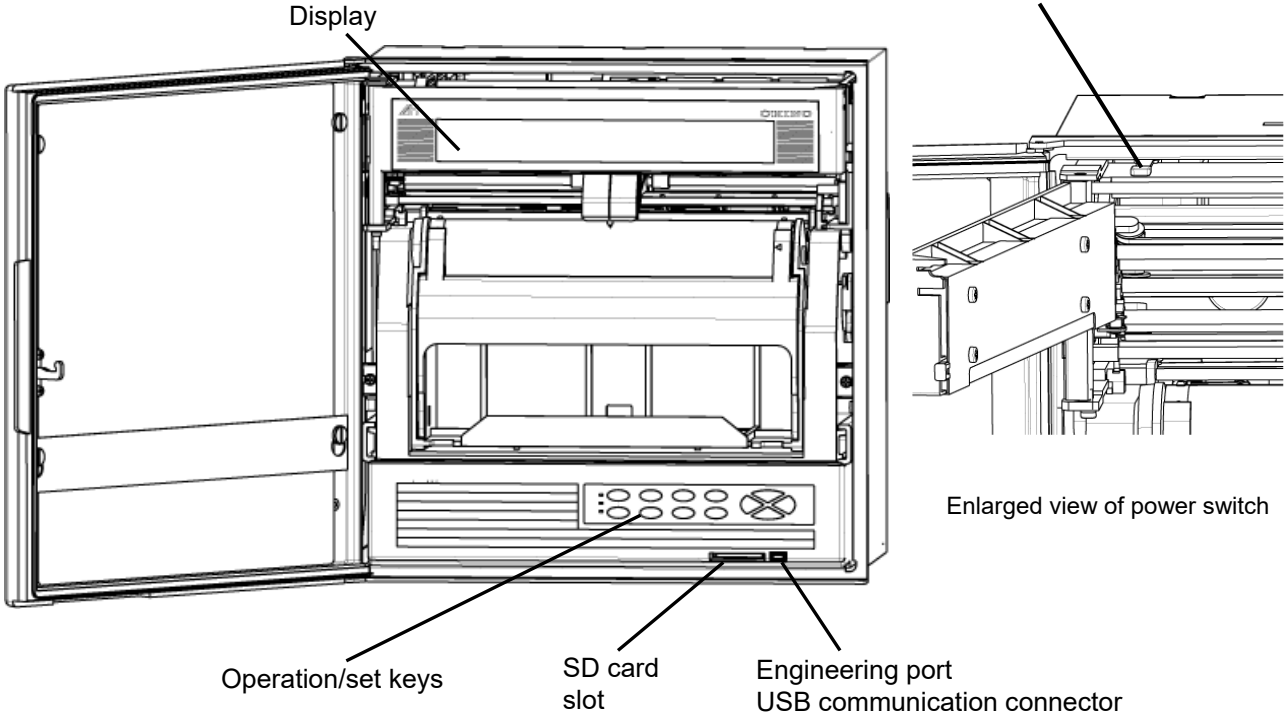

Note 1 How to handle the door

The front of the door is made of glass. Avoid giving any shock to the glass or giving any strong force to the frame for preventing any injury due to breakage.

Note 2 Operation/set key

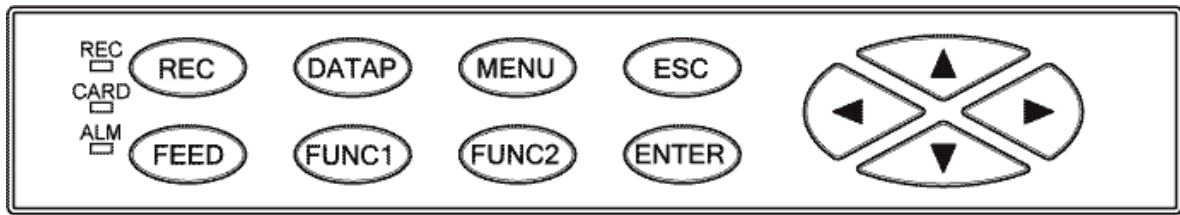

Avoid closing the door in the state of operation/set keys opened. If the door is closed in the state of the operation/set keys opened, the mechanism of the operation/set keys allows the operation/set keys to be lifted to the direction for closing to prevent damage; however, behavior for protection is not guaranteed. If the door is closed forcibly or fast, it may be damaged.

5-2. Operation/Set Keys



Status LED

- REC
Lights in green while recording is ON. Recording is turned ON/OFF by the  key.
Flashes when chart ends.
- CARD
Lights in green when SD card is recognized by the unit, or flashes in a recognition process.
- ALM
Flashes in red when alarm occurs.

Key names		Functions
REC	Record key	Turns ON/OFF recording. Used with the  key.
FEED	Feed key	Feeds chart at a speed of 600mm/min while this key is pressed.
DATAP	Data print	Prints the data at the time of pressing this key. Used with the  key.
FUNC1	Function 1 key	Switches and sets functions (function is shown on the display).
FUNC2	Function 2 key	Switches and sets functions (function is shown on the display).
MENU	Menu key	Displays various setting items.
ESC	Escape key	Returns to the previously displayed screen.
▲/▼ ◀/▶	Up/Down Left/Right	Moves the cursor up/down and left/right. Used also to select setting items or values. Used also to advance the channel number.
ENTER	Enter key	Used to register various settings.

6. Operation

6-1. Preparation for Operation

1. How to set chart paper

Note 2 Chart feeding holder

When opening the chart feeding holder, hold resin part.

Note 1 Handling of chart cassette

Be careful of injury by dropping the chart cassette after pulling it from inner unit. Take care not to catch your fingers in the unit when putting the chart cassette back.

1. Pulling out the chart cassette

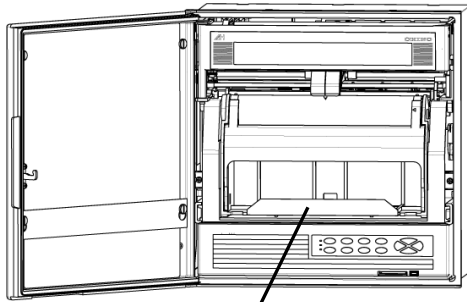
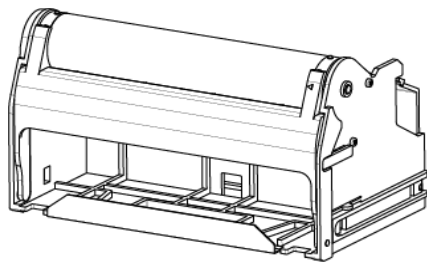
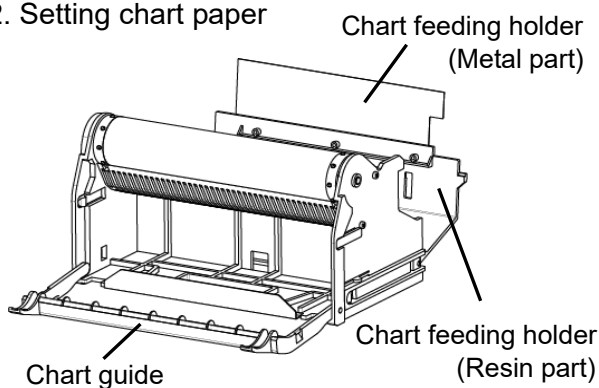

Chart cassette grip



- (1) Open the unit door.
- (2) Hold the chart cassette grip and pull it toward you.
- (3) Each pen rises up when pulled out the chart cassette.

2. Setting chart paper



- (1) Open the chart guide and chart feeding holder.
- (2) Loosen the both ends of chart to prevent double feed.



“Attention”
Red print surface

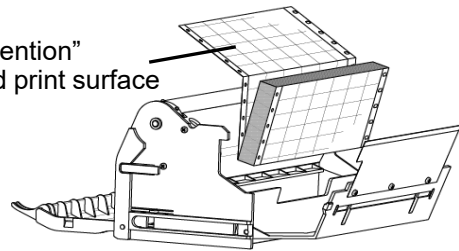

- (3) Set chart in the chart housing at the back of the chart cassette. The “round” hole and “oval” hole should be at the left and right side of the chart respectively. Make sure to set chart in the correct direction.

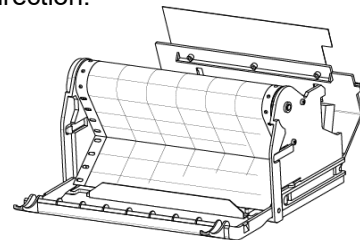

- (4) Draw out chart approximately 20cm and set holes on the both ends to the sprockets of the chart drum. Put two or three folds of chart in the chart tray at the front of the chart cassette and then close the chart guide and chart feeding holder opened in the step (1).

Thumb wheel

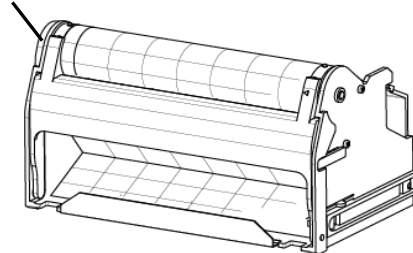



- (5) Turn the thumb wheel downward and make sure that the holes on the both ends of chart are not released from the sprockets, and feeding is smoothly done.

3. Returning the chart cassette to the inside of the unit

- (1) Align the guide of the chart cassette with the guide rail located at the both sides of the internal chassis and then insert the cassette until it is locked.
- (2) Operate the **FEED** key to check if the chart is fed properly and smoothly. If not, reset the chart again.

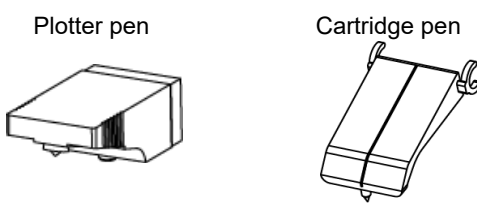
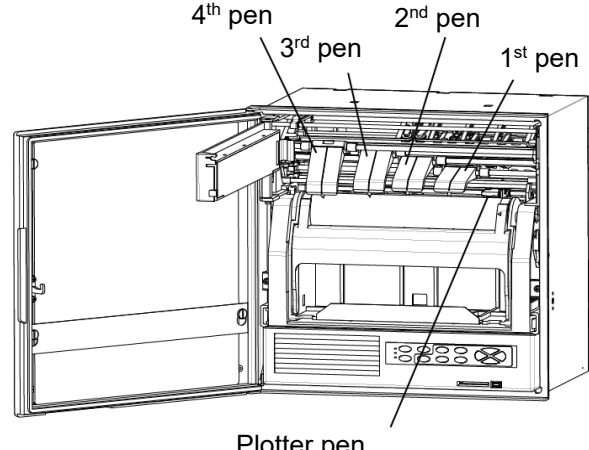
2. How to set plotter pen and cartridge pen

<p>1. Recording pen types</p> <p>(1) There are two types of recording pens, the plotter pens for digital printing and cartridge pen for trace printing.</p> <p>(2) There are four kinds of cartridge pens for the 1st pen to the 4th pen. These are of same shape but differ in ink colors.</p>	 <p>Plotter pen</p> <p>Cartridge pen</p>															
<p>2. Preparation</p> <p>(1) Confirm that the recorder is turned on and press REC → ENTER key (recording is off state).</p> <p>(2) Cartridge pen and plotter pen stop at standby position and rise up.</p> <p>(3) Prepare each pen. After opening aluminum package, remove the pen cap.</p> <p>(4) Open the door and display panel to the same direction.</p> <p>(5) Replace the pens while the chart cassette is in the housing.</p>	 <p>4th pen</p> <p>3rd pen</p> <p>2nd pen</p> <p>1st pen</p> <p>Plotter pen</p>															
<p>3. Pen replacement mode [Rep.Pen]</p>  <p>REC 2011/12/14 09:07:36 25mm/H</p> <p>12.3°C</p> <p>ESC ↑ ↓ MENU</p> <table border="1" data-bbox="159 1265 766 1377"> <tr> <td>COM 1</td> <td>E-mail</td> <td>Op.e. Rec</td> <td>Date</td> <td>*</td> </tr> <tr> <td>COM 2</td> <td>*</td> <td>FailOut</td> <td>System</td> <td>*</td> </tr> <tr> <td>*</td> <td>*</td> <td>*</td> <td>SysInfo</td> <td>Rep. Pen</td> </tr> </table> <p>MENU Replace a pen.</p> <p>ESC ↑ ↓ ENTER</p> <p>Replace a pen</p> <p>Rep. Pen FUNC1 Start</p> <p>ESC ↑ ↓ FUNC1</p> <p>Replace a pen (Pen1)</p> <p>Rep. Pen (END) Next ESC End</p>	COM 1	E-mail	Op.e. Rec	Date	*	COM 2	*	FailOut	System	*	*	*	*	SysInfo	Rep. Pen	<p>(1) Set to the pen replacement mode. Pressing MENU key displays menu screen (programming items).</p> <p>(2) Select [Rep.Pen].</p> <p>(3) Press FUNC1 key and start pen replacement.</p> <p>(4) All the cartridge pens move to the center. Each press of ENTER key moves each pen to the far left, replace the pen in order.</p>
COM 1	E-mail	Op.e. Rec	Date	*												
COM 2	*	FailOut	System	*												
*	*	*	SysInfo	Rep. Pen												

4. Setting plotter pen

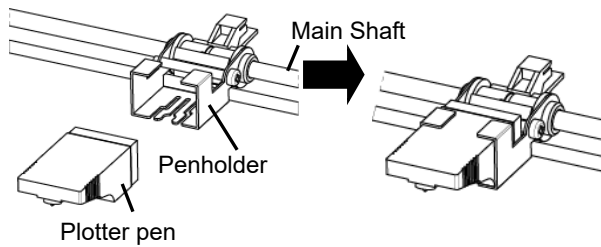

(1) Insert the plotter pen into the penholder until it stops.

(Note) Incomplete insertion may result in recording troubles.

(2) For removing of the plotter pen, pull it from the penholder.

Ref 1 Setting plotter pen

Insert the plotter pen until it makes clicking sound. When the insertion is done correctly, "A" part fits into the penholder.

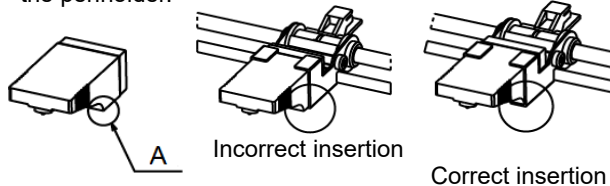

Note 1 Attachment/removal of cartridge pen

When loading or replacing the cartridge pen, make sure to turn the power off, be in the state of REC OFF or perform under the pen replacement mode.

Otherwise the dotting mechanism operates during cartridge pen replacement and unexpected force is applied to the mechanical parts then the instrument may be damaged.

Do not move the recording structure right/left by force.

5. Setting cartridge pen

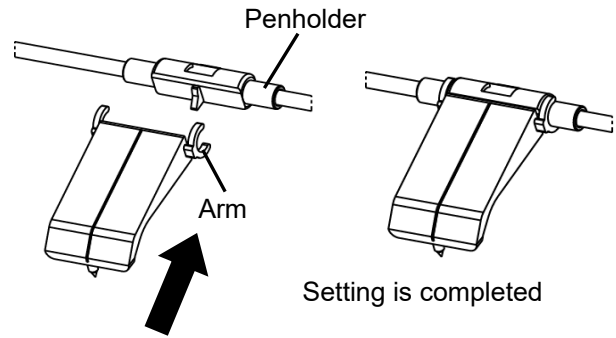

(1) Push the arms of the cartridge pen into the penholder as an angle shown in the figure.

(2) For removing, pull out the cartridge pen as direction shown in the figure below.

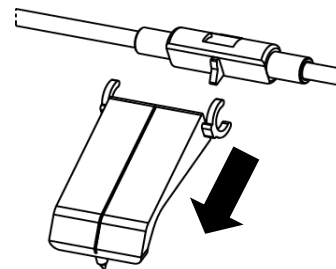

Ref 2 Colors of the cartridge pen

Determine the pen number by the color of the cartridge pen.

Red: 1st pen
Green: 2nd pen
Blue: 3rd pen
Brown: 4th pen

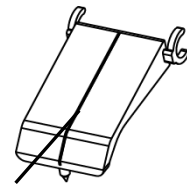

Index of the color

Note 2 Maintenance of pens

1. Pen tip

The pen tip is made of felt material. If an excessive force is added to it, the top of the pen tip will be crushed and making clear printing or tracing becomes impossible.

2. Pen cap

Each pen is provided with a pen cap for preventing drying and protecting the pen tip. Remove and retain the pen caps before setting the pen. For stopping the recording more than a day, remove the pen then put the cap on and store it.

3. How to set power frequency

Set the power frequency of the utilized region, setting so does not relate to operation of the unit directory, but this will result in the reduction of the power supply noise. Default setting is 50Hz, switch the power frequency in the region of 60Hz.

Refer to "8-26. System Settings" for power frequency settings.

6-2. Basic Operation

1. Power on

Turn the power switch to ON while the chart cassette is in the housing.

Data will be shown on the display after about 10 seconds.

After detecting the initial position, the printer prints the date and time and then feeds chart about 5mm.

Note 1 Display backup

Backup of settings, clock and display mode are made.
However, channel number is not saved so the data with smallest channel number within set range will be displayed.

Note 2 While recording is OFF

The date/time printing is not performed at power-on.

2. Language setting

The language setting is displayed at initial startup or after memory clear.

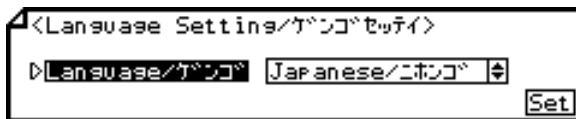

Press the **ENTER** key to make it available for setting and then set the display language with the **▲/▼** keys.

Language can be selected from English and Japanese.

When setting is completed, move the cursor to **Set** and press the **ENTER** key to register the setting.

The language setting can also be set later.

(Refer to “8-28 Soft Dip Switch Settings” in the instruction manual for “General” provided separately.)

3. Switching of display

The unit can provide seven display modes depending on the number of inputs.



On 1-point display, 1-point + bar display, 2-point display and 2-point + bar display, either fixed or sequential display can be selected for each display mode (pressing the **FUNC1** key switches the display between AUTO: sequential and CONST: fixed).

With the sequential display, channel number advances every two seconds (factory default which can be changed). While holding down the **ESC** key, press the / key to change the display mode.

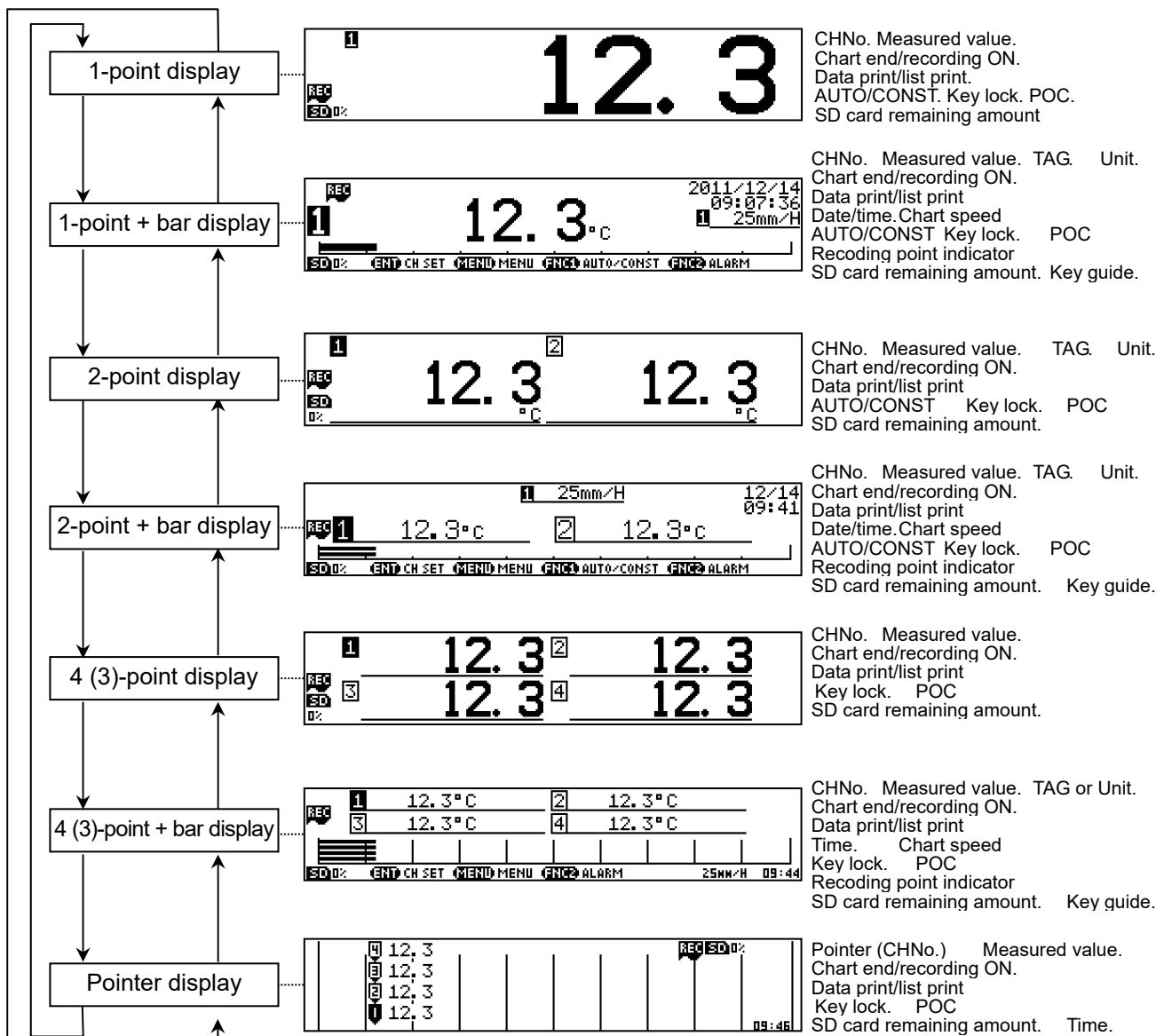
See "8-23. Display Settings" to set default display mode at power-on.



↓: ESC + ▲ ↑: ESC + ▼

To switch from "1-point display" to "1-point + bar display", press the  key while holding down the **ESC** key.
 To switch from "1-point display" to "Pointer display", press the  key while holding down the **ESC** key.

4. Chart recording operation

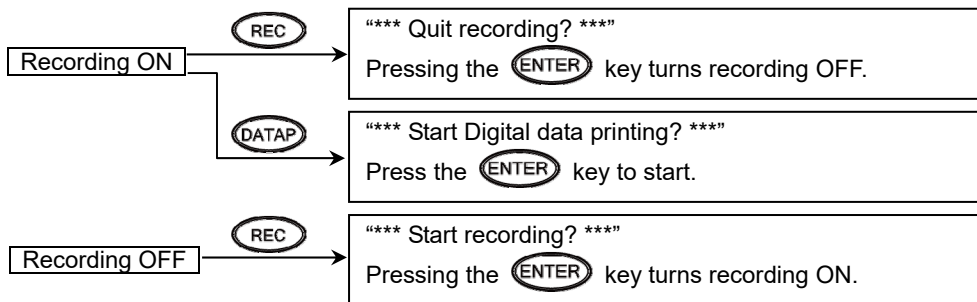

* Any of the above settings can be cancelled by pressing the **ESC** key.
(The setting is cancelled also after about 10 seconds without key operation.)

1) Turning ON/OFF chart recording

Recording can be turned ON/OFF by pressing the **REC** key → **ENTER** key.
While recording is ON, the “REC” status LED lights up.

Recording is not performed while it is OFF, but reading inputs, updating data and calculating alarms are performed. Data printing, list printing and message printing are unavailable.

Note 1 Pressing the **REC** key → **ENTER** key becomes invalid in some cases

- (1) Key operation is unavailable when  is shown on the display indicating that keys are locked.
- (2) When using remote contacts (optional), key operation becomes unavailable when recording is turned OFF by a remote contact terminal.

Note 2 Ink bleeding on the chart

This recorder is pen type. Due to the setting condition of the recorder or movement from the actual input signal, pens may draw lines on the same place of the chart many times and so ink may bleed on the chart. If ink bleeds on the chart, change setting condition, such as setting chart speed faster, to prevent ink bleeding.

Reference 1 Up and down of pens

- (1) When the printing is turned off, each pen lifts up automatically. Even if the power is turned off in this condition, this pen position is maintained.
- (2) When the chart cassette is pulled out, each pen lifts up. If the printing has been turned off when pulling out the chart cassette, each pen has already been lifted up and it maintains its position.

Reference 2 Printing Operation

The table below explains the printing operation when the printing is ON or OFF.

Operation	ON	OFF
Chart feeding	Execute	Stop
Trace printing (Cartridge pen)	Execute	Up at where it is
Digital data printing (Plotter pen)	Execute	Up at standby position
Up and down of pens	Down	Up

2) Data printing

Print numeric values of the latest measurement data as shown in the example below. Printing mode is different depending on the chart speed.

When the chart speed is 1 to 499mm/H, trace printing is continued without interruption. Printing is done by synchronized with chart feeding.

When the chart speed is 500mm/H or more, trace printing is interrupted and data printing is started.

Press the **DATAP** key → **ENTER** key to perform data printing.

Use the periodic data printing function to perform data printing periodically.

This cannot be performed while recording is OFF or keys are locked.

Reference Operation during printing and print cancel

Operation: Operations including measurement continue without being interrupted.

Cancel: To stop data printing halfway through, press the **REC** key → **ENTER** key.

Then, pressing the **REC** key → **ENTER** key returns to the previous printing status.

Example of data printing

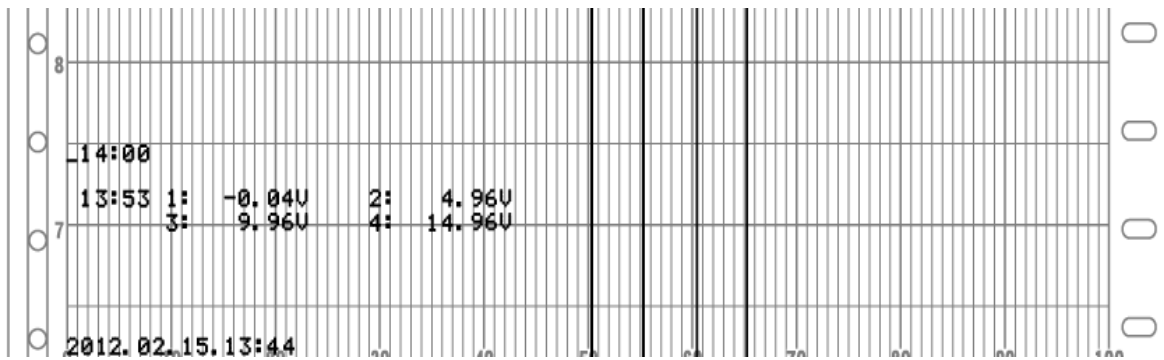

3) Chart feed

Chart can be fed using the **FEED** key.

While the **FEED** key is pressed, chart is fed at a speed of 600mm/min. When fast-feeding chart, recording is stopped.

Feed chart when a measurement target or measurement condition is changed.

Reference Feeding chart

Chart can be fed manually using the drum. However, a few millimeters of chart may not be fed due to mechanical nature of the unit. Therefore, we recommend that chart be fed by the **FEED** key.

Also, for the same reason, use the **FEED** key to feed when new chart is set.

4) Aligning time line

When operating the unit with a chart speed of multiples of 12.5 (mm/H), it is advisable to align the time line print with the time scale of chart for easier view of the result.

The following shows a bad example.

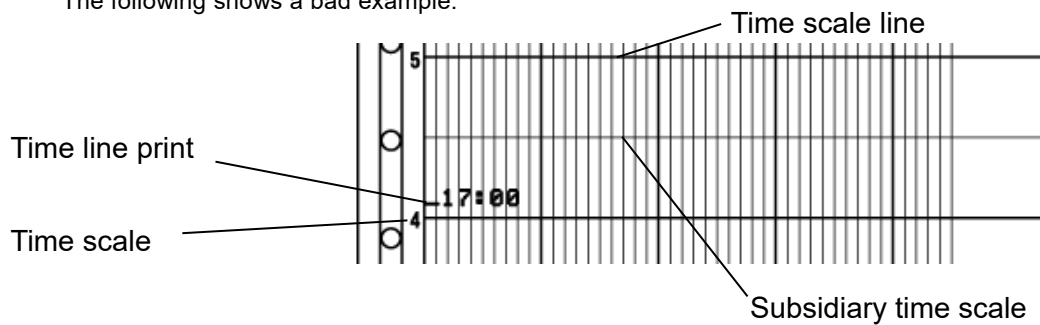

This is useful only when you use a chart with 12.5mm-pitch time scale.

- (1) There is a time line setting mark (◁) on the right side of the chart guide located at the front of the chart cassette.

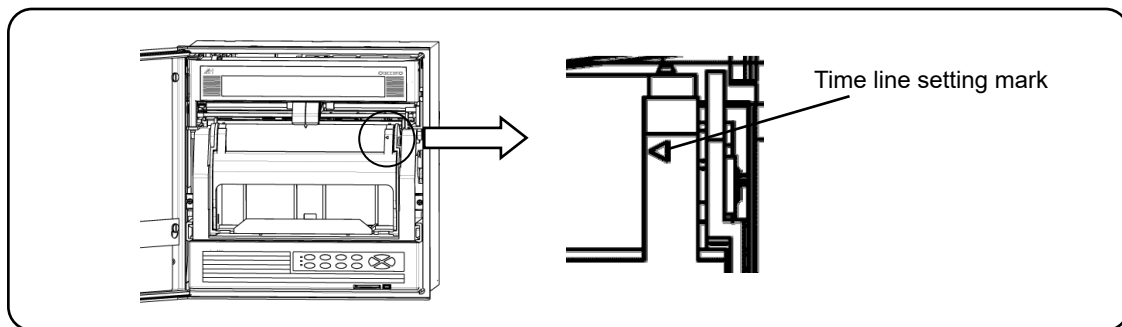

- (2) Align a time scale line with the setting mark (◁) as viewed from the front by pressing the **FEED** key (do not align it manually).

- (3) It may be a good idea to set a time scale line 1 to 2mm above the setting mark (◁) to perform a fine adjustment later.

1 to 2mm above the setting mark

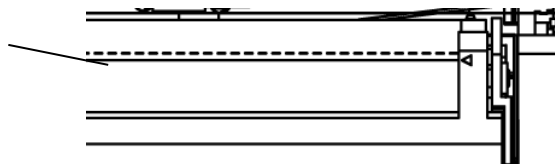

- (4) Press the **REC** key and turn off the "REC" status LED.
- (5) Press the **REC** key at a desired time <xxh 00min> and turn on the "REC" status LED.
- (6) After a few hours, check to see if the time line print is aligned with a time scale line. If the time line print comes behind a time scale line, press the **FEED** key briefly and see how it works. If it comes ahead, remove the chart and set it back for a few hours and then try again.

6-3. Operation

1. Types and contents of chart recording

There are two types of chart recording: trace printing and digital recording/printing. Without setting particular items, trace printing and fixed time printing are performed while recording is ON.

Item		Contents								
Chart recording	Trace printing (Cartridge pen)	Trend printing is executed for each pen (channel). <table border="1" style="margin-left: 20px;"> <tr> <td>1st pen</td> <td>2nd pen</td> <td>3rd pen</td> <td>4th pen</td> </tr> <tr> <td>Red</td> <td>Green</td> <td>Blue</td> <td>Brown</td> </tr> </table>	1 st pen	2 nd pen	3 rd pen	4 th pen	Red	Green	Blue	Brown
	1 st pen	2 nd pen	3 rd pen	4 th pen						
	Red	Green	Blue	Brown						
	Digital recording/printing (Plotter pen)	Alarm printing	Prints time or alarm point when alarm is generated/cleared.							
		Periodic data printing	Adds digital record/print on a trace print in desired intervals.							
		Data printing	Performs digital recording/printing when required.							
		List printing	Prints a list of all or specified parameters when required.							
		Fixed time printing	Prints date (year/month/date), time/time line (linked to the chart speed and printed), chart speed, max/min chart record, channel number and tag and unit.							
		Message printing	Prints a message which can contain up to 72 characters.							
		Calendar timer printing	Prints when both calendar timer is ON/OFF and printing are set to ON.							
		Operation recording	When using remote contacts (optional), the status of remote input No. (ON/OFF) is printed at the specified position with a bar line.							
		Setting change mark	When setting is changed, "Δ" is printed at the right side of chart.							
Power-on time printing		Date and time are printed at power ON.								
Time axis sync. mark printing		(1) When the time axis synchronization (POC) is switched ON or OFF, its time, mark (*), and ON or OFF are printed. (2) When it is ON, a mark (*) is printed to the right of the time print of fixed-time printing.								

Example of trace printing and fixed time printing

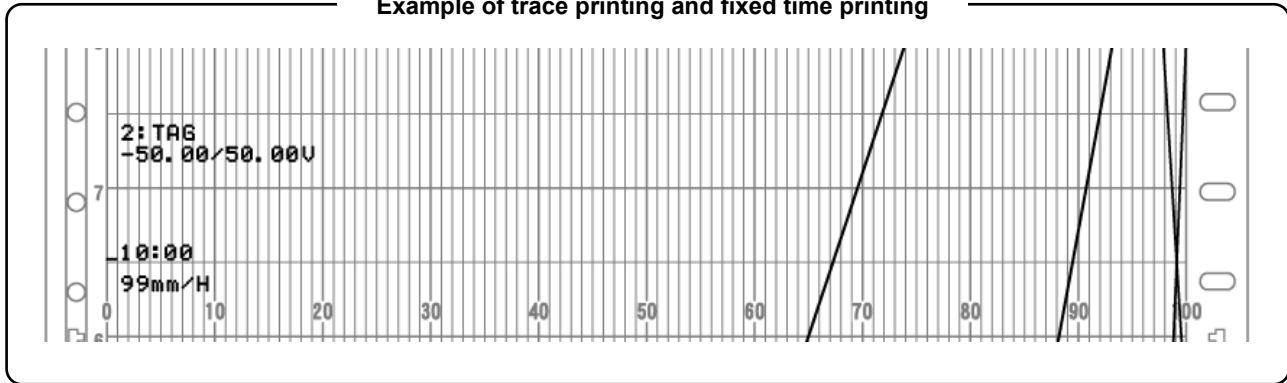

2. Fixed time printing interval

When recording is ON at the time of power-on, fixed time printing is performed first.

The following table shows printing intervals which vary depending on the printing item.

Time and time line	Chart speed	Min/max chart record, channel number and tag and unit
Varies depending on the chart speed	At approximately 84mm intervals	At intervals of 42mm and in order of channel number.

1) Printing intervals of time and time line

Time and time line are printed at the following intervals which vary by the chart speed. The start point of the intervals is 00h 00min.

Chart speed (mm/H)	Time and time line	Time line only	Year/month/date
1 - 9	12h 00min only	6h	00h 00min only
10 - 15	4h	2h	
16 - 30	2h	1h	
31 - 60	1h	←	
61 - 119	1h	30min	
120 - 149	30min	←	
150 or higher	No printing	30min	

Example:

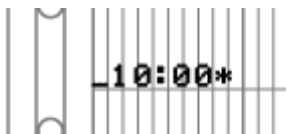
	(1) Time line (2) Time (3) POC mark (print only when time axis synchronization is ON))
---	--

2) Printing interval of max/min chart record, channels number and tag and unit

(1) These are printed at intervals of 42mm and in order of channel number.

(2) Tag is not printed if not specified.

(3) When you set the recording format, printing contents vary depending on the selected format.

(4) Printing mode is different depending on the chart speed.

Standard (Standard), automatic range-shift (Auto Range)

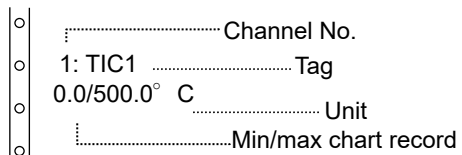
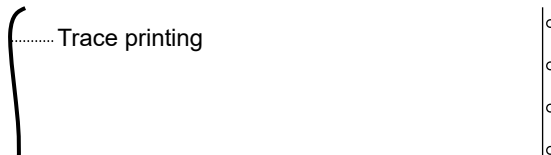
	
---	--

Note: When Auto Range is used, the max/min chart record of the range (one of the ranges R1 to R5) used at the time of printing will be printed.

Compressed/expanded printing (Comp. & Exp.Print)

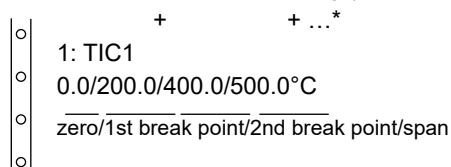

* A "+" mark is printed at the first and second break points.

Zone printing (Zone Print)

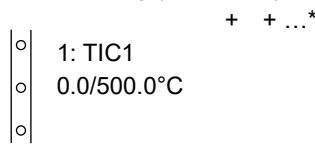
--

* A "+" mark is printed at the edge of the printing area to indicate it.

3. Restrictions on recording

- 1) Digital recording/printing unavailable at certain chart speeds
When chart speed is set to 150mm/H or higher, printing function besides time line, power-on time printing, data printing, list printing, setting change mark are disabled.
- 2) Overlapping of digital recording/printing
When the recording position is overlapped, printing may not be performed.

4. Operation at abnormal input

- 1) Out-of-range input
When an input is out of the chart printing range or measuring range, the unit indicates it by the following display or printing.
Measuring range: determined by the input type described in "8-2. Input Type Settings".
Chart printing range: trace printing range described in "8-2. Input Type Settings".

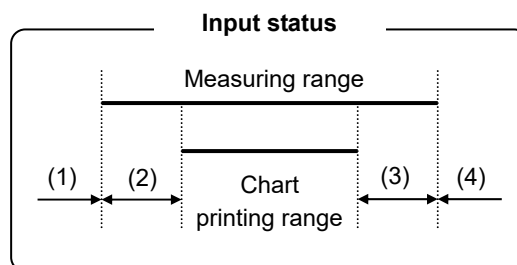

No.	Input status	Display	Printing	
		Digital	Digital	Trace
(1)	Input under the lower limit of measuring range*	-OVER	-OVER	Downscale burnout
(2)	Input under the lower limit of chart printing range	Normal display	Normal print	
(3)	Input over the upper limit of chart printing range	Normal display	Normal print	Upscale burnout
(4)	Input over the upper limit of measuring range*	+OVER	+OVER	

* Digital display/printing is available for measurement value out of the measuring range if it is within $\pm 5\%$ of the span.

- 2) Disconnection of input signal
Display and printing made at a disconnection of input signal depends on the "Burnout" setting.

Burnout setting	Display	Printing	
	Digital	Digital	Trace
None	Undefined	Undefined	Undefined
Down	BURN	BURN	Downscale burnout
UP	BURN	BURN	Upscale burnout

7. Factory Default Settings

7-1. List of Factory Default Settings

Item	Default value
(1) Time	Current time (year/month/date: Japan time)
(2) Range	(1) Input type V : -50.00 to 50.00 (2) RJ None (3) Chart printing -50.00 to 50.00
(3) Scale	-50.00 to 50.00
(4) Unit	V
(5) Tag	Not set
(6) Display/printing On and OFF	(1) Display All channels ON (2) Trace printing All channels ON (3) Digital printing All channels ON (4) SD card recording All channels ON
(7) Chart speed	25mm/H
(8) Digital recording/printing	Data interval None
(9) Alarm settings	Not set
(10) Subtract printing settings	Not set
(11) Message settings	Not set
(12) Password	3571

8. Setting Method

8-1. Basic Rules

The following provides general information on setting operations.





Pressing the  key can return to the measured value display from any window.

1. Setting items and parameters

The unit offers various condition settings to allow users to obtain various recording results and data. Major items of measuring/recording conditions, such as range, scale and chart speed, are called "setting items", whereas detailed items of each setting item are called "setting parameters" or just "parameters".





2. Selecting setting item

Press the  key on the measured value display. A list of setting items will be displayed.





Use the     keys to select a setting item and press the  key to confirm your selection. Some setting items may use hierarchical display.

3. Selecting setting parameter

Select a setting parameter of a setting item.

A cursor is displayed at the left of each parameter. Move the cursor to a desired parameter using the     keys.

4. Key acceptance and acceptance failure

When the cursor does not move by pressing the     keys or when a parameter setting window does not open by pressing the  key, it indicates that the keys have been unaccepted. Make sure to press the keys properly and try again.

5. Number of setting items and parameters

Setting items vary depending on the use of option. Also, the number of setting parameters differs by setting item. The items like time and chart speed have a single parameter whereas the items like range, scale and alarm have multiple parameters requiring channel specification.

Only the parameters necessary for the current setting become available for entry. Unnecessary parameters are replaced by "*" mark and the cursor does not move to them.

6. Checking setting parameters

There are two ways to check setting parameters: "list printing" and "display check", the former prints all or specified setting items and the latter calls up parameters on the display.

7. Changing settings

To change settings, move the cursor (▷) located at the left of a setting parameter to the parameter to be set (changed). When the target parameter is selected by pressing the **ENTER** key, the set value will be highlighted and become settable. Each setting item generally uses the combination of four types of setting described below.



A parameter value is selected from options. Use the ▲/▼ keys to select a desired value from options.

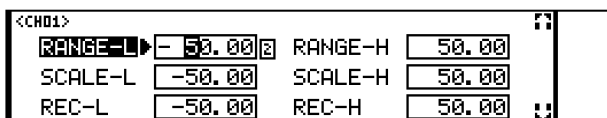

A parameter is set to an arbitrary value. Use the ◀/▶ keys to move the digit, and the ▲/▼ keys to set number or select + or -.

Note: For parameters requiring setting of decimals, a box indicating decimal point position appears at the right side when they become settable. Change the number in the box to change the decimal point position.

Some parameters show the box only for reference.



Whether or not to use the parameter is set.

Pressing the **ENTER** key checks/unchecks the check box.

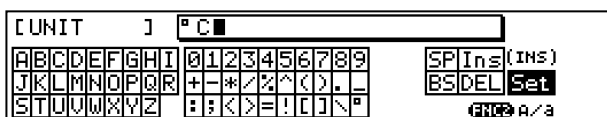

A parameter is set to an arbitrary character string. Select an insert position or character with the ▲/▼/◀/▶ keys and press the **ENTER** key to enter. When all the desired characters are entered, move the cursor to **Set** located at the far right of the window and press the **ENTER** key to register.

Use the ▲/▼ keys to move to the parameter entry and character selection areas. Use the ◀/▶ keys to select an insert or change position while “.” is displayed at the left of the parameter entry area. When you enter a character string exceeding the valid number of digits, the last digit will be deleted.

Note: Pressing the **FUNC1** key switches the entry mode: alphabets, numbers, symbols and katakana. (The mode to be switched depends on the parameter.)

When the **ENTER** key is pressed after setting (changing) a parameter value, the cursor moves to the next parameter. When all the necessary settings for each item are completed, move the cursor to **Set** at the bottom and press the **ENTER** key to register. After that, the previous window will be displayed.

At this time, if any error is detected in the settings, “Invalid setting” will be displayed and the current window will not change.

Reference List of setting items

The following table is a list of setting items displayed by pressing the **MENU** key (with full options). Some models cannot set certain items, and such items are replaced by “*” mark. Items in field will be displayed when “Rec Adj” and “Inp Adj” are enabled according to “8-26 System Settings”. Items in the same column are related to each other. Items in field are required items.

Range	Chart	DataInt	PrtForm	SD CARD	Ether	Timer	Display	Rec Adj
Alarm	POC	PrtTime	A.Range	USB	SNTP	Dig Inp	D.Order	TmAxAdj
Calc	Sub Prt	ListPrt	Cmp&Exp	COM 1	E-mail	Ope.Rec	Date	Inp Adj
Formula	*	MsgPrt1	ZonePrt	COM 2	*	FailOut	System	*
Seg.Tbl	*	MsgPrt2	*	*	*	*	SysInfo	Rep.Pen

8-2. Input Type Settings “Range”

Parameters including range, RJ (internal/external switching of reference junction compensation), scale and unit can be set collectively for each channel.

1. Parameters

- 1) Input
Set the input type (INPUT), range (RANGE-L/H) and RJ internal/external (RJ) in accordance with the sensor to be connected (thermocouple or resistance thermometer) and the target measuring range.
- 2) Burnout
If a sensor (thermocouple or resistance thermometer) or input cable is disconnected, chart recording jumps to the upper (UP) or lower (DOWN) limit. This can be reflected to the display or output.

Note 1 Set “None” for parallel operation

Connecting a thermocouple in parallel with another instrument may cause a trouble. If it has to be done, make sure to select “None” for burnout.

Please note that the recording accuracy is not guaranteed in this case.

- 3) Scale
Set the scale used for display or recording of actual input after setting input type (INPUT) and range (RANGE-L/H).
Scale setting (SCALE) is required when displaying/recording a voltage input from a converter with an arbitrary scale. In this case, the scale should use arbitrary scale factor of the voltage input. For thermocouple or resistance thermometer input, only the position of decimal point can be specified.
- 4) Chart recording range
Set the recording range of chart. Specify 0% position of chart with REC-L and 100% position with REC-H.

Note 2 Valid number of digits

Up to five digits (six digits when including a minus sign) can be set for the upper/lower limit of range, scale and chart recording.

For numeric value settings with a decimal fraction, the lower/upper range should be -30000 to 30000 and the lower/upper scale and chart recording should be -30000 to 99999 with decimals excluded.

- 5) Sensor correction
Measurement value is offset by the specified value. Use this function to adjust the zero point.
- 6) Unit
Arbitrary characters can be set as unit. However, when numeric characters are set, you may find it difficult to distinguish the unit from measured data at data printing.
Up to six digits can be set, and upper two digits are printed only at digital printing.

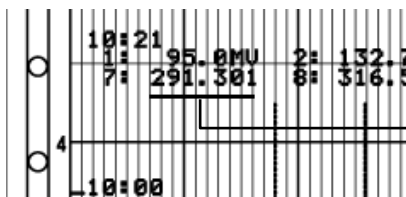

Unit is set to “01”.

Measured data is “291.3” in this case.

- 7) Tag
Tag name can be attached to each channel data.
- 8) Display, trace printing, digital recording/printing, SD card recording ON/OFF
Select ON or OFF for each display/recording.

9) Input filter

The input filter has a function to stabilize the measuring input.

A CR filter is mounted in the measuring circuit. In addition, a software filter (called as "input filter") for the "primary delay computation" is also installed to smooth slight variations of the measuring input. The value for the programming is corresponding to "Time constant: T".

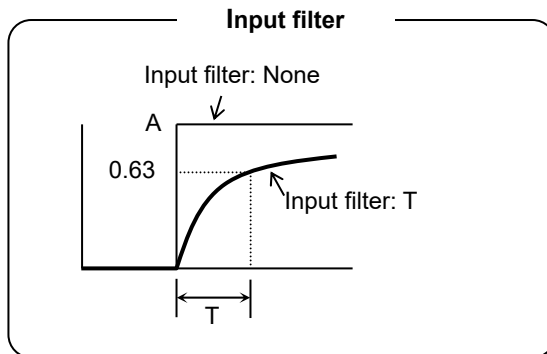

10) Recording deadband

It has an effect to suppress the wobbling pen caused by small fluctuations of measuring input.

The pen does not move until the variation of the measurement input exceeds the set amount.

Setting value: 0.05 mm per 1. At 0, function of the daeadband is invalid.

2. Parameter setting

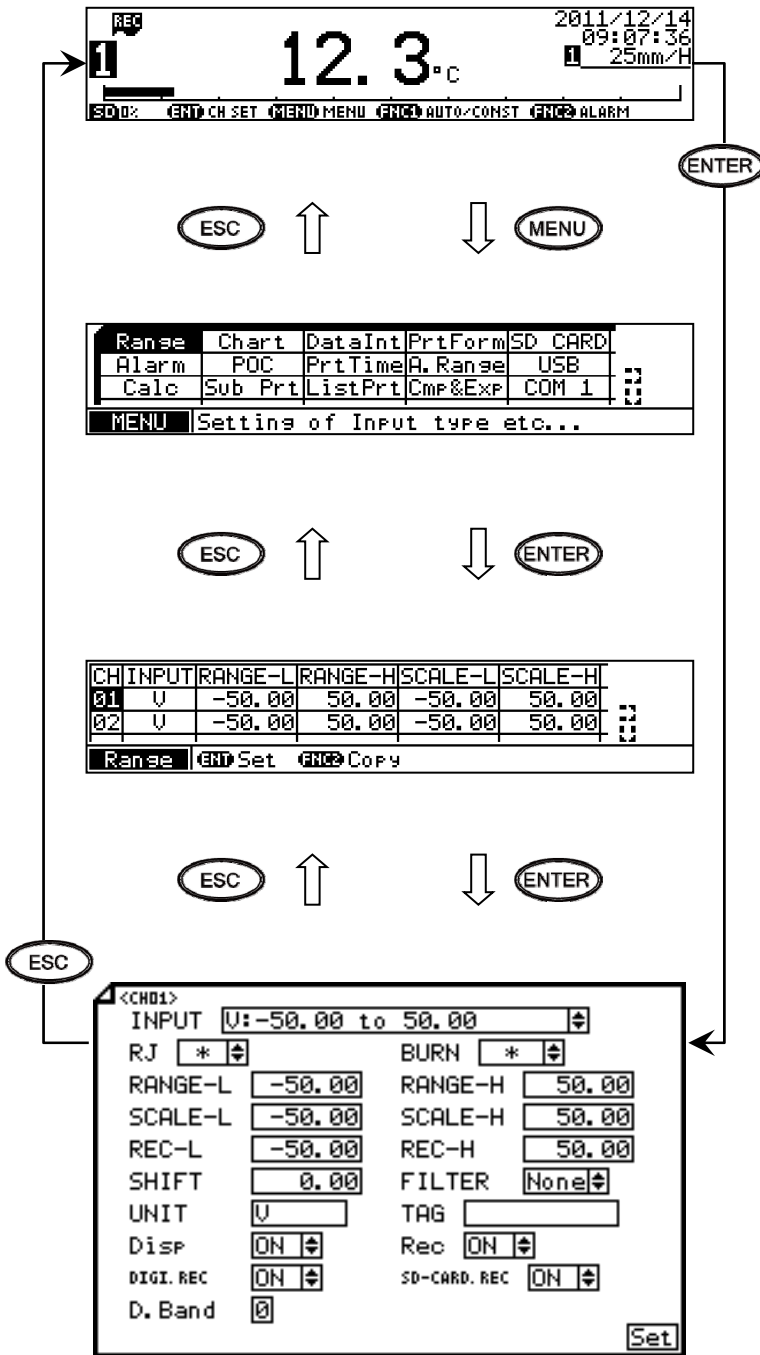

(1) Pressing the **MENU** key displays the menu window (list of setting items).

(2) Select "Range".
(Set contents of all channels will be displayed.)

(3) Move the cursor to the target CH with the **▲/▼** keys and press the **ENTER** key. The cursor does not move to parameters other than CH.
Pressing the **FUNC2** key on this window displays the copy window for input type settings. (See the next page for "Copying settings".)

(4) Move the cursor to a parameter to be set with the **▲/▼/◀/▶** keys.

(5) Press the **ENTER** key to make it available for setting and then select or enter a value.

(6) After completing the settings of this item, move the cursor to **Set**.

(7) Press the **ENTER** key to register the settings (when chart recording is ON, a setting change mark is printed). To cancel the settings, press the **ESC** key.

Note: Actual windows are separated. Use the **▲/▼** keys to scroll and continue settings.

Reference Parameter settings

CH No. is fixed to the one selected from the list of set contents. The input type, RJ, burnout and ON/OFF of each display/recording are set by selecting a value from options with the **▲/▼** keys. The upper/lower limit of range, scale and chart recording, and sensor correction are set by selecting a numeric value at each digit with the **▲/▼** keys. The unit and tag are set by selecting arbitrary characters on the window.

[List of Range setting parameters]

Parameter	Function	Default	Set value
INPUT	Select input type	V: -50.00 to 50.00	V, MV, K, E, J, T, R, S, B, N, U, L, WWRe26, WRe5-26, NiMo-Ni, Platinel2, PtRh40-20, Cr-AuFe, Au/Pt, Pt100, QPt100 (old Pt100), JPt100, Pt50, Pt-Co, UNUSED
RJ	Select whether to use reference junction compensation contact	*	EXT (external), INT (internal)
BURN	Select whether to detect burnout, and action at detection	*	None, UP, DOWN
RANGE-L	The lowest end of measuring range used within the range (measuring range) determined by the input type	-50.00	-30000 to 30000 Up to three digits after decimal point can be set. Example: -30.000
RANGE-H	The highest end of measuring range used within the range (measuring range) determined by the input type	50.00	The same decimal point position is used for the lowest/highest range.
SCALE-L	The lowest end of scaling range specified when selecting the voltage range (mV, etc.) for input type	-50.00	-30000 to 99999 Up to three digits after decimal point can be set. Example: -30.000
SCALE-H	The highest end of scaling range specified when selecting the voltage range (mV, etc.) for input type	50.00	The same decimal point position is used for the lowest/highest scaling range.
REC-L	Lowest end of chart recording (left)	-50.00	-30000 to 99999 Up to three digits after decimal point can be set. Example: -30.000
REC-H	Highest end of chart recording (right)	50.00	The same decimal point position is used for the lowest/highest recording range.
SHIFT	Sensor correction Set offset value to the data after scaling	0.00	-30000 to 99999 Up to three digits after decimal point can be set. Example: -30.000
FILTER	Time constant of input filter (sec).	None	None, 0.5s, 1s, 2s, 3s, 4s, 5s,
UNIT	Set a character string of up to six characters	V	
TAG	Set a character string of up to 10 characters	Not set	
Disp	Select ON or OFF for measured value display	ON	ON, OFF
Rec	Select On or OFF for trace printing	ON	ON, OFF
DIGI.REC	Select On or OFF for digital recording/printing	ON	ON, OFF
SD-CARD.REC	Select On or OFF for SD card recording	ON	ON, OFF
D.Band	Recording deadband	0	0 to 9

3. Copying settings

Pressing the **FUNC2** key on the list of set contents displays the copy window for channel settings.

Move the cursor to the item you want to copy with the **▲/▼/◀/▶** keys.

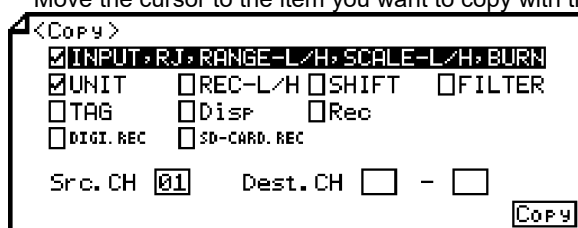

Press the **ENTER** key to check the check box of desired item.

After selecting items to be copied, specify the source and destination. Move the cursor to the source (Src.CH) and select CH with the **▲/▼** keys (forward/reverse) and then press the **ENTER** key to register. When the cursor moves to the destination (Dest.CH), select CH likewise. Settings can be copied to specified channels collectively.

When the destination setting is completed, move the cursor to **Copy** and press the **ENTER** key to start copying.

Note Influence on other settings

When parameters like input type and scale upper/lower limit are changed in "input type settings", it may affect other settings (alarm settings/deadband, etc.).

Please bear this in mind since copying these parameters may also affect other settings.

4. Shortcut for input type settings

Only for "input type settings", a setting window of each channel can be displayed from the measured value display window. On the each display mode, highlight the channel number you want to set with the **▲/▼/◀/▶** keys and press the **ENTER** key. For the case of 1-point display, pressing the **ENTER** key brings the parameter setting window of the displayed channel.

* Copy function is unavailable on a setting window displayed using shortcut.

8-3. Alarm Settings “Alarm”

Various alarm points can be set for measured value of each channel. Up to four alarm points per channel can be set and the type of alarm (upper/lower, diff upper/lower, or rate-of-change upper/lower) can be set to each alarm point arbitrarily. Using the alarm settings, alarm printing, alarm display, status LED indication and relay output can be performed. Alarm output (relay output) provides up to 12 points when option is used.

1. Display and print at alarm activation/reset

When alarm is activated, the “ALM” status LED and measured value of the channel generating the alarm will start flashing.

Pressing the **FUNC2** key displays details of the alarm and a list of active alarms.

Also, “alarm type”, “alarm level” and “alarm activation time” of the alarm generating channel are printed at the far right of chart, and “alarm level” and “alarm reset time” are printed when the alarm is reset.

The maximum number of printing tasks of alarm activation/reset held by the unit is 48. Further printing tasks of alarm activation/reset cannot be accumulated. When 48 is exceeded, ▲mark is printed right at the level.

Example of chart printing at alarm activation

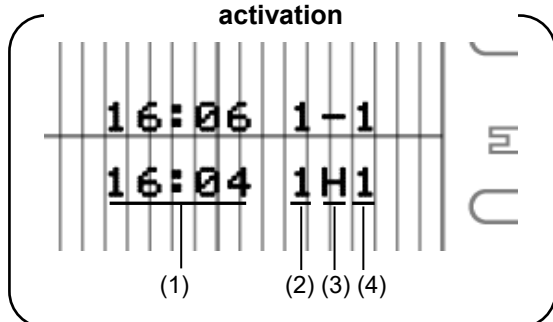

Reset	(1) Time (2) CH (3) – (hyphen) (4) Level
Activated	(1) Time (2) CH (3) Alarm type (4) Level

2. Alarm setting parameters

The alarm function does not work initially since it is not set prior to shipment.

- 1) Alarm point (alarm type and alarm value)
Alarm type (upper/lower, diff upper/lower or rate-of-change upper/lower) and alarm point can be set for up to four levels per channel at arbitrary points.

- 2) Alarm deadband
Alarm is activated when a measured value reaches an alarm value (see right figure). Alarm reset point can be set at a point toward the normal range, and the area between the alarm activation and reset points is called alarm deadband.
The setting range is the same as the scale setting.

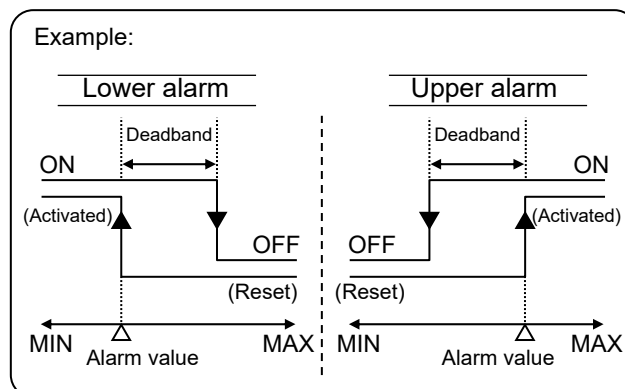

- 3) Compared CH (for diff upper/lower alarm only)
Specify a comparison target CH when using diff upper/lower alarm.
- 4) Reference period (for rate-of-change upper/lower alarm only)
Specify a period for comparing the amount of change.
(See the next section for alarm type.)
- 5) Delay
Output delay time (Delay) can be set for each channel and level. Alarm is activated when a specified delay time passes after alarm condition is detected. If the alarm condition is cleared during the delay period,

alarm will not be activated.

6) Output

Alarm condition (activation/reset) at each alarm point is output from the relay of the specified No. (alarm output terminal No.). This output is not performed initially because it is set to “-“ prior to shipment. Output relay can be specified arbitrarily for each channel and level (from No.1 to 12 relay: optional). When “99” is specified, internal circuit output can be performed instead of relay output. The internal ON/OFF signal can be used as a trigger for SD card recording or mail sending (optional).

7) Output mode (AND/OR)

Select the circuit type (AND/OR) for output. Multiple alarm points can be assigned to one relay No.

AND output:.....Relay turns ON when all the assigned alarm points generate alarm.

OR output:.....Relay turns ON when any of the assigned alarm points generates alarm.

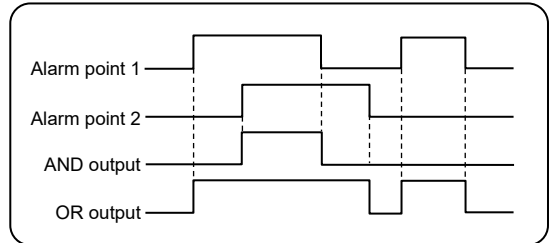

8) Holding/not holding conditions of measured value display, status LED and relay output at alarm activation

When alarm is activated, the measured value and “ALM” start flashing. When the alarm is reset, the measured value stops flashing and “ALM” is turned off (they keep flashing when alarm display and relay output is held).

You can stop flashing of measured value and status LED from the alarm status check window if the alarm has been reset. When remote contact is selected as a reset method, specify the remote contact No. which executes a reset (Hold-EX).

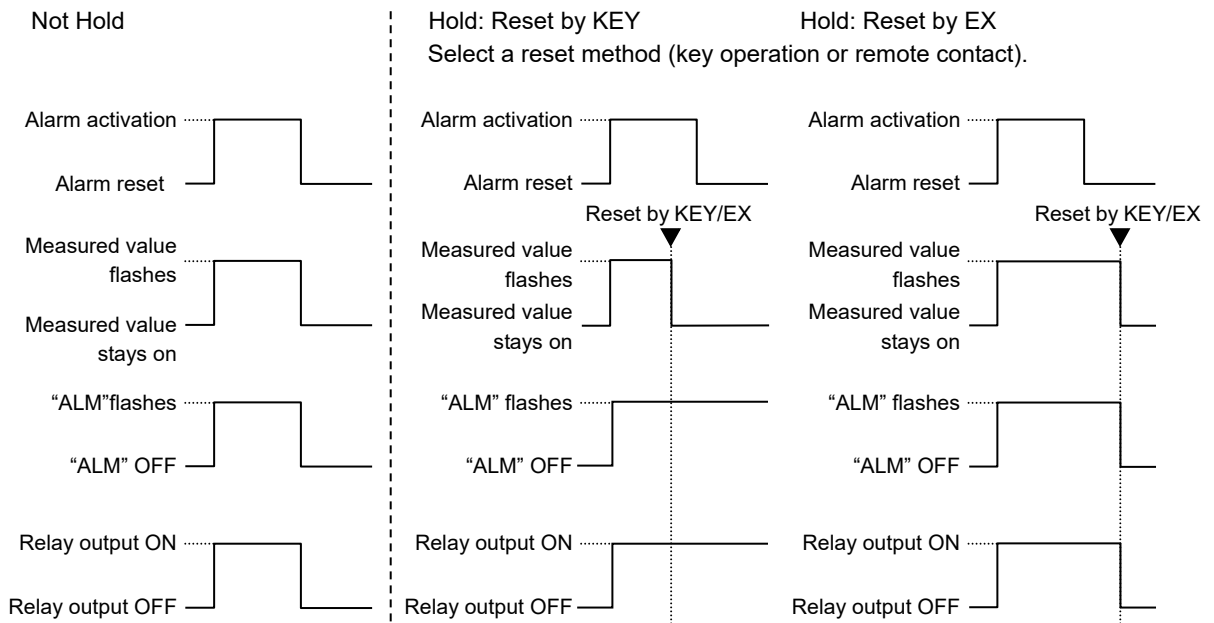

Note Alarm confirmation and output status

The status LED and output cannot be reset while alarm is activated. Even when alarm is reset, the condition of display, status LED and output at alarm activation are held. Specify a reset method for these items.

3. Alarm type

Alarm type can be selected from the following six types for each alarm point.

- 1) Upper limit alarm (H)
Alarm is activated when the measured value of specified channel reaches or exceeds an alarm value.
Set value alarm value, deadband
Activation condition specified CH data \geq alarm value
Reset condition specified CH data $<$ (alarm value $-$ deadband)
- 2) Lower limit alarm (L)
Alarm is activated when the measured value of specified channel reaches or falls below an alarm value.
Set value alarm value, deadband
Activation condition specified CH data \leq alarm value
Reset condition specified CH data $>$ (alarm value $+$ deadband)
- 3) Difference upper limit alarm (B)
Alarm is activated when the difference calculated by subtracting the measured value of compared channel from the measured value of specified channel reaches or exceeds an alarm value.
Set value alarm value, compared CH, deadband
Activation condition (specified CH data $-$ compared CH data) \geq alarm value
Reset condition (specified CH data $-$ compared CH data) $<$ (alarm value $-$ deadband)
- 4) Difference lower limit alarm (S)
Alarm is activated when the difference calculated by subtracting the measured value of compared channel from the measured value of specified channel reaches or falls below an alarm value.
Set value alarm value, compared CH, deadband
Activation condition (specified CH data $-$ compared CH data) \leq alarm value
Reset condition (specified CH data $-$ compared CH data) $>$ (alarm value $+$ deadband)
- 5) Rate-of-change upper limit alarm (U)
Alarm is activated when the measured value variation width of specified channel in the reference period [Δt sec] is at the plus side and equal to or higher than an alarm value.
Set value alarm value (absolute value with any sign), reference period [Δt sec],
 deadband
The reference period is set within the range of 0 to 600.0sec. Alarm judgment cycle is as follows:
0.1sec (Δt is set to 2sec or less)
 $\Delta t/2$ sec (rounding up to whole number)
- 6) Rate-of-change lower limit alarm (D)
Alarm is activated when the measured value variation width of specified channel in the reference period [Δt sec] is at the minus side and equal to or higher than an alarm value.
Set value alarm value (absolute value with any sign), reference period [Δt sec],
 deadband
The reference period is set within the range of 0 to 600.0sec. Alarm judgment cycle is as follows:
0.1sec (Δt is set to 2sec or less)
 $\Delta t/2$ sec (rounding up to whole number)

Rate-of-change alarm

Upper alarm: Variation width per unit time $[\Delta t]$ (PV2 - PV1) is at plus side.

Lower alarm: Variation width per unit time $[\Delta t]$ (PV2 - PV1) is at minus side.

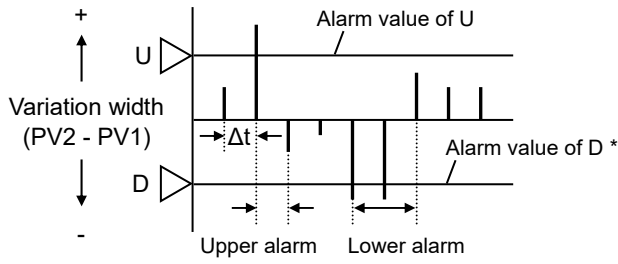

Unit time $[\Delta t] = \text{measuring interval (approx. 0.1sec)} \times \text{measuring count (1 to 20)}$

Differential alarm

(Diff upper alarm)

(Diff lower alarm)

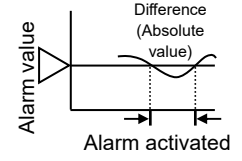
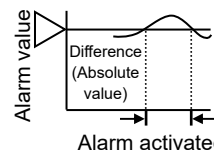

Difference in measured value (absolute value)

\geq alarm value: diff upper alarm activated

Difference in measured value (absolute value)

\leq alarm value: diff lower alarm activated

4. Parameter settings



- (1) Pressing the **MENU** key displays the menu window (list of setting items).



Range	Chart	DataInt	PrtForm	SD CARD
Alarm	POC	PrtTime	A. Range	USB
Calc	Sub Prt	ListPrt	Cmp&Exp	COM 1
MENU Setting of Alarm param				

- (2) Select "Alarm".



Lv1	CH	Mode	Value	D. Band	Comp. CH
01	None	-	-	-	-
02	None	-	-	-	-
Alarm ENT Set FUNC Level FUNC Copy					

- (3) Move the cursor to the target channel with the **▲/▼** keys and press the **ENTER** key. The cursor does not move to parameters other than CH.

Pressing the **FUNC1** key on this window allows you to change the alarm level.

Pressing the **FUNC2** key displays the copy window for alarm settings.



<CH01>

D Level Mode

Value D. Band

Comp. CH Std. TIME

Delay

Relay No. And/Or

[Message No.]

Activation

Reset

Hold-DISP (Alarm display: Hold or NotHold)

Hold-OUT (Relay output: Hold or NotHold)

Hold-EX (Setting of EX No. for Hold reset)

Set

- (4) Move the cursor to the parameter to be set with the **▲/▼/◀/▶** keys.
- (5) Press the **ENTER** key to make it available for setting and then select or enter a value.
- (6) After completing the settings of this item, move the cursor to **Set**.
- (7) Press the **ENTER** key to register the settings (when chart recording is ON, a setting change mark is printed). To cancel the settings, press the **ESC** key.

Note: Actual windows are separated. Use the **▲/▼** keys to scroll and continue settings.

Note Relation with the decimal point position of scale set value

The decimal point position of alarm value/deadband is linked to that of scale set value. Therefore, when the decimal point position of scale is changed in "8-2. Input Type Settings", the decimal point position of alarm value/deadband will also be changed. Also, alarm deadband is set to an absolute value.

[List of Alarm setting parameters]

Parameter	Function	Default	Set value
Level	Select level for setting		1 to 4
Mode	Select alarm type	None	None, H (upper), L (lower), B (diff upper), S (diff lower), U (rate-of change upper), D (rate-of-change lower)
Value	Set alarm judgment value	*	-30000 to 99999 Decimal point position is the same as scale setting. For rate-of-change alarm, use absolute value.
D.Band	Set alarm deadband	*	0 to 99999 Decimal point position is the same as scale setting.
Comp.CH	Set CH (reference CH) compared with the setting CH (Diff upper/lower alarm only)	*	1 to 4 “-“ Not set
Std.TIME	Set reference period for calculating variation width (rate-of-change upper/lower alarm only)	*	0 to 600.0 Set period can be narrower than measuring interval. In this case, alarm judgment is made using the measuring interval.
Delay	Set delay time to output after alarm detection	*	0 to 6000 Minimum set value is 1sec.
Relay No.	Specify output relay No.	*	- (No output), 99 (internal circuit output), 1 to 12
And/Or	Select circuit type for output	*	And, Or
Message No. Activation	Specify message No. printed at alarm activation	*	- (Message not printed at alarm activation), 1 to 20
Message No. Reset	Specify message No. printed at alarm reset	*	- (Message not printed at alarm reset), 1 to 20
Hold-DISP	Select whether to hold the status of display and “ALM” status LED at alarm activation	*	Not Hold, Hold:Reset by KEY (hold until reset by key operation) Hold:Reset by EX (hold until reset by remote contact)
Hold-OUT	Select whether to hold the status of alarm output at alarm activation	*	Not Hold, Hold:Reset by KEY (hold until reset by key operation) Hold:Reset by EX (hold until reset by remote contact)
Hold-EX	Specify remote contact No. used when “Hold:Reset by EX” is selected for “Hold-DISP” or “Hold-OUT”	*	- (Not used), 1 to 10 If alarm condition is cleared, on-hold alarm output status is reset when the specified remote contact No. turns ON.

5. Copying settings

Pressing the **FUNC2** key on the list of alarm set contents displays the copy window for alarm settings. Move the cursor to the alarm level you want to copy with the **▲/▼/◀/▶** keys.



Press the **ENTER** key to check the check box of desired alarm level.

After selecting alarm levels to be copied, specify the source and destination. Move the cursor to the source (Src.CH) and select CH with the **▲/▼** keys (forward/reverse) and then press the **ENTER** key to register. When the cursor moves to the destination (Dest.CH), select CH likewise. Settings can be copied to specified channels collectively.

When the destination setting is completed, move the cursor to **Copy** and press the **ENTER** key to start copying.

Reference About alarm level

A level selected for copying “alarm settings” includes all the parameters set for the level.

6. Checking alarm status

You can check if alarm is activated on the measured value display window which is normally displayed. However, to check the detail of activated alarm (alarm type, level, etc.), press the **(FUNC2)** key on the measured value display window to open the alarm status check window.

The alarm status check window consists of the alarm status check window per channel, calendar timer ON/OFF check window and fail output status check window. Use the **◀/▶** keys to switch the window.

- Per-channel alarm status check window

CH	DATA	Lv1	Lv2	Lv3	Lv4
01	12.34	H/Hold	H/Hold	H/Hold	H/Hold
02	2.0	H/Hold	L		

ALM Chk **(FUNC1)** Reset **(FUNC2)** Update 09:48:38

Select the channel you want to check.

The cursor does not move to parameters other than CH.

The current alarm status is listed on the window.

For a channel to which the alarm output and display are set to "Hold", information during alarm activation (measured value and alarm type) is displayed even after the alarm condition is cleared. At this time, "Hold" is shown on the window.

When alarm condition is cleared on the channel selecting "Hold" for alarm output and display and "KEY" as a reset method (Hold:Reset by KEY), select the channel with the **▲/▼** keys and press the **(FUNC1)** key to reset the Hold status.

This alarm status check window contains the information obtained at the time the **(FUNC2)** key is pressed on the measured value display window. To view the latest information, press the **(FUNC2)** key on the alarm status check window.

You can also change "alarm settings" from this window. When a CH No. is selected by the **(ENTER)** key, the setting window of alarm parameters will be displayed.

- Calendar timer ON/OFF check window

No.	Timer ON	Timer OFF
01	2010/07/01 10:30	2010/07/01 15:30

ALM Chk **(FUNC1)** Reset

This window shows the timer ON No. (set time has already passed), set time (Timer ON) and scheduled reset time (Timer OFF).

Pressing the **(FUNC1)** key can reset the Timer ON status.

- Fail output status check window

Information of the Fail		
[Chart End]	[Burn]	
[SD Card]	[Battery]	[System Error]

ALM Chk

This window shows a failed status (chart end, disconnection of input, SD card capacity low, backup battery level low or other system error).

* To enable the above display, you need to select "LCD" for each item according to "8-22. Fail Output Settings".

8-4. Calculation Settings “Calc”

Configure calculation settings to perform arbitrary calculation for each individual channel. Each calculation is performed at the same intervals as input.

Data (including communications input) is processed according to the calculation settings except when the "calculation type (Kind)" is set to "None". The processed data is displayed/recorded as each channel data. Also, alarm judgment is made on the processed data.

There are 16 types of calculation including "None". When you select "Formula" or "BrokenLine", you need to set corresponding parameters described in "8-5. Formula Settings" or "8-6. Broken Line Approximation Table Settings".

1. Calculation types and set parameters

Kind	Formula	Set parameter
None	None	None
Arithmetic 1 (MUL)	$Ax + By + Cxy + D$ A, B, C, D: constant x, y: channel data	Decimal point position for result Constant (A, B, C, D) Channel No. of data (x, y)
Arithmetic 2 (DIV) *1	$Ax \div y + B$ A, B: constant x, y: channel data	Decimal point position for result Constant (A, B) Channel No. of data (x, y)
Natural logarithm (LOGe)	$\text{LOG}e^x$ x: channel data	Decimal point position for result Channel No. of data (x)
Common logarithm (LOG10)	$\text{LOG}10x$ x: channel data	Decimal point position for result Channel No. of data (x)
Exponent (Power)	e^x x: channel data	Decimal point position for result Channel No. of data (x)
Extraction of square root (Root) *2	$(Ss - Sz) \sqrt{\frac{Rx - Rz}{Rs - Rz}} + Sz$ Rx: channel data (input voltage, etc.) Rs: range upper limit Rz: range lower limit Ss: scale upper limit Sz: scale lower limit	Decimal point position for result Channel No. of data (Rx)
Humidity	Calculated from measured value of dry bulb (x) and wet bulb (y) using relative humidity table x, y: channel data	Decimal point position for result Channel No. of data (x, y)
Max value (High-Peak)	Maximum measured value (x) in an interval	Decimal point position for result Interval Start time Channel No. of measured value (x)
Min value (Low-Peak)	Minimum measured value (x) in an interval	
Avg value (Avarage)	Average measured value (x) in an interval	
Absolute value (ABS)	x x: channel data	Decimal point position for result Channel No. of data (x)
Integration (INT)	See "8-4.4. Integration"	
COM.Input	Communications input data (last updated communications input data regardless of communication type) Preset calculation cannot be performed for communications input data, but calculation using "Formula" is available.	Decimal point position for result Data communications channel No. (Reference No. is assigned to each CH.)
Formula	Arbitrarily entered formula	Decimal point position for result Formula (interval, start time, unit of integration* and integration reset method* and integration reset by remote contact ON*) * These become effective when "integration" is specified in a formula.
Broken line approximation (BrokenLine)		Decimal point position for result Broken line approximation table Channel No. of data (x)

*1: If a measured value y is 0, the following value is obtained depending on Ax value.

$Ax > 0$: OVER $Ax = 0$: 0 $Ax \leq 0$: -OVER

*2: This formula is used when the measured input voltage (Rx) is 1% or more of the set range (Rs – Rz).

When it is less than 1%, the scale lower limit (Sz) is used.

2. Channels specifying calculation

For channels specifying calculation, data after processing the specified calculation is recorded or displayed.

3. Calculating max/min/avg value

- 1) Calculation reset
Calculation is reset automatically at specified intervals. Therefore the maximum, minimum and average values are calculated in each interval.

- 2) Start time of calculation
This is valid for the first calculation after setting only. Calculation is not performed and waited until start time. The calculated data during this waiting period is invalid.

4. Integration

Integration operation can be processed on measured value of each channel and the result can be displayed/recorded.

For a channel No. selecting integration, an alarm value is set for calculated (integrated) value.

The data (calculation result) of a calculation set channel is obtained using the following formula.

$$INT_n = INT_{n-1} + \frac{(PV_n + PV_{n-1}) \times (T_n - T_{n-1})}{2} \div \text{Time Unit}$$

INT_n: Integration value

PV_n: Current measured value *1

T_n: Current measurement time [sec]

Time Unit: Unit of time

INT_{n-1}: Last integration value

PV_{n-1}: Last measured value *1

T_{n-1}: Last measurement time [sec]

*1: When the scale width is exceeded, the value at the maximum/minimum scale is used.

- 1) Resetting integration
 - (1) Reset by remote contact
When using remote contacts (optional), a start and reset of integration can be executed with a remote contact signal. When a calculation is started by a remote contact reset, integration value will be reset at set intervals.
(See "13-1. External Operation Settings".)
 - (2) Reset after specified interval
After integration operation is started, the integration value is reset automatically after a specified interval and then the operation is restarted.

- 2) Max integration value
The maximum integration value is 99999 (it actually depends on the decimal point position of result: 99.999 to 99999). If integration value exceeds the maximum value, it will be reset to 0 and the integration operation continues.

5. Parameter settings

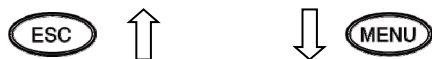

- (1) Pressing the **MENU** key displays the menu window (list of setting items).

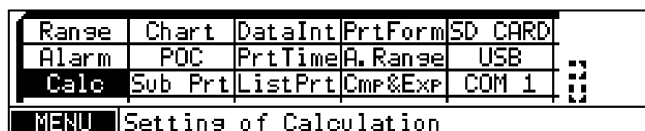

- (2) Select "Calc".



- (3) Move the cursor to the target channel with the **▲/▼** keys and press the **ENTER** key. The cursor does not move to parameters other than CH.

Pressing the **FUNC1** key on this window displays the integration reset window. Also, pressing the **FUNC2** key displays the copy window for calculation settings.

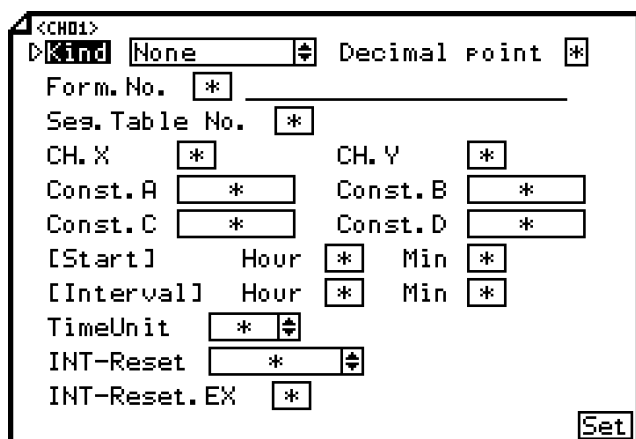

- (4) Move the cursor to the parameter to be set with the **▲/▼/◀/▶** keys.
 (5) Press the **ENTER** key to make it available for setting and then select or enter a value.
 (6) After completing the settings of this item, move the cursor to **Set**.
 (7) Press the **ENTER** key to register the settings (when chart recording is ON, a setting change mark is printed). To cancel the settings, press the **ESC** key.

Note: Actual windows are separated. Use the **▲/▼** keys to scroll and continue settings.

[List of Calc setting parameters]

Parameter	Function	Default	Set value
Kind	Select calculation type	None	None (No calculation), Root (square root), LOGe (natural logarithm), LOG10 (common logarithm), INT (integration), Humidity (humidity/temperature calculation) COM.Input (data communications input), MUL (arithmetic 1), DIV (arithmetic 2), High-Peak (max value), Low-Peak (min value), Average (average calculation), Power (exponent), ABS (absolute value calculation) Formula, BrokenLine (broken line approximation)
Decimal point	Set decimal point position for result	*	0 to 3
Form.No.	Specify formula No. when "Formula" is selected for Kind	*	- (None), 1 to 12
Seg.Table No.	Specify broken line table No. when "BrokenLine" is selected for Kind	*	- (None), 1 to 6
CH.X	Specify CH for X data used by each calculation	*	- (None), 1 to 4
CH.Y	Specify CH for Y data used by each calculation	*	- (None), 1 to 4
Const.A	Set calculation constant A when arithmetic 1 or 2 is selected for Kind	*	-30000 to 99999 Up to three digits after decimal point can be set. Example: -30.000
Const.B	Set calculation constant B when arithmetic 1 or 2 is selected for Kind	*	-30000 to 99999 Up to three digits after decimal point can be set. Example: -30.000
Const.C	Set calculation constant C when arithmetic 1 is selected for Kind	*	-30000 to 99999 Up to three digits after decimal point can be set. Example: -30.000
Const.D	Set calculation constant D when arithmetic 1 is selected for Kind	*	-30000 to 99999 Up to three digits after decimal point can be set. Example: -30.000
[Start]	Set calculation start time Calculation is waited until set time (data during the waiting period is invalid).	*	- (None), 00 : 00 to 23 : 59 When "-" is set, following operations are performed. Integration: Operated by external reset Formula: Operated at power-on or immediately after setting is made
[Interval]	Set calculation interval For calculations using integration, integration value is reset at set intervals.	*	- (None), 00 : 00 to 24 : 59 Setting "-" or "00 : 00" disables interval.
TimeUnit	Unit of integration time	*	Hour, Min, Sec
INT-Reset	Set integration reset method for calculations using integration	*	None (reset not performed), Interval (specified interval), EX (All) (all reset by remote contact), EX (individual reset by remote contact)
INT-Reset.EX	Specify remote contact No. used when "EX" is selected for "INT-Reset"	*	- (None), 1 to 10

8-5. Formula Settings “Formula”

Set a formula used when “Formula” is selected for Kind in "calculation settings".

Up to 12 formulas, which are shared by all channels, can be registered using a character string consisting of 50 characters at maximum.

1. Calculation type

Arithmetic operation

Four arithmetic operations are performed.

	Symbol	Example	Note
Addition	+	$X + Y$	
Subtraction	-	$X - Y$	
Multiplication	*	$X * Y$	
Division	/	X / Y	
Remainder	%	$X \% Y$	
Power	^	$X ^ Y$	

* X and Y represent formula or numeric value.

Comparison operation

Result is expressed by 1 (true) or 0 (false).

	Symbol	Example	Note
Equal	==	$X == Y$	
Unequal	!=	$X != Y$	
Greater than	>>	$X >> Y$	
Less than	<<	$X << Y$	
Greater than or equal to	>=	$X >= Y$	
Less than or equal to	<=	$X <= Y$	

* X and Y represent formula or numeric value.

Logical operation

Logical operation is performed and either 1 or 0 is returned as a result.

	Symbol	Example	Note
Logical AND	AND	$X \text{ AND } Y$	Parenthesize formula target
Logical OR	OR	$X \text{ OR } Y$	Parenthesize formula target
Exclusive OR	XOR	$X \text{ XOR } Y$	Parenthesize formula target
Negation	NOT	NOT (X)	Parenthesize negation target

* X and Y represent formula or numeric value. X and Y should indicate 0 or 1.

General calculation functions

Function calculation is performed.

	Symbol	Example	Note
Round up to whole number	CEL	CEL (X)	
Round down to whole number	FLR	FLR (X)	
Absolute value	ABS	ABS (X)	
Square root	SQR	SQR (X)	
Power of e	EXP	EXP (X)	
Natural logarithm (bottom e)	LOG	LOG (X)	
Common logarithm (bottom 10)	LOG10	LOG10 (X)	

* X represents formula or numeric value.

Channel data calculation functions

Function calculation is performed.

An error occurs when measured data contains error data (\pm OVER, etc.).

	Symbol	Example	Note
Input data	CH	CH(X)	X: Channel No.
Calculation result	PCH	PCH(X)	
Previous result	OCH	OCH(X)	Data at the last scan (0.1sec before)
Integration	ITG	ITG(X)	See "2. Integration"
24-hour integration	ITG24	ITG24(X)	See "2. Integration"
F value	FV	FV(X#T#Z#R)	See "3. F value"
Relative humidity	RH	RH(D#W)	See "4. Relative humidity"
Dew-point temp	DEW	DEW(T#H)	See "5. Dew-point temperature"
Moving average	AVE	AVE(X#T)	See "6. Moving average"
Past data	OLD	OLD(X#T)	See "7. Past data"
First-order lag filter	IIR	IIR(X#T)	See "8. First-order lag filter"
Increment per unit time	PLS	PLS(X#T)	See "9. Increment per unit time"

* X represents channel number.

- * When a formula specifies a calculation result in it and the specified channel No. is larger than the calculating channel No., the last calculation result will be used.

Function to get system information

	Symbol	Example	Note
SD card remaining amount	SD	SD(A)	A = unit of remaining amount 0: %

Other functions

	Symbol	Example	Note
Wind display	AZI	AZI(A)	See "10. Wind display"
Broken line approximation	LIC	LIC(A)	See "11. Broken line approximation"

2. Integration

The ITG or ITG24 function is used to perform integration operation.

The integration function cannot be used more than once in a formula. Ignoring this causes erroneous calculation. Combining with another type of calculation is possible.

Example: ~~ITG(1)+ITG(2)~~ ~~ITG24(1)-ITG(1)~~ (ITG(1) / 100)

Integration value is reset at every start time and intervals specified in "calculation settings" for ITG function, and at every start time for ITG24 function.

- 1) Normal integration
 Integration value is reset at every reference time and interval.
 Entering a formula
 ITG(X)
 X: Channel No. of integration target

Calculation detail

$$D_n = D_{n-1} + \{(PV_n + PV_{n-1}) \times (T_n - T_{n-1})\} \div 2$$
 D_n: Integration result D_{n-1}: Last integration result
 PV_n: Integration target data PV_{n-1}: Last integration target data
 T_n: Calculation time T_{n-1}: Last calculation time

If error data (±OVER, etc.) is included, calculation will not be performed and the last result will be valid.

- 2) 24-hour integration
 Integration value is reset only at reference time (start time).

Entering a formula
 ITG24(X)
 X: Channel No. of integration target

Calculation detail is the same as normal integration.

3. F value

Entering a formula
 FV(X#To#Z#R)
 X: Channel No. of calculation target, To: Reference temperature for F value calculation, Z: Z value, R: Start temperature for F value calculation

F value is obtained from the following calculation.
 $\int 10^A dt$ where $A = (T - To) \div Z$ T: Calculation target channel data

When T value exceeds R value, F value will be reset to 0.

4. Relative humidity

Entering a formula
 RH(D#W)
 D: Channel No. of dry bulb temperature, W: Channel No. of wet bulb temperature

Relative humidity is obtained from the following formula.

$$((B - 0.000662 \times 1013.0 \times (Ddata - Wdata)) \div A) \times 100$$
 A: Dry bulb saturated water vapor pressure, B: Wet bulb saturated water vapor pressure, Ddata: Dry bulb temperature, Wdata: Wet bulb temperature

The following formula is used to obtain a value of saturated water vapor pressure.

$$6.1121 \times \text{EXP}((17.502 \times T) \div (240.9 + T))$$
 T: Temperature

5. Dew-point temperature

Entering a formula

DEW(T#H)

T: Channel No. of temperature data, H: Channel No. of relative humidity

Dew-point temperature is obtained from the following calculation.

t: Temperature data

h: Relative humidity data

D: Dew-point temperature

$$(1) K = t + 273.15$$

(2) When $t \geq 0$:

$$W = \text{EXP}(-5800.2206 / K + 1.3914993 + K \times (-0.048640239 + K \times (0.41764768E-4 - 0.14452093E-7 \times K)) + 6.5459673 \times \text{LOG}(K)) / 1000$$

When $t < 0$:

$$W = \text{EXP}(-5674.5359 / K + 6.3925247 + K \times (-9.677843E-3 + K \times (0.62215701E-6 + K \times (0.20747825E-8 - 9.484024E-13 \times K))) + 4.1635019 \times \text{LOG}(K)) / 1000$$

$$(3) S = W \times h / 100$$

$$(4) P = S \times 1000$$

$$(5) Y = \text{LOG}(P)$$

(6) When $P \geq 611.2$:

$$D = -77.199 + Y \times (13.198 + Y \times (-0.63772 + 0.071098 \times Y))$$

When $P < 611.2$:

$$D = -60.662 + Y \times (7.4624 + Y \times (0.20594 + 0.016321 \times Y))$$

6. Moving average

Entering a formula

AVE(X#T)

X: Data channel No., T: Time-line range (x 0.1sec)

An average value in the past T seconds is calculated.

	AVE
Sampling period	0.1sec
T range	1 to 10 (x 0.1sec)

7. Past data

Entering a formula

OLD(X#T)

X: Data channel No., T: Backward time (x 0.1sec)

Data obtained T seconds before is acquired.

	OLD
Sampling period	0.1sec
T range	1 to 10(x 0.1sec)

8. First-order lag filter

Entering a formula

IIR(X#T)

X: Data channel No., T: Time constant (x 0.1 sec)

First-order lag filter calculation is processed on the channel X data.

Calculation detail

$$\{dt \div (dt + t)\} \times (x - d) + d$$

dt: Sampling time

t: Time constant

x: Current value of channel X

d: Last calculation result

9. Increment per unit time

Entering a formula

PLS(X#T)

X: Data channel No., T: Unit time (1 to 10 x 0.1sec)

Increment per unit time is calculated. Specify a channel selecting integration operation for X.

When using PLS function, the data will be invalid when a reset of integration value occurs at a set time or by another reason except overflow (because the same process as overflow reset is performed internally). Formulate the operation in consideration of reset of integration value.

10. Wind display

Entering a formula

AZI(A)

A: Wind data

Wind display is made by converting numeric data into direction.

See the following table for the relation between wind data and displayed direction.

When A has a decimal fraction, the nearest direction will be displayed. Example: 1.2 → NNE

A	Display	A	Display
•	•	8	S
•	•	9	SSW
•	•	10	SW
-3	WNW	11	WSW
-2	NW	12	W
-1	NNW	13	WNW
0	N	14	NW
1	NNE	15	NNW
2	NE	16	N
3	ENE	17	NNE
4	E	18	NE
5	ESE	•	•
6	SE	•	•
7	SSE	•	•

Also, the scale of the channel selecting wind display as calculation type uses wind scale.

11. Broken line approximation

Entering a formula

LIC(X#A)

X: Data channel No.

A: Defined broken line approximation table No.

"Broken line approximation" can be added in a formula, and the first-order approximation can be performed for up to 30 broken lines.

Broken line is defined separately using up to six tables, and the table No. is specified in a formula (see "8-6. Broken Line Approximation Table Settings").

Calculation is performed using the following formula according to the specified table parameters.

$$A_n < X_1 < A_{n+1} \{ (B_{n+1} - B_n) / (A_{n+1} - A_n) \} \times (X_1 - A_n) + B_n$$

12. Examples of combining different operations

- **(CH(1) * 3 - 20) / 6**
("Channel 1 raw data" x 3 - 20) ÷ 6
- **(CH(1) + CH(2)) << 300**
Result will be 1 when the sum of channel 1 and channel 2 raw data is smaller than 300.
- **ABS(CH(1)) >= 50**
Result will be 1 when the absolute value of channel 1 is greater than or equal to 50.
- **(PCH(1) >= 100) AND (PCH(2) <= 50)**
Result will be 1 when the channel 1 data is greater than or equal to 100, and the channel 2 data is less than or equal to 50.

Note Combination of functions

Following functions cannot be combined together. Combining these functions causes calculation error.

ITG, ITG24, AVE, AVEH, OLD, OLDH, IIR

Example of formula which delivers a false result: AVE(OLD(1#10)#60)

13. Parameter settings



(1) Pressing the **MENU** key displays the menu window (list of setting items).

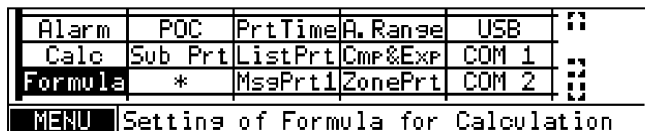

(2) Select "Formula".

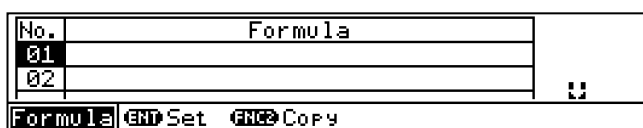

(3) Move the cursor to the target formula No. with the **▲/▼** keys and press the **ENTER** key. The cursor does not move to parameters other than formula No. Also, pressing the **FUNC2** key on this window displays the copy window for formula settings.

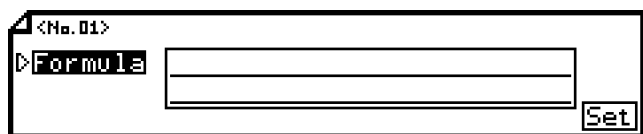

(4) Press the **ENTER** key to make it available for setting and then enter a formula.
 (5) After completing the setting of this item, move the cursor to **Set**.
 (6) Press the **ENTER** key to register the setting (when chart recording is ON, a setting change mark is printed). To cancel the setting, press the **ESC** key.

[Formula setting parameter]

Parameter	Function	Default	Set value
Formula	Set formula used when "Formula" is selected as "calculation type" using up to 50 characters	Not set	

8-6. Broken Line Approximation Table Settings “Seg.Tbl”

Set the table used when “BrokenLine” is selected as calculation type.

Up to six tables can be set, and up to 30 points can be set to each table. For channels selecting “BrokenLine” as calculation type, a table can be selected individually from six options.



Calc	Sub Prt	ListPrt	Cmp&Exp	COM 1	↕
Formula	*	MssPrt1	ZonePrt	COM 2	↕
Seg. Tbl	*	MssPrt2	*	*	↕

MENU Settings of Segment Table



Table No. 01	No.	X	Y	
	01	0	0	
	02	0	0	

Seg. Tbl (ENT) Set (FUNC) TableNo. (FUNC) TableCopy



<No. 01>

X.Dot 0 Y.Dot 0

X-01 0 Y-01 0

X-02 0 Y-02 0

X-29 0 Y-29 0

X-30 0 Y-30 0

Set

(1) Pressing the **MENU** key displays the menu window (list of setting items).

(2) Select “Seg.Tbl”.

(3) Pressing the **FUNC1** key advances the table number. Press the **ENTER** key to select the target table.

Also, pressing the **FUNC2** key on this window displays the copy window for table settings.

(4) Move the cursor to the parameter to be set with the **▲/▼/◀/▶** keys.

(5) Press the **ENTER** key to make it available for setting and then enter a value.

(6) After completing the settings of this item, move the cursor to **Set**.

(7) Press the **ENTER** key to register the settings (when chart recording is ON, a setting change mark is printed). To cancel the settings, press the **ESC** key.

[List of Seg.Tbl setting parameters]

Parameter	Function	Default	Set value
X.Dot	Set decimal point position of X axis factor	0	0 to 3
Y.Dot	Set decimal point position of Y axis factor	0	0 to 3
X-01 to X-30	Set X1 to X30 of broken line approximation table	-	- (Not set), -30000 to 99999 When “-” is selected, subsequent X factor settings will be disabled.
Y-01 to Y-30	Set Y1 to Y30 of broken line approximation table	-	- (Not set), -30000 to 99999 When “-” is selected, subsequent Y factor settings will be disabled.

8-7. Chart Speed Settings “Chart”

Set the chart speed. When using remote contacts (optional), see also “13-1. External Operation Settings”.

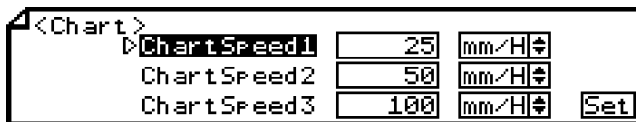
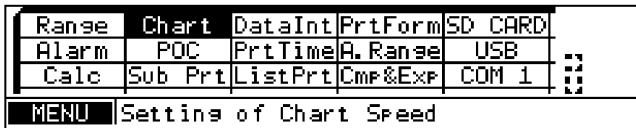

Note: “ChartSpeed2” and “ChartSpeed3” are displayed only when remote contacts (optional) are used.

(1) Pressing the **MENU** key displays the menu window (list of setting items).

(2) Select “Chart”.

(3) 3-speed setting is available only when using remote contacts (optional). Move the cursor to the chart speed to be set, and press the **ENTER** key to make it available for setting and then enter a value.

Set a desired speed within the range of (unit: 1mm) 1 to 600mm/H or 1 to 200mm/M, but 12.5mm/H is an exception.

(4) After completing the settings of this item, move the cursor to **Set**.

(5) Press the **ENTER** key to register the settings (when chart recording is ON, a setting change mark is printed). To cancel the settings, press the **ESC** key.

[List of Chart setting parameters]

Parameter	Function	Default	Set value
ChartSpeed1	Set chart speed 1	25	1 to 600 (mm/H) 1 to 200 (mm/M)
ChartSpeed1 unit	Select unit of chart speed 1	Mm/H	mm/H, mm/M
ChartSpeed2 (optional)	Set chart speed 2	25	1 to 600 (mm/H) 1 to 200 (mm/M)
ChartSpeed2 unit	Select unit of chart speed 2	mm/H	mm/H, mm/M
ChartSpeed3 (optional)	Set chart speed 3	25	1 to 600 (mm/H) 1 to 200 (mm/M)
ChartSpeed3 unit	Select unit of chart speed 3	Mm/H	mm/H, mm/M

Note 1 Setting a speed at 150mm/H or higher

All types of printing excluding time line printing, power-on printing, data printing, list printing and setting change mark will be disabled. (See “6-3.3. Restrictions on recording”.)

8-8. Time axis synchronization "POC"

This function is applicable to multiple pen type (2-pen, 3-pen and 4-pen types).

The function adjusts time axis gaps between the each pen and print at the same moment on the chart.

1. Pen interval

In the standard printings, data at the same moment are not able to print on the chart paper with time axis due to the time axis gaps between the each pen. When the time axis synchronization is ON, the data for the gaps are stored in memory and when the chart paper is fed to the printing start point of the 1st pen, the stored data are printed. The printing except for the 1st pen are not executed at the real time, however there will be no time axis gaps the on the chart.

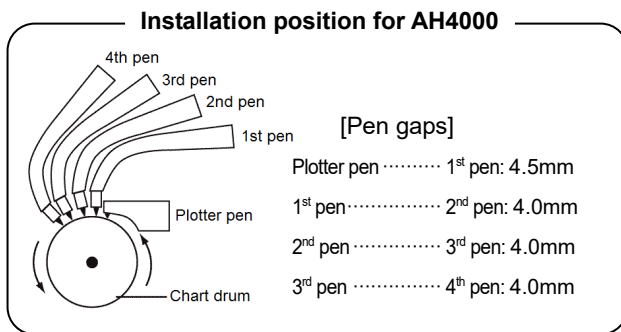

Reference

Switching of time axis synchronization ON/OFF

- (1) Time axis synchronization is OFF at the default setting.
- (2) Turn OFF the time axis synchronization to observe current indication and execute input adjustment.

<Printing EX. 1> Time axis synchronization not executed

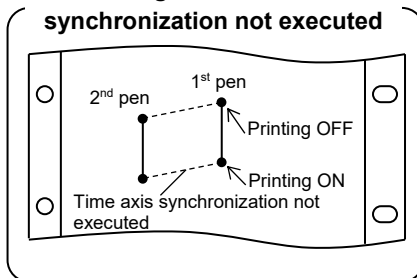

<Printing EX. 2> Printing operation ON/OFF at time axis synchronization executed

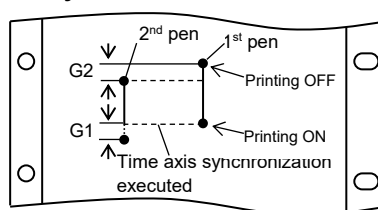

When the printing is ON, 2nd pen stores data of gaps (G1) to 1st pen in memory and start printing on same time axis as 1st pen. When the printing is OFF, the data of gaps (G2) to 1st pen are deleted.

<Printing EX. 3> Power supply ON/OFF at time axis synchronization executed

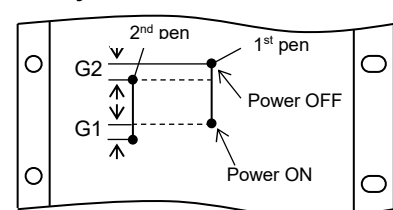

When the power supply is ON, 2nd pen prints data of gaps (G1: stored data in memory prior to the power OFF) to 1st pen. While the Power supply is OFF, data of gaps to 1st pen (G2) is stored.

2. Operation at turning on the power supply

When using the recorder as first time, 2nd pen, 3rd pen and 4th pen wait at left side until the chart is fed to the 1st pen starting time axis.

Using the recorder after the first time (power OFF to power ON), 2nd pen, 3rd pen, and 4th pen move as the 1st pen, however until they reach the 1st pen starting time axis, they print previous (before power OFF) data. Subsequently, printing is done at previous data not real-time data.

Note Change of the chart speed

Changing the setting of the chart speed clears memory of 2nd pen, 3rd pen and 4th pen. Therefore, 2nd pen, 3rd pen and 4th pen wait at left side until they reach 1st pen starting time axis.

3. Parameter settings



(1) Pressing the **MENU** key displays the menu window (list of setting items).

(2) Select "POC".

(3) Press **ENTER** key to enable settings then select set value.

(4) After setting of this item is finished, move the cursor to **Set**.

(5) Press the **ENTER** key to register the settings (when chart recording is ON, a setting change mark is printed). To cancel the settings, press the **ESC** key.

[List of POC setting parameters]

Parameter	Function	Default	Set value
POC ON/OFF	Select time axis synchronization ON/OFF.	OFF	OFF(without synchronization), ON(with synchronization)

Reference Time axis synchronization mark

Print marks listed below when switching ON or OFF.

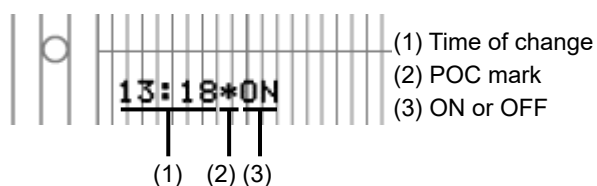

8-9. Subtract Printing Settings “Sub Prt”

Subtract printing can be set using either of the following method: (1) use channel C data as difference between channel A and channel B, or (2) use channel E data as difference between channel D and a reference value. Channels used for subtract printing are also used for normal measurement. Therefore, for 4 pen type specification, channel 1 to 4 can be used for subtract printing.

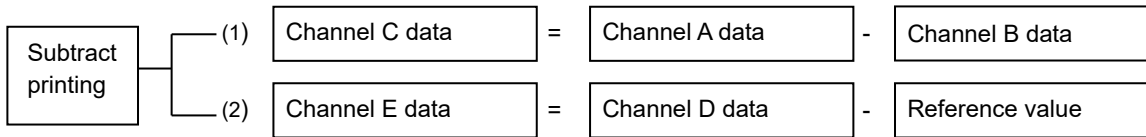

* For the case of type (1) above, the decimal point position depends on the channel data of minuend.

1. Setting chart recording range

Make sure to perform input type settings described in “8-2. Input Type Settings” before performing subtract printing (see **Note 3**).

“Difference value” is recorded as channel C or E data in subtract printing. Therefore, the chart recording range for subtract printing is required and it is set by specifying the upper and lower limits. Also, unit is set when needed. It is necessary to estimate “difference value” beforehand to set the chart recording range.

Example of subtract printing between 2 channels

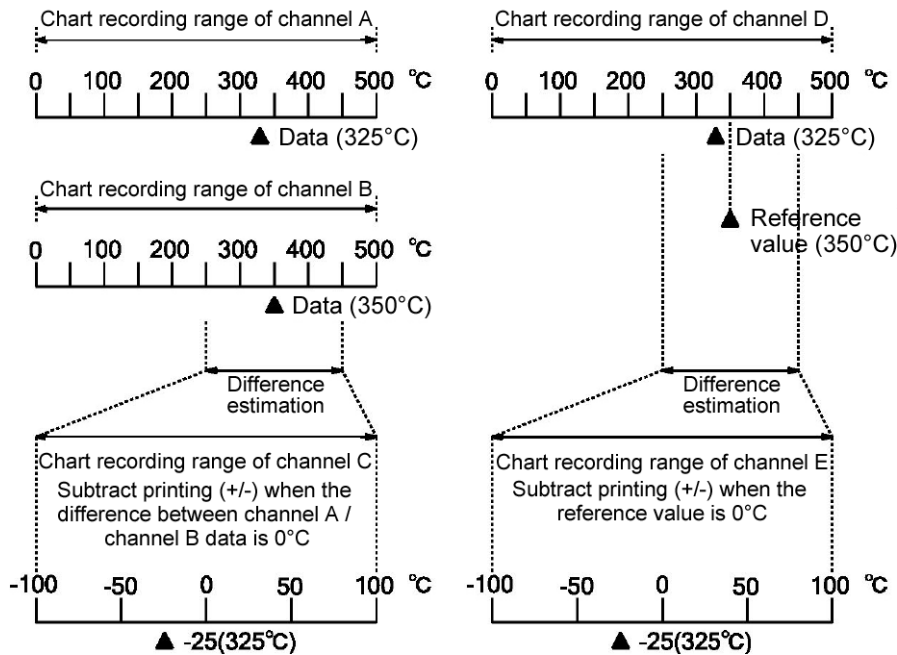

Note 1 Setting reference value

Set Const (reference value) within five digits. The decimal point position is linked to the scale setting which is set in input type settings.

Note 2 Specifying channel for subtract printing

You can select any channel for subtract printing. For example, CH02 can be specified to handle the result of CH01 - CH02. In this case, the display or record of CH02 (on a chart or SD card) will be “difference”.

Note 3 For the case DC voltage is selected for INPUT in input type settings

For a scale-set channel selecting DC voltage input, difference calculation is performed using the scaling value (actual scale value).

2. Parameter settings

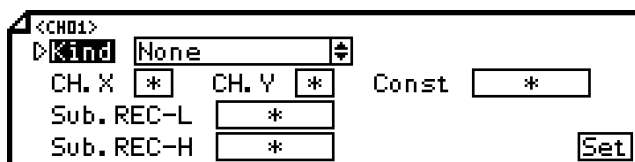
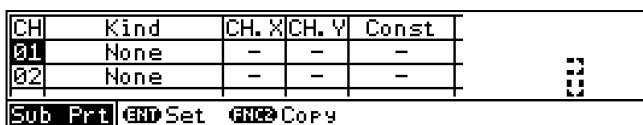
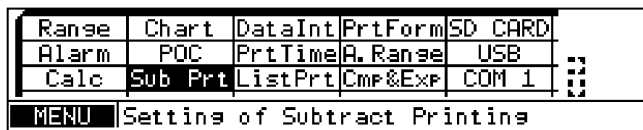

Note: Actual windows are separated. Use the ▲/▼ keys to scroll and continue settings.

- (1) Pressing the **MENU** key displays the menu window (list of setting items).
- (2) Select "Sub Prt".
- (3) Move the cursor to the target channel with the ▲/▼ keys and press the **ENTER** key. The cursor does not move to parameters other than CH.
 Also, pressing the **FUNC2** key on this window displays the copy window for subtract printing settings.
- (4) Move the cursor to the parameter to be set with the ▲/▼/◀/▶ keys.
- (5) Press the **ENTER** key to make it available for setting and then select or enter a value.
- (6) After completing the settings of this item, move the cursor to **Set**.
- (7) Press the **ENTER** key to register the settings (when chart recording is ON, a setting change mark is printed). To cancel the settings, press the **ESC** key.

[List of Sub Prt setting parameters]

Parameter	Function	Default	Set value
Kind		None	None, CH.X - CH.Y, CH.X - Const
CH.X	Set measuring CH as minuend	*	1 to 4
CH.Y	Set measuring CH as subtrahend	*	1 to 4
Const	Set reference value subtracted from CH.X	*	-30000 to 99999 Decimal point position is the same as CH.X scale setting
Sub.REC-L	Set lowest end of recording range for subtract printing	*	-30000 to 99999 Decimal point position is the same as CH.X scale setting
Sub.REC-H	Set highest end of recording range for subtract printing	*	-30000 to 99999 Decimal point position is the same as CH.X scale setting

8-10. Periodic (Data Interval) Data Printing Settings “DataInt”

In addition to the trace printing on a chart, measured data of each channel can be printed numerically. Measured data can be recorded or printed digitally at desired intervals. Select ON/OFF to enable or disable digital recording/printing for each channel (DIGI.REC) in input type settings described in “8-2. Input Type Settings”.



Range	Chart	DataInt	PrtForm	SD CARD
Alarm	POC	PrtTime	A. Range	USB
Calc	Sub Prt	ListPrt	Cmp&Exp	COM 1
MENU Settings of DataInterval				

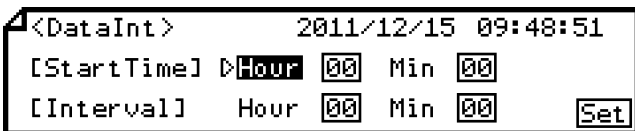

(1) Pressing the **MENU** key displays the menu window (list of setting items).

(2) Select “DataInt”.

(3) Move the cursor to the parameter to be set with the **▲/▼/◀/▶** keys.

(4) Press the **ENTER** key to make it available for setting and then enter a value.

(5) After completing the setting of this item, move the cursor to **Set**.

(6) Press the **ENTER** key to register the settings (when chart recording is ON, a setting change mark is printed). To cancel the settings, press the **ESC** key.

[List of DataInt setting parameters]

Parameter	Function	Default	Set value
StartTime	Set start time of periodic data printing (When a set time is before the current time, periodic data printing is executed next day.)	00 : 00	00 : 00 to 23 : 59
Interval	Set interval between printings of numeric measured data (every 24 hours 59 minutes and 1 minute at maximum)	00 : 00	00: 00 to 24 : 59

Reference **Calculating the shortest interval**

The shortest interval depends on the chart speed and the number of digital recording/printing channels. If a set interval is inappropriate for the specified chart speed, printing will be executed with a timing of the minimum integral multiple of the interval.

$$\text{Interval [M]} \geq \frac{180 \times \text{printing lines} *2}{\text{Chart speed [mm/H]} *1}$$

Note: Interval less than 5min cannot be set.

*1: The lowest speed of three speeds is used.

*2: Differs depending on the chart speed and the number of digital recording/printing channels.

Chart speed	1CH	2CH	3CH	4CH
99mm/H or less	1 row		2 row	
100mm/H or more	1 row	2 row	3 row	4 row

Note: This differs from the number of skipped channels.

8-11. Periodic (Specified Time) Data Printing Settings “PrtTime”

When the interval described in “8-11. Periodic (Data Interval) Data Printing Settings” is set to “00 : 00”, printing at specified time becomes effective. Time can be specified for up to 24 points and it can be set to ON/OFF individually.

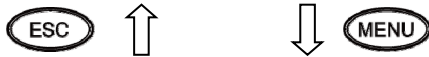

Range	Chart	DataInt	PrtForm	SD CARD
Alarm	POC	PrtTime	A.Range	USB
Calc	Sub Prt	ListPrt	Cmp&Exp	COM 1
MENU Settings of the print time				



PrintTime: OFF	No.	PrintTime	2011/12/15
	01	-	09:51:35
	02	-	
PrtTime Set ON/OFF COPY			



<No.01>	2011/12/15	09:52:29
[PrintTime] >Hour	-	Min *
Set		

(1) Pressing the **MENU** key displays the menu window (list of setting items).

(2) Select “PrtTime”.

(3) Move the cursor to the target No. with the **▲/▼** keys and press the **ENTER** key. The cursor does not move to parameters other than No.

Pressing the **FUNC1** key on this window turns ON/OFF printing at specified time.

Also, pressing the **FUNC2** key displays the copy window for specified time data printing settings.

(4) Move the cursor to the parameter to be set with the **▲/▼/◀/▶** keys.

(5) Press the **ENTER** key to make it available for setting and then enter a value.

(6) After completing the setting of this item, move the cursor to **Set**.

(7) Press the **ENTER** key to register the setting (when chart recording is ON, a setting change mark is printed). To cancel the setting, press the **ESC** key.

[PrtTime setting parameter]

Parameter	Function	Default	Set value
PrintTime	Set at what time measured data is printed numerically	-	- (Not used), 00 : 00 to 23 : 59

Reference ON/OFF setting for each print time No.

When [Print Time] is set to “-”, the setting of the relevant No. of specified time will be disabled.

8-12. List Printing Settings “ListPrt”

List printing is used to check the set contents. Contents to be printed depend on the list number.



Range	Chart	DataInt	PrtForm	SD CARD
Alarm	POC	PrtTime	A.Range	USB
Calc	Sub Prt	ListPrt	Cmp&Exp	COM 1
MENU Select printing list				

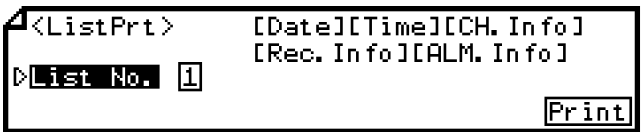

(1) Pressing the **MENU** key displays the menu window (list of setting items).

(2) Select “ListPrt”.

(3) Press the **ENTER** key to make it available for setting and then select the list number. Contents to be printed will be shown on the right.

(4) Move the cursor to **Print**.

(5) Pressing the **ENTER** key moves cartridge pen to the end of the left side and the chart paper forwards slightly then starts list printing. Press the **ESC** key to cancel.

Printed contents by List No.]

List No.	Printed contents
1	Date, Time, CH.Info (channel settings), Rec.Info (recording settings), ALM.Info (alarm settings)
2	Additional Setting, Option Setting Time
3	Date, Time, CH.Info (channel settings), Rec.Info (recording settings), ALM.Info (alarm settings), Additional Setting, Option Setting Time

Note 1 Inexecutable case

List printing is available only when recording is ON.

Note 3 Operation at printing in process

Trace printing by cartridge pen is not executed. Other operations are executed continuously without interruption. During list printing, setting change is not available. However, setting confirmation is available.

Note 2 Stopping list printing

To stop list printing, turn the recording status OFF and then ON again. List printing stops when the currently printing line is finished. When list printing is stopped, it cannot be resumed, so you need to set list printing again to perform it.

Example of list printing

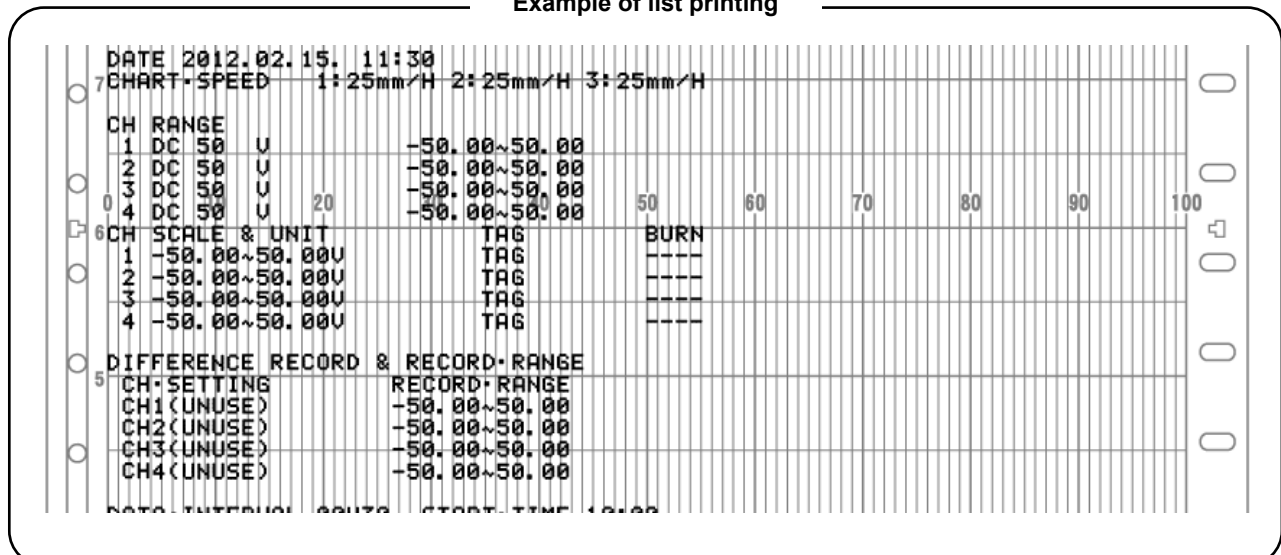

8-13. Message Printing 1 Settings “MsgPrt1”

A message consisting of 15 characters at maximum can be printed and up to 20 types of message can be registered. It is also possible to print a registered message in conjunction with the calendar timer or remote contacts (calendar timer and remote contacts should be set separately).



Calc	Sub Prt	ListPrt	Cmf&Exp	COM 1	↔
Formula	*	MsgPrt1	ZonePrt	COM 2	↔
Ses. Tbl	*	MsgPrt2	*	*	

MENU Settings of Message 1



No.	Message
01	
02	

MsgPrt1 ENT Set FUNC1 Print FUNC2 Copy



<No. 01>

▷Message

Set

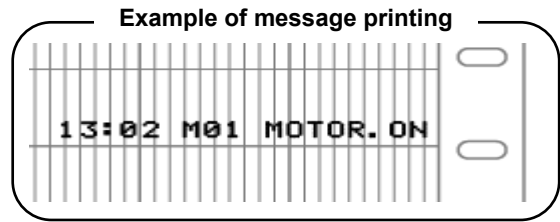

- (1) Pressing the **MENU** key displays the menu window (list of setting items).
- (2) Select “MsgPrt1”.
- (3) Move the cursor to the target message No. with the **▲/▼** keys and press the **ENTER** key. The cursor does not move to parameters other than No. Also, pressing the **FUNC1** key on this window prints the message of selected No. When “*** Start printing? ***” is displayed, press the **ENTER** key. Pressing the **FUNC2** key displays the copy window for message settings.
- (4) Move the cursor to the parameter to be set with the **▲/▼/◀/▶** keys.
- (5) Press the **ENTER** key to make it available for setting and then select or enter a value.
- (6) After completing the settings of this item, move the cursor to **Set**.
- (7) Press the **ENTER** key to register the settings (when chart recording is ON, a setting change mark is printed). To cancel the settings, press the **ESC** key.

[List of MsgPrt1 setting parameters]

Parameter	Function	Default	Set value
Message	Set a string consisting of up to 15 characters to be printed	Not set	

8-14. Message Printing 2 Settings “MsgPrt2”

A message consisting of up to 72 characters is printed on a chart with arbitrary timing. Message is registered at the time of printing and the last registered message is shown on the setting window.



Calc	Sub Prt	ListPrt	Cmp&Exp	COM 1	F7
Formula	*	MsaPrt1	ZonePrt	COM 2	F8
Seq. Tbl	*	MsaPrt2	*	*	

MENU Setting of Message 2

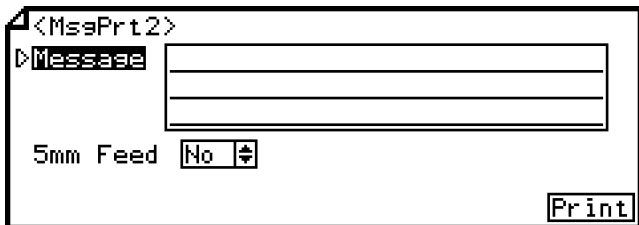

Note: Actual windows are separated. Use the ▲/▼ keys to scroll and continue settings.

(1) Pressing the **MENU** key displays the menu window (list of setting items).

(2) Select “MsgPrt2”.

(3) Move the cursor to the parameter to be set with the ▲/▼/◀/▶ keys.

(4) Press the **ENTER** key to make it available for setting and then select or enter a value.

(5) After completing the settings of this item, move the cursor to **Print**.

(6) Pressing the **ENTER** key displays the message “*** Start printing? ***”. Press the **ENTER** key again to start message printing. Press the **ESC** key to cancel printing.

[List of MsgPrt2 setting parameters]

Parameter	Function	Default	Set value
Message	Set a string consisting of up to 72 characters to be printed	Not set	
5mm Feed	No: Prints message in synchronization with chart speed while executing trace printing Yes: Interrupts trace printing and prints message regardless of chart speed	No	No (no feed), Yes (feed)

8-15. Recording Format Settings “PrtForm”

Set the format for trace printing depending on the intended use.

This function is provided to select the format used for trace printing. Input range and its accuracy are determined by the settings made in “8-2. Input Type Settings”.

The recording format cannot be set for each individual channel. Select one from the following options which is shared by all channels. However, when selecting the automatic range-shift or compressed/expanded printing, whether or not to use the function can be specified for each channel. A channel specified not to use the function will use the standard format.

- Automatic range-shift Recording range is shifted automatically depending on the input range.
- Compressed/expanded printing Chart recording area can be partially shrunk or expanded.
- Zone printing Chart recording area can be divided into four areas at maximum.



- (1) Pressing the **MENU** key displays the menu window (list of setting items).

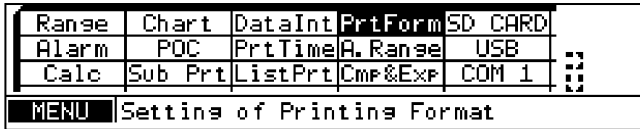

- (2) Select “PrtForm”.



- (3) Press the **ENTER** key to make it available for setting and then select a value.
- (4) After completing the setting of this item, move the cursor to **Set**.
- (5) Press the **ENTER** key to register the setting (when chart recording is ON, a setting change mark is printed). To cancel the setting, press the **ESC** key.

[PrtForm setting parameter]

Parameter	Function	Default	Set value
Printing Format	Select recording format	Standard	Standard, Auto Range Normal (automatic range-shift normal), Auto Range Overlap (automatic range-shift overlap), Comp.&Exp.Print (compressed/expanded printing), Zone Print (parallel scale)

8-16. Auto Range Settings “A.Range”

When “Auto Range” is selected for recording format, set the related items. There are two types of automatic range-shift: “Normal” and “Overlap”, the former has separate ranges and the latter has ranges overlapping each other partially around the lower/upper limit. Chart recording range is switched between five ranges at maximum for “Normal” or three ranges at maximum for “Overlap” depending on the measured value. To switch from “Normal” to “Overlap” or vice versa, you need to reset the related items.

- Individual setting available for channels.
- Recording range can be set arbitrarily regardless of the setting of range/chart recording upper and lower limits.
- When a measured value is near a range-shift point, chattering of recording at 0% or 100% position may occur. To prevent this, a range-shift is performed at the point where a measured value exceeds the lower (zero) or higher (span) limit of each range by 0.5mm.
- You can use a copy function for the setting. However, note that the decimal point position depends on the value at destination even if the source value has different decimal point position.

Example: Source value “120.3”, value at destination “20.05” → value after copy “12.03”

Example of Auto Range settings (Normal)

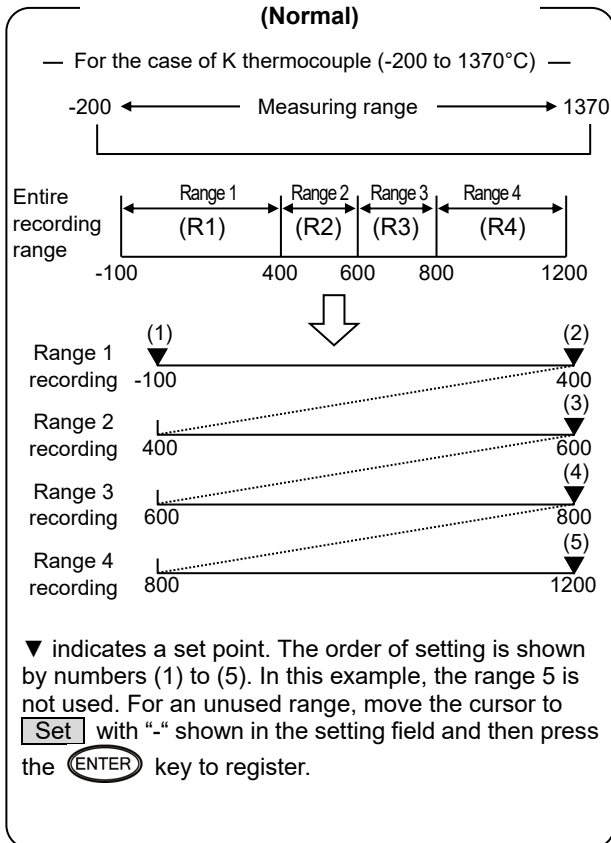

Example of Auto Range settings (Overlap)

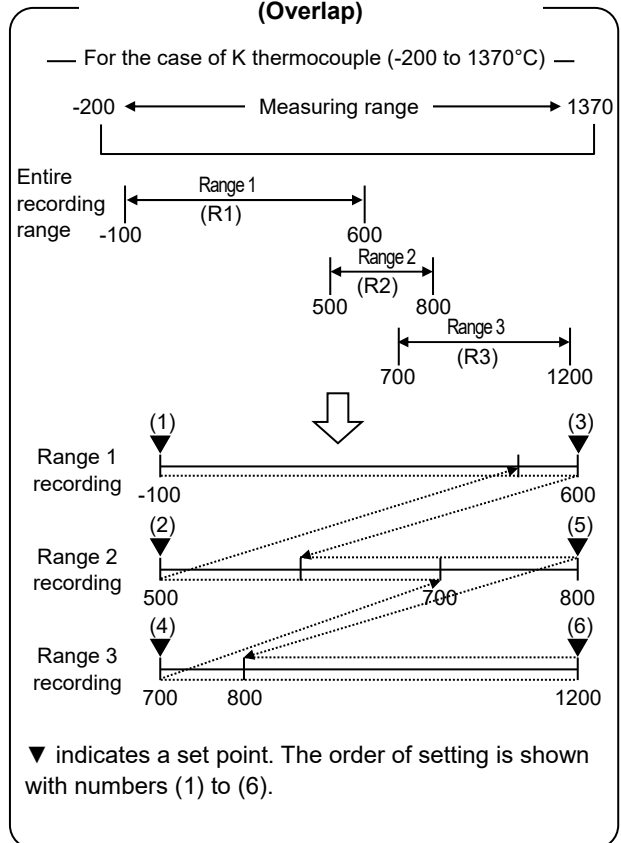

* Make sure that the recording format is set to “Auto Range (automatic range-shift)” and then perform the following settings.

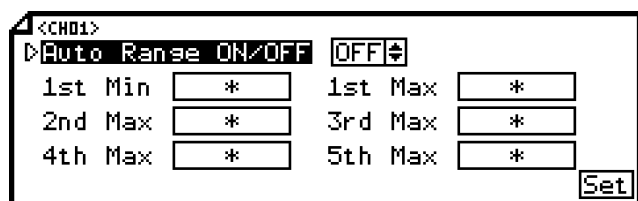
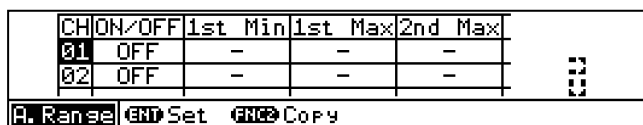
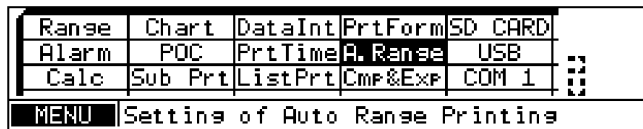

Note: Actual windows are separated. Use the ▲/▼ keys to scroll and continue settings.

(1) Pressing the **MENU** key displays the menu window (list of setting items).

(2) Select “A.Range”.

(3) Move the cursor to the target channel with the ▲/▼ keys and press the **ENTER** key. The cursor does not move to parameters other than CH.

Also, pressing the **FUNC2** key on this window displays the copy window for Auto Range settings.

(4) Press the **ENTER** key while the cursor is on “Auto Range ON/OFF” and select ON.

(5) Move the cursor to the parameter to be set with the ▲/▼/◀/▶ keys.

(6) Press the **ENTER** key to make it available for setting and then select or enter a value. If the set value of 1st Max is equal to or less than 1st Min value, it will not be accepted. The set value should be: 1st Min < 1st Max < 2nd Max < 3rd Max ...

(7) After completing the settings of this item, move the cursor to **Set**.

(8) Press the **ENTER** key to register the settings (when chart recording is ON, a setting change mark is printed). To cancel the settings, press the **ESC** key.

[List of A.Range setting parameters] Upper section: Auto Range (Normal), Lower section: Auto Range (Overlap)

Parameter	Function	Default	Set value
Auto Range ON/OFF		OFF	ON (enabled), OFF (disabled)
1st Min	Set lowest end of 1st range	*	- (None), -30000 to 99999
1st Min	Set lowest end of 1st range	*	Decimal point position is the same as CH scale setting
1st Max	Set highest end of 1st range	*	- (None), -30000 to 99999
2nd Min	Set lowest end of 2nd range	*	Decimal point position is the same as CH scale setting
2nd Max	Set highest end of 2nd range	*	- (None), -30000 to 99999
1st Max	Set highest end of 1st range	*	Decimal point position is the same as CH scale setting
3rd Max	Set highest end of 3rd range	*	- (None), -30000 to 99999
3rdMin	Set lowest end of 3rd range	*	Decimal point position is the same as CH scale setting
4th Max	Set highest end of 4th range	*	- (None), -30000 to 99999
2nd Max	Set highest end of 2nd range	*	Decimal point position is the same as CH scale setting
5th Max	Set highest end of 5th range	*	- (None), -30000 to 99999
3rd Max	Set highest end of 3rd range	*	Decimal point position is the same as CH scale setting

8-17. Compressed/Expanded Printing Settings “Cmp&Exp”

When “Comp. &Exp.Print” is selected for recording format, set the related items. A specified area within the chart recording range can be shrunk or expanded.

- Individual setting available for channels.
- Recording range can be set arbitrarily regardless of the setting of range/chart recording upper and lower limits.
- Up to two break points can be set, therefore three shrunk or expanded areas can be obtained at maximum.

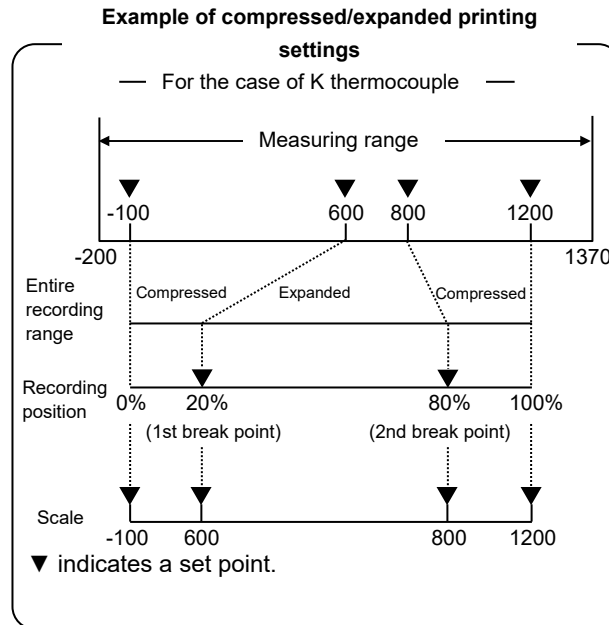

* Make sure that the recording format is set to “Comp.&Exp.Print (compressed/expanded printing)” and then perform the following settings.

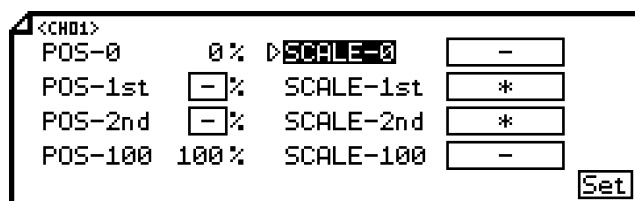
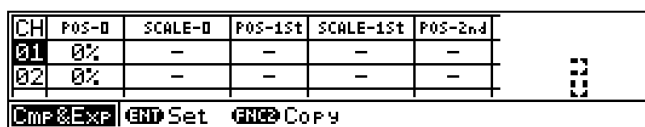

Note: Actual windows are separated. Use the ▲/▼ keys to scroll and continue settings.

(1) Pressing the **MENU** key displays the menu window (list of setting items).

(2) Select “Comp&Exp”.

(3) Move the cursor to the target channel with the ▲/▼ keys and press the **ENTER** key. The cursor does not move to parameters other than CH.

Also, pressing the **FUNC2** key on this window displays the copy window for compressed/expanded printing settings.

(4) Move the cursor to the parameter to be set with the ▲/▼/◀/▶ keys.

(5) Press the **ENTER** key to make it available for setting and then enter a value.

Set POS (recording position) to 0 to 100% for a 0-180mm chart, satisfying the following condition: POS-1st < POS-2nd. Also, set SCALE (recording range) to a scale value at the specified position with attention to the decimal point position.

(6) After completing the settings of this item, move the cursor to **Set**.

(7) Press the **ENTER** key to register the settings (when chart recording is ON, a setting change mark is printed). To cancel the settings, press the **ESC** key.

[List of Cmp&Exp setting parameters]

Parameter	Function	Default	Set value
SCALE-0	Set recording scale at 0% recording position	*	- (None), -30000 to 99999 Decimal point position is the same as specified CH scale
POS-1st	Set percentage of recording position of 1st break point to span	-	- (Not used), 1 to 99
SCALE-1st	Set recording scale of 1st break point	*	-30000 to 99999 Decimal point position is the same as specified CH scale
POS-2nd	Set percentage of recording position of 2nd break point to span	-	- (Not used), 1 to 99
SCALE-2nd	Set recording scale of 2nd break point	*	-30000 to 99999 Decimal point position is the same as specified CH scale
SCALE-100	Set recording scale at 100% recording position	*	- (None), -30000 to 99999 Decimal point position is the same as specified CH scale

8-18. Zone Printing Settings “ZonePrt”

When “Zone Print” is selected for recording format, set the number of divisions and recording area. Recording area can be divided into two to four, and you can select an area for recording. This is useful to avoid overlapping of recordings.

- CH or CH range is specified for each recording area.
- The recording range in each area uses the range specified by range/chart recording upper and lower limits.
- See the following table for recording positions [mm] which vary by the number of divisions.

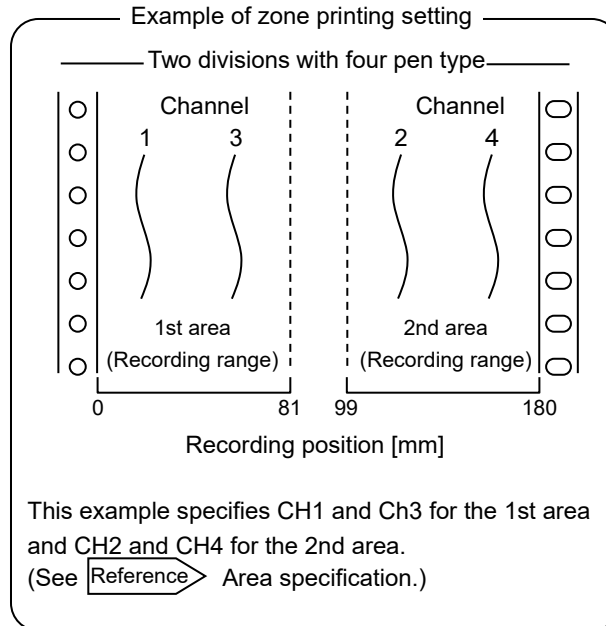

Division	1st area	2nd area	3rd area	4th area
2	0 to 81	99 to 180		
3	0 to 54	63 to 117	126 to 180	
4	0 to 36	45 to 81	99 to 135	144 to 180

* Make sure that the recording format is set to "Zone Print (zone printing)" and then perform the following settings.



Alarm	POC	PrtTime	A. Range	USB	↕
Calc	Sub Prt	ListPrt	Cmp&Exp	COM 1	↕
Formula	*	MsaPrt1	ZonePrt	COM 2	↕

MENU Settings of Parallel Recording



	Area1	Area2	Area3	Area4
CH	-	-	-	-

ZonePrt [Set]



```

<ZonePrt>
  >Zone 2
    [Area1]
      Type (CH.X)
      CH.X - CH.Y * CH.Z *
    [Area2]
      Type (CH.X)
      CH.X - CH.Y * CH.Z *
  [Set]
  
```

Note: Actual windows are separated. Use the ▲/▼ keys to scroll and continue settings.
 The number of areas increases as you select a greater number for division (Zone), resulting in the need of setting more parameters.

- (1) Pressing the **MENU** key displays the menu window (list of setting items).
- (2) Select "ZonePrt".
- (3) Press the **ENTER** key.
- (4) Move the cursor to the parameter to be set with the ▲/▼/◀/▶ keys.
- (5) Press the **ENTER** key to make it available for setting and then select or enter a value.
- (6) After completing the settings of this item, move the cursor to **Set**.
- (7) Press the **ENTER** key to register the settings (when chart recording is ON, a setting change mark is printed). To cancel the settings, press the **ESC** key.

[List of Zoneprt setting parameters]

Parameter	Function	Default	Set value
Zone	Set number of divisions for zone printing	2	2 to 4
Type	Area specification format Selected from options	CH.X	CH.X, CH.X/CH.Y, CH.X - CH.Y, CH.X/CH.Y/CH.Z, CH.X - CH.Y/CH.Z, CH.X/CH.Y - CH.Z
CH.X		-	- (Not used), 1 to 4
CH.Y		*	- (Not used), 1 to 4
CH.Z		*	- (Not used), 1 to 4

Reference Area specification (Type)

- (CH.X)Record CH.X to the specified area.
- (CH.X)/(CH.Y)Record CH.X and CH.Y to the specified area.
- (CH.X) - (CH.Y)Record CH.X - CH.Y to the specified area.
- (CH.X)/(CH.Y)/(CH.Z)Record CH.X, CH.Y and CH.Z to the specified area.
- (CH.X) - (CH.Y)/(CH.Z)Record CH.X - CH.Y and CH.Z to the specified area.
- (CH.X)/(CH.Y) - (CH.Z)Record CH.X and CH.Y - CH.Z to the specified area.

Note CH selection

A channel not selected for any area will be skipped.
 An error occurs when the same channel is set for multiple areas.

8-19. SD Card “SD CARD”

Measured data can be stored on an SD card at arbitrarily specified time and interval (0.1sec at maximum). Also, measurement/recording conditions including range, scale and chart speed can be stored on an SD card, and the stored data can be used to set up the instrument when needed.

SD card is an accessory part (sold separately). Use one provided by Azbil.

If using SD card other than the one provided by Azbil (sold separately), data may be damaged and lost.

1. Attaching/removing SD card

Insert an SD card with the label facing down into the insertion slot located at the front section of internal unit. When an SD card is inserted, the “CARD” status LED in the operation/set keys section flashes in green, and an error check is performed automatically. When the card is successfully recognized, the status LED stops flashing and stays on.

To remove an SD card, you must take the steps for proper removal.

(See “8-19.7. Removing SD card”.)

SD card can be removed from the slot by pressing it inward and releasing it with you finger.

2. Operation

There are three types of SD card operation menu: Recording data-Saving (settings related to measured data save), Setting Parameter (saving/loading setting parameters) and SD Card (removal/maintenance).

When a recording to SD card starts, the status on the display turns from “SD” to “R”.

3. Handling

Observe the following warnings and cautions to use SD card safely and prevent loss or damage to your property.

 Warning	<ul style="list-style-type: none">● Never disassemble or modify SD card. It may result in fire, electric shock or malfunction.● Do not use SD card in a location where it may get wet or condensation occurs. The internal circuit of SD card may be damaged in such a location.● Do not handle (attach/remove) SD card near small children to avoid accidental ingestion or other dangerous situations.
--	--

 Caution	<ul style="list-style-type: none">● Do not store SD card in a location exposed to direct sunlight, high temperature, high humidity or too much dust. It may degrade the quality by distortion or warping.● Do not apply strong impact by dropping, hitting or bending it. It may distort and damage SD card.● Store SD card with care not to allow dust to enter the connector.● To protect the internal circuit from static electricity, do not touch the connector (terminal) with your hand or a metal object.
--	--

Note About SD card

- Do not remove SD card or turn off the power while the “CARD” status LED is lit.
- SD card has been formatted to FAT prior to shipment (SD card is an optional device).
- Execution of format deletes all the stored data. Check the data before starting format.
- While SD card is being accessed, never remove the SD card or turn off the unit connecting the SD card. Otherwise, the data of SD card may be destroyed or the unit itself may be damaged.
- Please note that Azbil holds no responsibilities for losses resulting from damage or data loss of SD card.
- Use SD card with 2GB or less memory and format to FAT16. Use Azbil's SD card sold separately. If using SD card other than the one provided by Azbil (sold separately), data may be damaged and lost.

4. Settings related to measured data save

Set the format for recording measured data on SD card, trigger to start/stop recording and measuring interval.

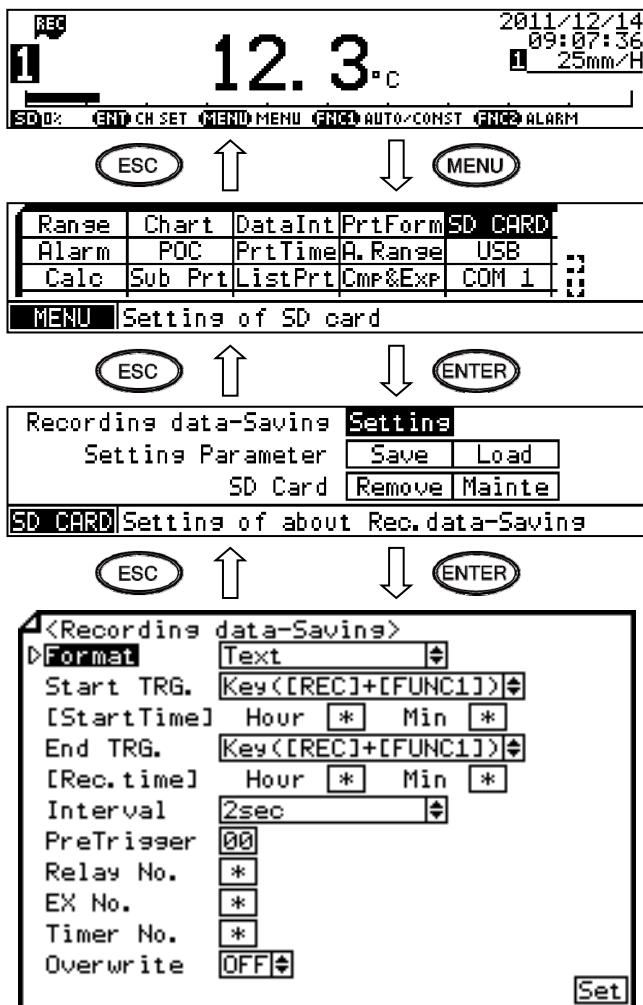

- (1) Pressing the **MENU** key displays the menu window (list of setting items).
- (2) Select "SD CARD".
- (3) Make sure that the cursor is on **Setting** beside "Recording data-Saving" and then press the **ENTER** key.
- (4) Move the cursor to the parameter to be set with the **▲/▼/◀/▶** keys.
- (5) Press the **ENTER** key to make it available for setting and then select or enter a value.
- (6) After completing the settings of this item, move the cursor to **Set**.
- (7) Press the **ENTER** key to register the settings (when chart recording is ON, a setting change mark is printed). To cancel the settings, press the **ESC** key.

Note: Actual windows are separated. Use the **▲/▼** keys to scroll and continue settings.

Note 1 Relation between start time and start trigger

If a specified start time is before the current time, recording will start from the next day.

Note 2 Loading parameter during recording

When you load setting parameters while measured data is being recorded, the recording process will be stopped.

Note 3 Key operation for handling start trigger

To operate the start trigger with keys, set the start trigger to other than "None". Even when the start trigger is set to other than "Key", a start by key operation is given higher priority than other methods. The same can be applied to the end trigger. Both start and end triggers can be executed on any window. The confirmation message: "**** Start recording to SD-Card? ****" or "**** Quit recording to SD-Card? ****" will be displayed by pressing the **REC** key → **FUNC1** key. Press the **ENTER** key to execute or the **ESC** key to cancel.

[List of Recording data-Saving setting parameters]

Parameter	Function	Default	Set value
Format	Select format for recording to SD card	Text	Binary: Uses "A4F" extension. Analysis software is required for data replay. Text: Uses "TXT" extension. Data can be replayed with Microsoft Excel as needed. Binary (float): Binary (floating decimal point) Text (float): Text (floating decimal point)
Start TRG.	Select trigger for recording start	Key	None (None), Key (started by REC + FUNC1 key), StartTime (specified time), Alarm (linked to alarm output), EX (linked to remote contact), Chart (linked to chart recording), Chart End (linked to chart end), Timer (linked to calendar timer)
[StartTime]	Set recording start time when selecting "StartTime" for Start TRG	*	00 : 00 to 23 : 59
End TRG.	Select trigger for recording stop	Key	Key (stopped by REC + FUNC1 key), Rec.time (specified time), Alarm (linked to alarm output), EX (linked to remote contact), Chart (linked to chart recording), Chart End (linked to chart end), Timer (linked to calendar timer)
[Rec.time]	Set recording time when selecting "Rec.time" for End TRG	*	00 : 00 to 99 : 59
Interval	Select interval of recording to SD card	1sec	0.1sec, 0.2sec, 0.5sec, 1sec, 2sec, 3sec, 5sec, 10sec, 15sec, 20sec, 30sec, 1min, 2min, 3min, 5min, 10min, 15min, 20min, 30min, 60min
PreTrigger	Past data for the specified number of samples is recorded to SD card when recording is started *When the recording interval is less than 1 second, the number of samples is fixed to 10 (except for setting 0).	00	0 to 10 Note: Past data is initialized when settings are changed or card is inserted/removed. When PreTrigger is set, the recording interval synchronizes with past data, so there may be a case that measured data at recording start time is not recorded.
Relay No.	Set alarm output No. used when "Alarm" is selected for Start TRG or End TRG	*	- (No output), 99 (internal circuit output), 1 to 12
EX No.	Set remote contact No. used when "EX" is selected for Start TRG or End TRG	*	- (None), 1 to 10
Timer No.	Set remote contact No. used when "Timer" is selected for Start TRG or End TRG	*	- (None), 1 to 5
Overwrite	Select overwrite mode	OFF	ON, OFF

[Restrictions on start/end trigger selection]

		End trigger						
		Key	Specified time	Alarm output linked	Remote contact linked	Chart recording linked	Chart end linked	Calendar timer linked
Start trigger	None	x	x	x	x	x	x	x
	Key	O	O	x	x	x	x	x
	Specified time	O	O	x	x	x	x	x
	Alarm output linked	O	O	O	x	x	x	x
	Remote contact linked	O	O	x	O	x	x	x
	Chart recording linked	x	O	x	x	O	x	x
	Chart end linked	O	O	x	x	x	O	x
	Calendar timer linked	O	O	x	x	x	x	O

Note Overwrite mode of measured data

When overwrite mode is ON and the free space on SD card decreases to 1 % or lower, the oldest measured data is deleted.
When overwrite mode is OFF and the free space on SD card decreases to 1% or lower, the data may not be saved.

Note **File division**

Measured data file is divided by a certain number of bytes.
(The number of bytes varies by the number of recording channels, etc.)
Also, the file is divided if device setting or date and time setting is changed.

Reference **File save location**

A measured data file is saved in a folder created each year/month within the "HR_DATA" folder (for example, a folder is named "HR201101" for Jan. 2011).
Also, a setting parameter file is saved in the "HR_SET" folder.

5. Saving setting parameters

The setting data of the unit can be saved to an SD card.

Range	Chart	DataInt	PrtForm	SD CARD
Alarm	POC	PrtTime	A.Range	USB
Calc	Sub Prt	ListPrt	Cmp&Exp	COM 1
MENU Setting of SD card				



Recording data-Saving	Setting
Setting Parameter	Save Load
SD Card	Remove Mainte
SD CARD Save of Settings-data	



<Save>		FUNC1 DELETE	ENT SELECT
FileName	Update		
New	-	-	
01			



<New File>	2011/12/19 11:23:40
FileName	-
	Set

- (1) Select "SD CARD" from the menu window (list of setting items).

- (2) Move the cursor to **Save** beside "Setting Parameter" and press the **ENTER** key.

- (3) Select **New** to add a file. To overwrite a file, select the file No. to be overwritten. Also, pressing the **FUNC1** key on this window can remove the data of specified file No. from SD card. When "**** Delete? ****" is displayed, press the **FUNC1** key again to remove the data.

- (4) Press the **ENTER** key to make it available for setting and then enter a file name. Enter single-byte, upper-case alphanumeric characters up to eight digits.
- (5) After completing the settings of this item, move the cursor to **Set**.
- (6) Press the **ENTER** key. When "**** Start Saving? ****" is displayed, press the **FUNC1** key to start saving setting parameters to SD card. To cancel saving, press the **ESC** key.

Note 1 Setting file name

You cannot specify the same name for files even if they have different numbers.

Note 2 Number of files saved

The maximum number of setting parameter files which can be saved to a single SD card is 10.

Reference 1 File display order

On the setting file list window, files are displayed in the chronological order with the most recent updated file listed first.

Reference 2 Update date display

When a file name is registered on the setting parameter registration window, the update date will be reflected automatically.

6. Loading setting parameters

The setting data saved to an SD card can be loaded and set into the unit.

Range	Chart	DataInt	PrtForm	SD CARD
Alarm	POC	PrtTime	A.Range	USB
Calc	Sub Prt	ListPrt	Cmp&Exp	COM 1
MENU Setting of SD card				



Recording data-Saving	Settings
Setting Parameter	Save Load
SD Card	Remove Mainte
SD CARD Load of Settings-data	



<Load>		ENT SELECT
	FileName	UpDate
01		
02		

(1) Select "SD CARD" from the menu window (list of setting items).

(2) Move the cursor to **Load** of "Setting Parameter" and press the **ENTER** key.

(3) Move the cursor to the file No. to be loaded with the **▲/▼** keys and then press the **ENTER** key.

(4) Press the **ENTER** key. When "**** Start Loading? ****" is displayed, press the **FUNC1** key to start loading setting data. To cancel loading, press the **ESC** key.

Note 1 Save current settings

When you load setting parameters, all the current parameters will be overwritten. Save the current parameters to SD card before loading saved parameters.

Note 2 Loading cannot stop

It is not possible to stop loading saved parameters in the middle of the process.

7. Removing SD card

Make sure to take the following procedure to remove SD card.

Range	Chart	DataInt	PrtForm	SD CARD
Alarm	POC	PrtTime	A.Range	USB
Calc	Sub Prt	ListPrt	Cmp&Exp	COM 1
MENU Setting of SD card				



Recording data-Saving	Settings
Setting Parameter	Save Load
SD Card	Remove Mainte
SD CARD Remove of SD-Card	

(1) Select "SD CARD" from the menu window (list of setting items).

(2) Move the cursor to **Remove** beside "SD Card" and press the **ENTER** key.

(3) When "**** Stop the SD-Card? ****" is displayed, press the **FUNC1** key. Press the **ESC** key to cancel.

(4) Make sure that the green "CARD" status LED in the operation/set keys section turns off, and then remove SD card.

Note 3 Removing SD card during recording

You cannot remove SD card while recording to it. Error occurs when it is attempted.

8. SD card maintenance

Format SD card or delete old setting files according to the following procedure.

Range	Chart	DataInt	PrtForm	SD CARD	
Alarm	POC	PrtTime	A.Range	USB	⋮
Calc	Sub Prt	ListPrt	Cmp&Exp	COM 1	⋮
MENU					Setting of SD card



Recording data-Saving	Setting
Setting Parameter	Save Load
SD Card	Remove Mainte
SD CARD	Maintenance of SD-Card

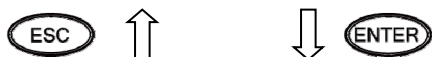

<Mainte>	FUNC2 FORMAT	END DELETE
FileName	UpDate	

(1) Select "SD CARD" from the menu window (list of setting items).

(2) Move the cursor to **Mainte** of "SD Card" and press the **ENTER** key.

(3) Perform desired maintenance.
 Press the **FUNC2** key to format SD card. When "Format the SD-Card?" is displayed, press the **FUNC1** key to start formatting.
 Selecting a file No. and pressing the **ENTER** key can remove the selected file from SD card. When "Delete?" is displayed, press the **FUNC1** key to delete the file.

Reference File display order

On the setting file list window, files are displayed in the chronological order with a file having the oldest update date listed first.

Note 1 Periodic maintenance

To use SD card at its maximum performance, format it periodically.

Note 2 Format

- Note that all the data saved on an SD card is deleted by formatting.
- You cannot format an SD card while recording.

8-20. USB Engineering Port Settings “USB”

Using the provided programming software, parameters can be set or changed on a personal computer. This port is connected to PC temporarily to set or change parameters and is not intended for long time connection. Refer to the instruction manual of provided programming software for details.

Type	Contents
USB connection mode [Mode]	Fixed to BULK Dedicated protocol is used.
USB identification [USB ID]	This is used to identify each unit when connecting multiple units (up to five units) to a PC.

* Set USB ID to “1” when using the provided programming software.
Only one unit can be connected to a PC.



(1) Pressing the **MENU** key displays the menu window (list of setting items).

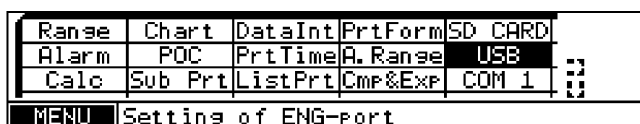

(2) Select “USB”.

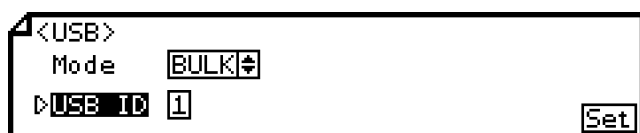

(3) Press the **ENTER** key to make it available for setting and then enter a value.
 (4) After completing the settings of this item, move the cursor to **Set**.
 (5) Press the **ENTER** key to register the settings (when chart recording is ON, a setting change mark is printed). To cancel the settings, press the **ESC** key.

[List of USB setting parameters]

Parameter	Function	Default	Set value
Mode	Connection mode	BULK	Fixed to BULK
USB ID	USB identification	1	1 to 5

8-21. Calendar Timer Settings “Timer”

Alarm relay output ON/OFF or message printing can be executed on a date specified arbitrarily. Up to five dates can be set, and alarm relay output ON/OFF or message No. can be specified for each date.

Actual printing is executed in the following order: “Date”, “Time”, “Timer No.” and then “Message”.

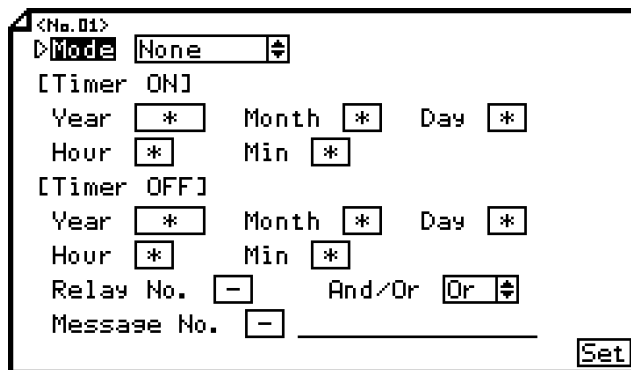
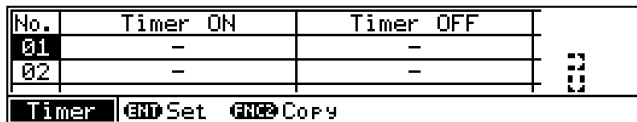

Note: Actual windows are separated. Use the ▲/▼ keys to scroll and continue settings.

(1) Pressing the **MENU** key displays the menu window (list of setting items).

(2) Select “Timer”.

(3) Move the cursor to the target calendar timer No. with the ▲/▼ keys and press the **ENTER** key. The cursor does not move to parameters other than No.

Also, pressing the **FUNC2** key on this window displays the copy window for calendar timer settings.

(4) Move the cursor to the parameter to be set with the ▲/▼/◀/▶ keys.

(5) Press the **ENTER** key to make it available for setting and then select or enter a value.

(6) After completing the settings of this item, move the cursor to **Set**.

(7) Press the **ENTER** key to register the settings (when chart recording is ON, a setting change mark is printed). To cancel the settings, press the **ESC** key.

[List of Timer setting parameters]

Parameter	Function	Default	Set value
Mode	Select timer type	None	None, ON (specify ON time only) ON & OFF (specify both ON and OFF times)
[Timer ON]	Set date and time for alarm output ON or message printing	*	Jan 1, 2000 to Dec 31, 2099 00 : 00 to 23 : 59
[Timer OFF]	Set date and time for alarm output OFF	*	Jan 1, 2000 to Dec 31, 2099 00 : 00 to 23 : 59
Relay No.	Specify relay No. for timer ON output	*	- (No output at timer ON), 99 (internal circuit output), 1 to 12
And/Or	Select circuit type for timer ON output	*	And, Or
Message No.	Specify message No. printed at timer ON	*	- (Message not printed at timer ON), 1 to 20

8-22. Fail Output Settings “FailOut”

Set the alarm operation performed at an activation of system related alarm (chart end, disconnection of input, SD card error or low capacity, low backup battery level or other system error).

The SD card low-capacity alarm is activated when the free space on SD card decreases to 3% or lower.

The backup battery low-level alarm is activated when the voltage of backup battery for clock drops to 2.0V or lower.

The status information of other errors can be viewed by selecting “SysInfo” from the menu window.

Each alarm is turned off when the alarm condition is cleared or alarm operation is disabled in this setting (individual setting available).



A. Range	USB	SNTP	Dis. Inp.	D. Order	
Cmp&Exp	COM 1	E-mail	Ops. Rec	Date	
ZonePrt	COM 2	*	FailOut	System	
MENU Settings of output destination of the					

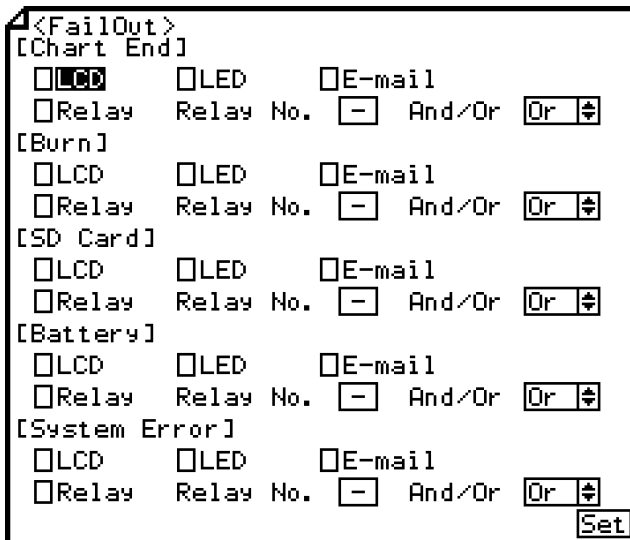

(1) Pressing the **MENU** key displays the menu window (list of setting items).

(2) Select “FailOut”.

(3) Move the cursor to the parameter to be set with the **▲/▼/◀/▶** keys.

(4) Press the **ENTER** key and check the check box of required items. Also, set the desired relay No. for output and circuit type.

(5) After completing the settings of this item, move the cursor to **Set**.

(6) Press the **ENTER** key to register the settings (when chart recording is ON, a setting change mark is printed). To cancel the settings, press the **ESC** key.

Note: Actual windows are separated. Use the **▲/▼** keys to scroll and continue settings.

[List of FailOut setting parameters]

Parameter	Function	Default	Set value
Chart End	Set alarm operation at detection of chart end	Not selected	LCD (LCD display), LED (LED indication), E-mail, Relay (relay output) Check a check box of desired item.
Chart End Relay No.	Set alarm output relay No. at detection of chart end	-	- (No output), 99 (internal circuit output), 1 to 12
Chart End And/Or	Select circuit type of alarm output at detection of chart end	Or	And, Or
Burn	Set alarm operation at detection of input disconnection	Not selected	LCD (LCD display), LED (LED indication), E-mail, Relay (relay output) Check a check box of desired item.
Burn Relay No.	Set alarm output relay No. at detection of input disconnection	-	- (No output), 99 (internal circuit output), 1 to 12
Burn And/Or	Select circuit type of alarm output at detection of input disconnection	Or	And, Or
SD Card	Set alarm operation at detection of SD card low capacity	Not selected	LCD (LCD display), LED (LED indication), E-mail, Relay (relay output) Check a check box of desired item.
SD Card Relay No.	Set alarm output relay No. at detection of SD card low capacity	-	- (No output), 99 (internal circuit output), 1 to 12
SD Card And/Or	Select circuit type of alarm output at detection of SD card low capacity	Or	And, Or
Battery	Set alarm operation at detection of backup battery low level	Not selected	LCD (LCD display), LED (LED indication), E-mail, Relay (relay output) Check a check box of desired item.
Battery Relay No.	Set alarm output relay No. at detection of backup battery low level	-	- (No output), 99 (internal circuit output), 1 to 12
Battery And/Or	Select circuit type of alarm output at detection of backup battery low level	Or	And, Or
System Error	Set alarm operation at detection of system error	Not selected	LCD (LCD display), LED (LED indication), E-mail, Relay (relay output) Check a check box of desired item.
System Error Relay No.	Set alarm output relay No. at detection of system error	-	- (No output), 99 (internal circuit output), 1 to 12
System Error And/Or	Select circuit type of alarm output at detection of system error	Or	And, Or

8-23. Display Settings “Display”

The display mode, channel update interval, brightness and chart illumination can be set. When the display backlight and chart illumination are set to “AUTO” in ON/OFF/AUTO setting, the LCD backlight and chart illumination will be turned off when an unused period reaches three minutes. They will be turned on when any key is pressed.

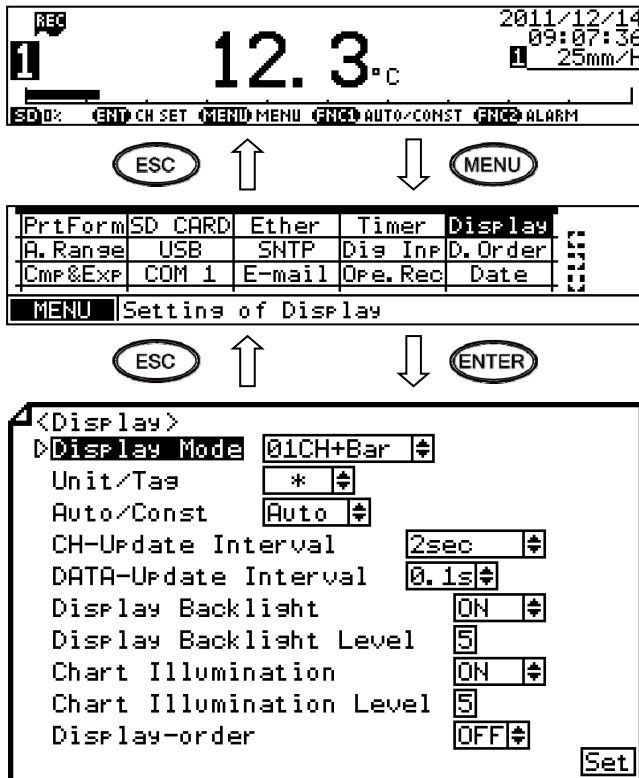

(1) Pressing the **MENU** key displays the menu window (list of setting items).

(2) Select “Display”.

(3) Move the cursor to the parameter to be set with the **▲/▼/◀/▶** keys.

(4) Press the **ENTER** key to make it available for setting and then select or enter a value.

(5) After completing the settings of this item, move the cursor to **Set**.

(6) Press the **ENTER** key to register the settings (when chart recording is ON, a setting change mark is printed). To cancel the settings, press the **ESC** key.

Note: Actual windows are separated. Use the **▲/▼** keys to scroll and continue settings.

Note Do not look at light directly

Do not look at the chart illumination directly for the risk of serious eye damage.

[List of Display setting parameters]

Parameter	Function	Default	Set value
Display Mode	Select number of channels and information displayed on a single window	01CH+Bar	01CH, 01CH+Bar, 02CH, 02CH+Bar, 04CH (03CH), 04CH (03CH)+Bar, Indicator, Selectable display modes depend on the number of inputs
Unit/Tag	Select unit or tag to be displayed	Unit	Unit, Tag, Both (tag and unit) Only 04CH (03CH)+Bar display mode is valid. For 1 pen type and 2 pen type display become [*] and unable to set.
Auto/Const	Select either manual (key) or auto (update interval) for display CH update	Auto	Auto, Const
CH-Update Interval	Set update interval of display CH	2sec	1sec, 2sec, 3sec, 5sec, 10sec, 30sec
Data-update interval	Set data update interval.	0.1s	0.1s, 0.2s, 0.5s, 1s
Display Backlight	Select ON or AUTO for LCD backlight With AUTO selected, LCD backlight is turned off after three minutes of unused period.	ON	ON (always ON), AUTO
Display Backlight Level	Select brightness of backlight	5	1 (dark) to 5 (light)
Chart Illumination	Select ON, OFF or AUTO for chart illumination With AUTO selected, chart illumination is turned off after three minutes of unused period.	ON	ON (always ON), AUTO, OFF
Chart Illumination Level	Select brightness of chart illumination	5	0 (OFF) to 5 (light)
Display-order	Select whether to display measured value in chronological order of CH No. or arbitrary order.	OFF	ON (arbitrary order), OFF (chronological order of CH No.)

8-24. Measured Value Display Order Settings “D.Order”

The order of CH update can be changed for measured value display. Setting is only available at multiple pen type.

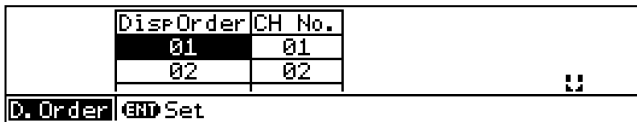
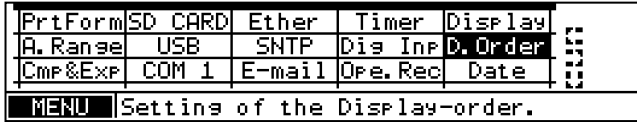

(1) Pressing the **MENU** key displays the menu window (list of setting items).

(2) Select “D.Order”.

(3) Set CH No. to create a desired order of update (display) from 01 to 04.

(4) Press the **ENTER** key to make it available for setting and then enter CH No.

(5) After completing the setting of this item, move the cursor to **Set**.

(6) Press the **ENTER** key to register the setting (when chart recording is ON, a setting change mark is printed). To cancel the setting, press the **ESC** key.

[D.Order setting parameter]

Parameter	Function	Default	Set value
CH No.	Set CH No. to be updated (displayed)	1 to 4	- (Skipped with 1-CH display, blank display with multiple channel display), 1 to 4

8-25. Date and Time Settings “Date”

The unit is equipped with a clock which indicates “year/month/day/hour/minute/second”. The time has been set prior to shipment. Reset it when needed.

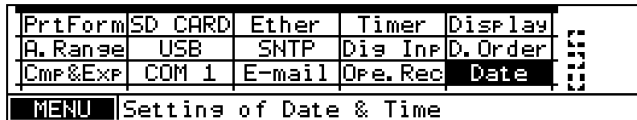

(1) Pressing the **MENU** key displays the menu window (list of setting items).

(2) Select “Date”.

(3) Move the cursor to the parameter to be set with the **▲/▼/◀/▶** keys.

(4) Press the **ENTER** key to make it available for setting and then enter a value.

(5) After completing the settings of this item, move the cursor to **Set**.

(6) Press the **ENTER** key to register the settings (when chart recording is ON, a setting change mark is printed). To cancel the settings, press the **ESC** key.

[List of Date setting parameters]

Parameter	Default	Set value
Year	Current time has been set.	2000 to 2099
Month		Jan 1 to Dec 31
Day		00:00:00 to 23:59:59
Hour		
Min		
Sec		

8-26. System Settings “System”

The system related settings such as enabling/disabling settings are available.

1. Enabling and disabling settings

By entering a password, you can “disable a setting change by keys (Key Lock)”, “clear memory (Initialize)”, “disable/enable zero or span adjustment for printing position (Adjust of Rec position)” or “disable/enable input adjustment (Input Correction)”. Set these items as a recovery process when the unit does not function properly due to misoperation or other reasons.

Note 1 Default password

The default password is “3571”. This password cannot be changed.

Note 2 Memory clear

When the memory clear (Initialize) is executed, parameters will be reset to default values. This cannot initialize the adjustment data (zero/span calibration) and soft dip information.

Note 3 Key operation

When Key Lock is enabled, settings of all items cannot be changed. The message “Key locking” is displayed when you try to register a parameter. However, checking of setting items is available.

2. Output mode settings

Alarm output mode can be set. The settings are common to all relay No. Default setting is Norm.Open mode (normally non-excitation state, at the alarm activation excitation state). Terminal configuration differs depending on the alarm output specification.

1) Mechanical relay ‘a’ contact output

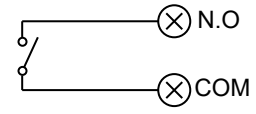
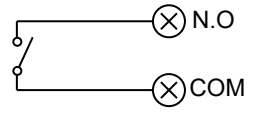
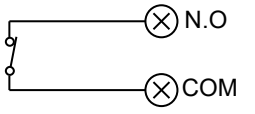
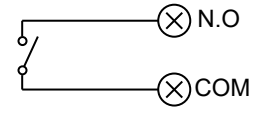
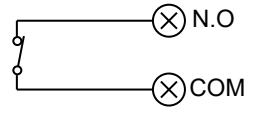
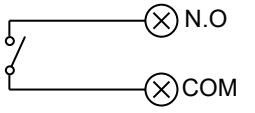
Relay mode	Power OFF	Alarm reset	Alarm activation
Norm.Open			
Norm.Close			

2) Mechanical relay ‘c’ contact output

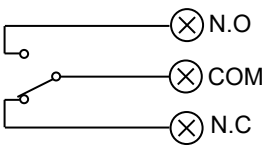
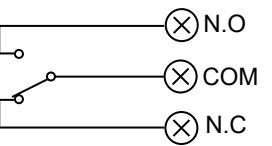
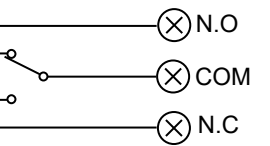
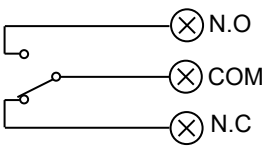
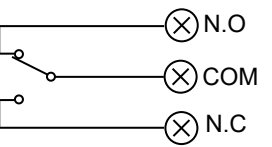
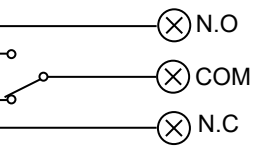
Relay mode	Power OFF	Alarm reset	Alarm activation
Norm.Open			
Norm.Close			

3. Parameter settings

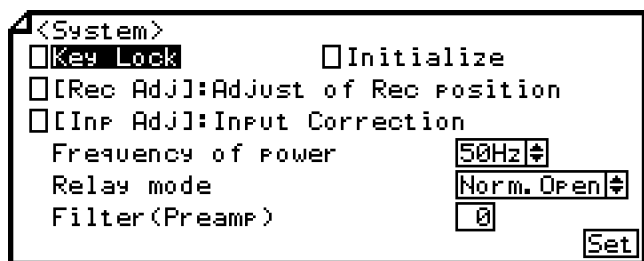
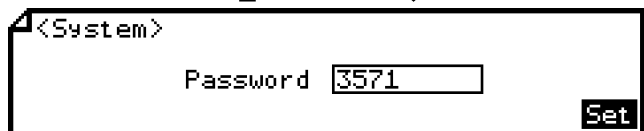
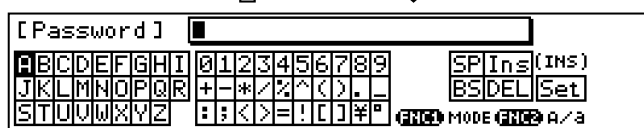
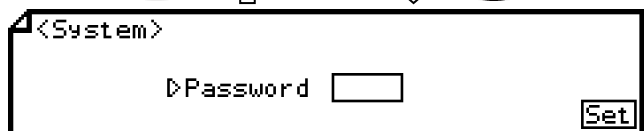
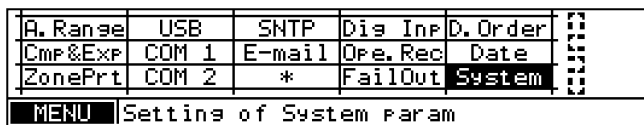

Note: Actual windows are separated. Use the ▲/▼ keys to scroll and continue settings.

- (1) Pressing the **MENU** key displays the menu window (list of setting items).
- (2) Select "System".
- (3) Pressing the **ENTER** key opens the password entry window.
- (4) Enter a password. After that, move the cursor to **Set** and press the **ENTER** key.
- (5) When password entry is completed, move the cursor to **Set** and press the **ENTER** key.
- (6) Move the cursor to the parameter to be set with the ▲/▼/◀/▶ keys.
- (7) For enabling and disabling, press the **ENTER** key and check the desired item. For the other parameters, press **ENTER** to set, then select a value or input.
- (8) After completing the settings of this item, move the cursor to **Set**.
- (9) Press the **ENTER** key to register the settings (when chart recording is ON, a setting change mark is printed). To cancel the settings, press the **ESC** key. Press the **ENTER** key to display "****Start Initializing?****" then press **FUNC1** key to execute memory clear. To cancel the settings, press the **ESC** key.

[System setting parameters]

Parameter	Function	Default	Set value
Key Lock	Set disabling settings change by key.	Not set	Select at checkbox.
Initialize	Set memory clear.	Not set	Select at checkbox.
[Rec Adj] : Adjust of Rec position	Disable/enable zero or span adjustment for printing position.	Not set	Select at checkbox.
[Inp Adj] : Input Correction	Disable/enable input adjustment.	Not set	Select at checkbox.
Frequency of power	Set power frequency.	50Hz	50Hz, 60Hz
Relay mode	Set alarm output mode.	Norm.Open	Norm.Open (non-excitation), Norm.Close (excitation)
Filter (Preamp)	Set strength of the filter.	0	0 to 10

8-27. System Information Display “SysInfo”

The system information display shows the model, serial number, software version of CPU used (for preamplifier, printer and other application), MAC address (Ethernet specification only) and status of system.



Cmp&Exp	COM 1	E-mail	Op.e. Rec	Date	[F1] [F2] [F3] [F4]
ZonePrt	COM 2	*	FailOut	System	
*	*	*	*	SysIn fo	
[MENU] Information of this System					

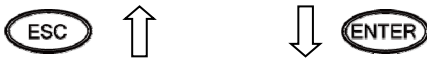

TYPE:	No. :		
MAC Adr. :			
SP:	System Value:		
P:	A:	E:	I:
S1:	S2:	S3:	S4:
ALM1:	ALM2:	ALM3:	ALM4:
Battery:			

(1) Pressing the **MENU** key displays the menu window (list of setting items).

(2) Select “SysInfo”.

(3) Pressing the **ENTER** key displays the system information.

Item	Contents
TYPE	Model code of the unit (“-” excluded)
No.	Serial number of the unit
MAC Adr.	MAC address of the unit using Ethernet option * This field is left blank when Ethernet option is not used.
SP	Additional information (0X00000000 displayed normally)
System Value	Value depends on the unit specification
P	Printer software version
A, E	Application software version
I	Preamplifier software version
S1 to S4	Analog pen control part software version
ALM1 to ALM4	Alarm unit software version
Battery	Clock backup voltage

8-28. Soft Dip Switch Settings “SoftDip”

ON/OFF of each printing setting and function are switched. Turn off the power after the setting in order to reflect the setting. This is not initialized. It is different from contents of soft dip switch setting on setting software.



COM 1	E-mail	Ope. Rec	Date	*
COM 2	*	FailOut	System	SoftDip
LOW COM	*	SDtoPrt	SysInfo	*

MENU SoftDipSW ㊦



No.	ON/OFF	Item
U01	OFF	Language:Japanese
U02	ON	Rec ON Feed:Yes
U03	ON	Rec ON DatePrint:Yes
U04	OFF	Rec ON DateFormat:Normal
U05	OFF	Rec OFF DatePrint:No
U06	OFF	Time Print Format:Normal
U07	ON	Fixed Time Print:Yes
U08	ON	Time Print:Yes
U09	OFF	DataInterval Format:Normal
U10	ON	Feed After Date:Yes
U11	ON	Time of message:Yes
U12	OFF	Decimal point(SD):.
U13	OFF	Rec OFF DATAP:No
U14	OFF	DI Logic:Normal

SoftDIPSW ㊦ ON/OFF

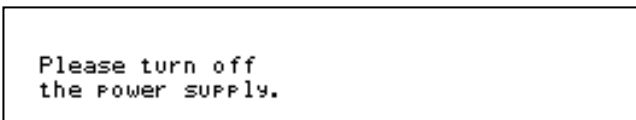
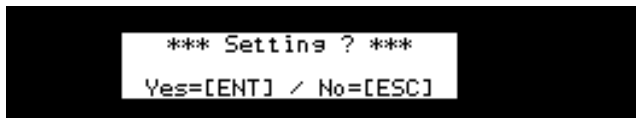

(1) Pressing the **MENU** key displays the menu window (list of setting items).

(2) Select “SoftDip”.

(3) Move the cursor to the parameter to be set with the **▲/▼** keys.

(4) Pressing the **ENTER** key switches ON/OFF.

(5) Pressing the **ESC** key displays the confirmation screen. Press the **ENTER** key to register the settings. The confirmation screen is displayed regardless of setting change.

(6) Turn off the power after the setting in order to reflect the setting.

No.	Display contents of ON/OFF selecting	Contents of setting	Factory default
U01	OFF Language: Japanese ON Language: English	Display language OFF Japanese ON English	OFF
U02	OFF Rec ON Feed: No ON Rec ON Feed: Yes	5mm feed when recording is started OFF No feed ON Feed	ON
U03	OFF Rec ON DatePrint: No ON Rec ON DatePrint: Yes	Print year, month, day, and time when recording is started OFF No print ON Print	ON
U04	OFF Rec ON DateFormat: Normal ON Rec ON DateFormat: Special	Switch format of year, month, and day when power turns on, recording is started, and recording is finished. OFF Year, month, day, hour, minute ON Year, month, day	OFF
U05	OFF Rec OFF DatePrint: No ON Rec OFF DatePrint: Yes	Print year, month, day, and time or not when recording is finished OFF No print ON Print	OFF
U06	OFF Time Print Format: Normal ON Time Print Format: Special	Switch time format of fixed time printing OFF Hour, minute ON Year, month, day, hour, minute	OFF
U07	OFF Fixed Time Print: No ON Fixed Time Print: Yes	Print fixed time (except time line and time printing) OFF No print ON Print	ON
U08	OFF Time Print: No ON Time Print: Yes	Print time line and time printing of fixed time printing OFF No print ON Print	ON
U09	OFF DataInterval Format: Normal ON DataInterval Format: Special	Switch time format of periodic data printing OFF Hour, minute ON Year, month, day, hour, minute	OFF
U10	OFF Feed After Date: No ON Feed After Date: Yes	5mm feed after year, month, and day printing when power turns on OFF No feed ON Feed	ON
U11	OFF Time of message: No ON Time of message: Yes	Message print with additional information (Message No., hour, and minute) OFF No information ON With information	ON
U12	OFF Decimal point (SD): . ON Decimal point (SD): ,	Decimal point position character of storing to SD card (TEXT format) OFF . (Period) ON , (Comma)	OFF
U13	OFF Rec OFF DATAP: No ON Rec OFF DATAP: Yes	Data print when recording is finished. OFF No print ON Print	OFF
U14	OFF DI Logic: Normal ON DI Logic: Reverse	Logic reverse of external contact signal OFF Normal ON Reverse	OFF

Note Saving setting parameters to the SD card and loading setting parameters from the SD card

Setting parameters of soft dip switch can not be saved to the SD card and so they can not be loaded from the SD card either.

9. Adjustment

The unit provides four adjustment functions. Perform a suitable adjustment depending on the situation. All adjustments are processed in the software and mechanical adjustment such as trimmer adjustment is not necessary.

Available adjustments are “trace printing position adjustment”, “input (measurement) adjustment”, “input (measurement) shift adjustment” and “recording position (time) adjustment”.

9-1. Trace Printing Position Adjustment “Rec Adj”

Perform zero/span adjustment for cartridge pen and plotter pen position on a chart. This adjustment does not affect the measured value. Before performing this adjustment, enable “Adjust of Rec position” according to “8-26. System Settings”. When it is enabled, “Rec Adj” is shown on the menu window (list of setting items).



(1) Pressing the **MENU** key displays the menu window (list of setting items).

(2) Select “Rec Adj”.

(3) Set pen No. with the ▲/▼ keys. Each time pressing the ▼ key changes Pen1 → Pen2 → Pen3 → Pen4 → Plot. (plotter pen). The zero and span values currently set are shown on this window. These values are replaced by new values, when the **ENTER** key is pressed after completing the adjustments.

(4) Press the **FUNC1** key to select zero, or the **FUNC2** key to select span.

[Zero adjustment]

```
<Rec Adj> Zero Adj
Zero=0400 Position=0410
ESC Stop ←-1 →+1 ENT Set
```

- (5) Pressing the **FUNC1** key moves the pen to the zero side and pen recording starts while feeding the chart.
- (6) Move the pen with the **←/→** keys so that pen recording is aligned to the chart 0% position.
- (7) When the adjustment is completed, press the **ENTER** key to register the zero position.

[Span adjustment]

```
<Rec Adj> Span Adj
Span=1270 Position=1270
ESC Stop ←-1 →+1 ENT Set
```

- (5) Pressing the **FUNC2** key moves the pen to the span side and pen recording starts while feeding the chart.
 - (6) Move the pen with the **←/→** keys so that pen recording is aligned to the chart 100% position.
 - (7) When the adjustment is completed, press the **ENTER** key to register the span position.
- (8) While the adjustment window is displayed, you can perform adjustment by pressing the **FUNC1** key or **FUNC2** key as many times as you need. When the adjustment is completed, press the **ESC** key to exit the trace printing position adjustment.

Reference Pens other than set pen No.

Pens stand by near the center.

Note 1 Dotting at zero/span side

Unless the **←/→** key is pressed, dotting at 0% or 100% position is performed using the currently set adjustment data. When adjustment is not necessary, just press the **ESC** key.

Note 2 Zero/span individual adjustment

Zero and span can be adjusted separately. To adjust the 0% position only, press the **ESC** key when the adjustment is completed.

9-2. Recording Posotion (time) Adjustment

When the time-axis synchronization (POC) is programmed to "ON", the gaps between the pens may change over time, resulting in error between their time-axis. "Recording Position (time) Adjustment" is for correcting these changes.



SD CARD	Ether	Timer	Display	Rec Adj
USB	SMTP	Dis Inf	D. Order	TmAxAdj
COM 1	E-mail	Ope. Rec	Date	Inf Adj
MENU Adjust of record position(time).				



Rec position(time) Pen1
Pos. 0000
TmAxAdj FUNC1 Start



<TmAxAdj>	
Org. 0000	Position=0000
Stop	+1 +1(Slow) Set

Ref 2 Adjusting pen selection

Display	Reference pen	Pen to be adjusted
Pen1	Plotter pen	1 st pen
Pen2	1 st pen	2 nd pen
Pen3	1 st pen	3 rd pen
Pen4	1 st pen	4 th pen

Ref 1 Pen other than pen No. being adjusted

Pens stand by at 0% position.

Adjustment procedure

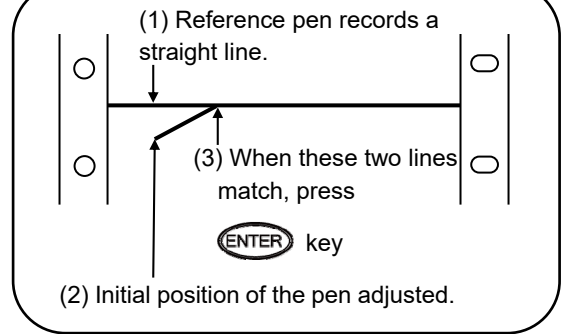

(1) Pressing the **MENU** key displays the menu window (list of setting items).

(2) Select "TmAxAdj".

(3) Set pen No. to correct (adjust) with the ▲/▼ keys. For four pen type, each time pressing the ▼ key changes Pen1 → Pen2 → Pen3 → Pen4. Press **FUNC1** key to start adjustment.

Adjustment values currently set are shown on this window. These values are replaced by new values, when the **ENTER** key is pressed after completing the adjustments.

(4) At first, reference pen record a straight line on the chart paper.

Pressing the ▼ key feeds the chart and moves cartridge pen little to the right. A cross point of a straight line recorded by a reference pen and a trajectory of the cartridge pen is adjustment ending point. Pressing

(5) After completing the adjustment of this item, press **ENTER** key to register the recording position.

(6) Press **ESC** key to complete pen recording position adjustment (time).

9-3. Input Adjustment “Inp Adj”

Perform scale calibration to improve accuracy which may be degraded by the surrounding environment or over time. Zero/span adjustment is performed for input (measured) data of each channel. Before performing this adjustment, enable “Input Correction” according to “8-26. System Settings”. When it is enabled, “Inp Adj” is shown on the menu window (list of setting items).



(1) Pressing the **MENU** key displays the menu window (list of setting items).



(2) Select “Inp Adj”.

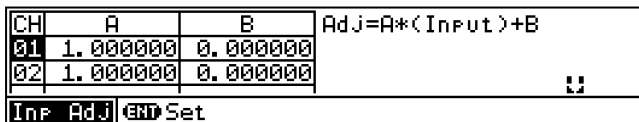

(3) Move the cursor to the target channel with the Δ/∇ keys and press the **ENTER** key. The cursor does not move to parameters other than CH. A tester should be connected to the target channel beforehand.

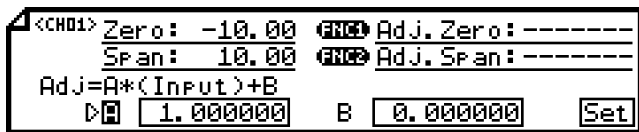

(4) The Zero and Span fields show respectively the range lower limit and range upper limit set in “8-2. Input Type Settings”.

[Zero input]

- (5) Apply the range lower limit specified in the Zero field by the tester.
- (6) Press the **FUNC1** key to take the input.

[Span input]

- (7) Apply the range upper limit specified in the Span field by the tester.
- (8) Press the **FUNC2** key to take the input.

- (9) When zero and span inputs are completed, correction values will be displayed automatically at “A” and “B”. It is also possible to enter values directly to A (tilt) and B (intercept) using the $\Delta/\nabla/\leftarrow/\rightarrow$ keys if you know these values.
- (10) After completing the settings of this item, move the cursor to **Set**.
- (11) Press the **ENTER** key to register the settings. To cancel the settings, press the **ESC** key.

Note 1 Attach terminal cover

The temperature of terminal varies when it is exposed to wind. Attach the terminal cover especially when using thermocouple input.

Note 2 For instrument safety

Energize the unit for at least 30 minutes before performing an adjustment.

9-4. Input Shift Adjustment

The amount of shift (parallel shift) for input (measurement) data can be adjusted. This adjustment is intended mainly to correct variance in sensor or input converter.

The adjustment can be performed for each channel. There are two types of setting as described below.

1. Set shift value in input type settings

After setting, measured value will be shifted by the specified amount.

(See "8-2. Input Type Settings".)

Example of shift setting

Shift a measured value 850.3 to a set value 850.0 ($850.0 - 850.3 = -0.3$).

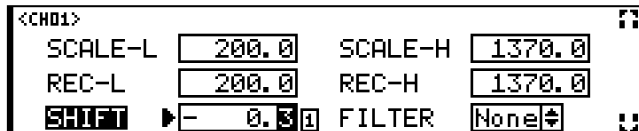

- (1) Display the input type settings window shown on the left, and enter "-0.3" to the SHIFT entry field.
- (2) After completing the setting, move the cursor to **Set**.
- (3) Press the **ENTER** key to register the setting. To cancel the setting, press the **ESC** key.

2. Set shift value with "Inp Adj" described in the previous section

(See "9-3. Input Adjustment".)

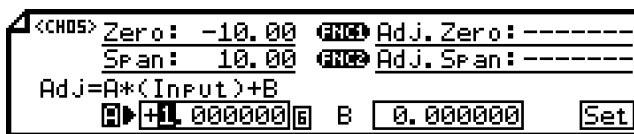

- (1) Display the input adjustment window shown on the left, and enter "1" to the A parameter entry field and a shift value to the B parameter entry field.
If an input adjustment has already been performed and values have been specified in the A and B fields, add a shift value to the B parameter.
- (2) After completing the setting, move the cursor to **Set**.
- (3) Press the **ENTER** key to register the setting.
To cancel the setting, press the **ESC** key.

Note 1 Double setting

When shift value is set on the input type settings window and also on the input adjustment window, the actual shift value will be the sum of the two set values.

Note 2 Relation with input adjustment

To set a shift value using the input adjustment described in the previous page, the SHIFT on the input type settings window should be set to "0".

Note 3 For instrument safety

Energize the unit for at least 30 minutes before performing an adjustment.

9-5. Wiring and Environment for Input Adjustment

1. Preparation

- (1) Turn OFF the power switch and perform the wiring depending on the input signal (see the figure below). Connect to the input terminal of the adjustment target channel.
- (2) Attach the terminal cover.
- (3) Turn ON the power switch and select the 1-point display (fixed) mode.
- (4) Display the adjustment target channel.
- (5) Energize the unit for at least 30 minutes (an hour or more is ideal) and then perform an adjustment.

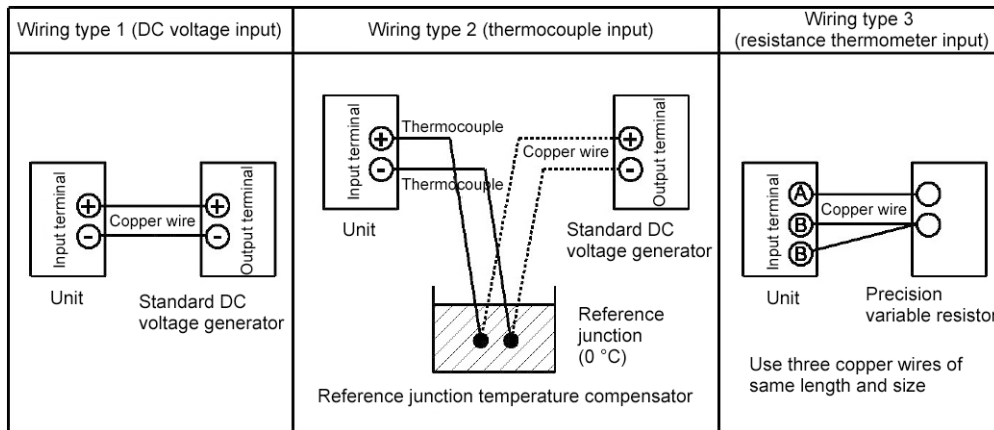

Note 1 Tester accuracy

The accuracy of the unit is $\pm 0.1\%$. Therefore, you need to use a tester having higher degree of accuracy to perform proper adjustment. Also, attention should be paid to the thermocouple error. Note that a tester requires time to be stabilized to ensure its accuracy and stability.

Note 2 Reference junction compensator

Make sure that the reference junction temperature is 0°C . When using an electronic reference junction compensator, read its instruction manual. Also, the compensation accuracy should be checked.

Note 3 When reference junction temperature compensator (RJ) is not available

When you use thermocouple input and set RJ to "INT", perform the type 1 wiring if a reference junction temperature compensator is not available. In this case, set RJ to "EXT" during adjustment only. Note that error correction of reference junction temperature compensation cannot be performed.

2. How to adjust

- (1) Set a tester (standard DC voltage generator or precision variable resistor) to an input value equivalent to the adjustment target value.
- (2) At this time, read the digital display and check if the error is within the specified accuracy range.
- (3) Next, change to the adjustment target channel and adjust it likewise.
- (4) Adjust also the trace printing position.

- * The accuracy of the unit is rated at an ambient temperature of $23^{\circ}\text{C} \pm 2^{\circ}\text{C}$. Ensure safety of the surrounding environment.
- * When using the shift adjustment function to adjust measured value, the shifted value should be taken into account.
- * When you change the wiring with the terminal cover removed, energize the unit for at least 30 minutes after attaching the terminal cover and then perform adjustment.

10. Engineering Port (Mini-USB Terminal)

An engineering port is provided in the front section of the unit to allow connection to a personal computer. This port is provided to all models as a standard feature.

Use a mini-USB cable to connect to a personal computer.

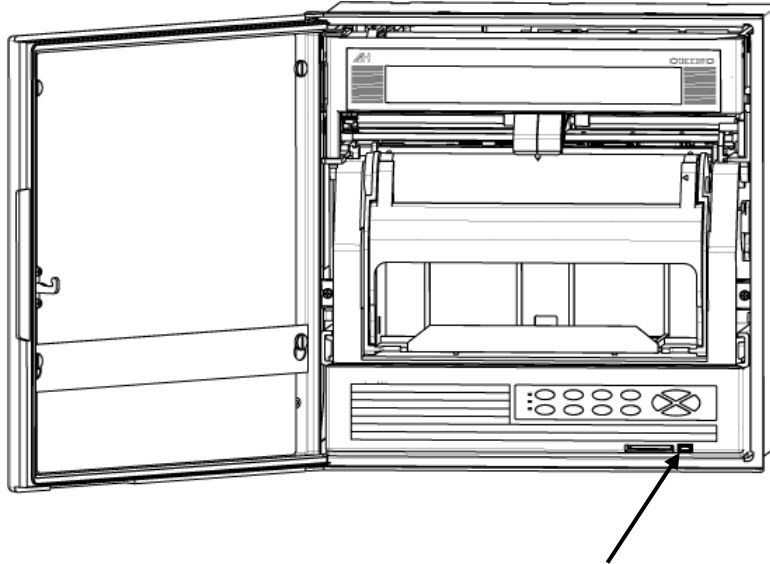

Engineering port (mini-USB)

Note that this engineering port is designed for temporary communication connection and not intended for always-on connection. To obtain always-on connection for communication, you need to request the model with communication interface at the time of purchase, and use the terminal located at the rear side of the unit for permanent connection.



Caution







Make sure to attach or remove an engineering cable to/from the engineering port while the unit is turned on.

11. Troubleshooting

11-1. Problems and Remedies

The following table lists problems that may occur on the unit (operations and functions) with description of the symptoms, their possible causes and remedies.

 Warning	<p>Never replace parts to repair or modify the unit. Not only does it fail to repair or modify, but it also may cause electric shock or damage to the unit.</p>
--	---

Symptom	Cause/Remedy
(1) Unit does not function even the power switch is turned ON	(1) Check the wiring to the power terminal. (See "4-3.3. Power/protective conductor terminals wiring".) (2) Make sure that the power voltage is AC100 to 240V.
(2) Noise produced as printer moves	(1) Check if the cartridge pen is attached properly. (See "6-1.2. How to set plotter pen and cartridge pen".) (2) Open the unit door and check the printer moving area for foreign matter. Remove it if exists.
(3) Data displayed but not recorded	(1) Make sure that the recording is ON ("REC" status LED lights up). (See "6-2.4. Chart recording operation".) (2) Check if the ribbon cassette is attached properly. (See "6-1.2. How to set plotter pen and cartridge pen".) (3) Check if the chart is attached properly or if it has run out ("REC" status LED flashes). (See "6-1.1. How to set chart paper".)
(4) Chart does not move as printer moves	(1) Feed the chart paper manually and make sure that the chart can be fed smoothly. (2) Make sure that the chart can be fed smoothly with the  key. (See "6-2.4. Chart recording operation".)
(5)  ,  ,  keys not accepted	Check the system settings. (See "8-26. System Settings".) While Key Lock is active,  is shown on the display.
(6) Range setting done, but data display or trace/digital printing not performed on a certain channel	(1) Check the setting (ON/OFF) of each operation in input type settings. (See "8-2. Input Type Settings".)
(7) Parameters set correctly, but not reflected on the window when checked	When a setting is changed while the chart recording is ON, a setting change mark is printed on a chart. Check the chart to see if it is printed. If not, the following situation is a possible cause. You have not pressed the  key after moving the cursor to  , or there was an error in the set contents.
(8) Parameters set correctly, but normal display does not return	
(9) Periodic data printing set, but not executed	(1) The start time set for periodic data printing has not come yet. (2) Parameters are not set correctly. (See "8-10 and 8-11. Periodic Data Printing Settings".) * When you specify a start time which is earlier than the time of setting, periodic data printing will be executed from the next day at the specified time.
(10) Malfunction occurred unpredictably without warning	Initialize setting parameters. (See "8-26. System Settings".) When the unit is recovered, set parameters again and see how it works.

11-2. Abnormal Measured Value

Symptom	Cause/Remedy
(1) Unstable measured value	(1) Check if the measuring terminal is loose. (2) Check if the input signal is unstable. (3) Make sure to avoid the following condition: BURN is set to other than "None" while connecting a thermocouple in parallel with another instrument.
(2) Measured value display shows the followings: OVER, BURN, etc.	(1) Make sure that the wiring to the input terminal is properly done. (2) Check if the input terminal is loose. (3) Check if the input line is disconnected. (4) Check if the input signal is out of the measuring range.
(3) Error occurs in measured value	(1) Check if error occurs in the input signal. (2) Make sure that a compensation lead wire is connected to the input terminal (thermocouple input only). (3) Check the scale and perform input adjustment if error occurs.
(4) Measured value influenced by ambient temperature (thermocouple input only)	(1) Check if RJ is set to "EXT" (external) in input type settings (this is not a problem if reference junction compensation is performed externally). (2) Make sure that the terminal cover is attached.

Important notice

If the troubleshooting does not help solving the problem, immediately contact the dealer or your nearest CHINO office and give the following information.

(1) MODEL (2) Serial number (3) Problem (4) Other concerns

12. Inspection and Maintenance

12-1. Routine Inspection

Check the remaining amount of chart and recording condition on a daily basis to keep the unit in good condition. When any abnormality is found, take an appropriate action according to the "11. Troubleshooting".

Maintenance/inspection item	Operation
Plotter pen and cartridge pen replacement	When the trace printing (trend line) fade away or becomes less visible, replace the cartridge pen with new one. When the letters of digital printing fade away or become less visible, replace the plotter pen with new one. (See "6-1.2. How to set plotter pen and cartridge pen".)
Chart replacement	A chart paper can last about a month when fed at a speed of 25mm/H continuously. When the end of chart nears, an end mark (red line on the right edge of chart) appears. In this case, replace the chart with new one. (See "6-1.1. How to set chart paper".)
Cleaning	Wipe away dirt on the unit with a soft, dry cloth or a cloth dampened with warm water or neutral detergent.



Caution

Do not use chemical solvents including thinner and benzene to prevent the unit surface from melting. The chart guide is made of acrylic. It may produce a crack when a chemical solvent is used.



Caution

Do not lubricate the mechanical section such as the main shaft and gear.

12-2. Consumable Parts and Replacement Guideline

The unit includes some consumable parts. To use the unit for a long time in good condition, we recommend that these parts be replaced regularly.



Warning

Do not replace parts other than chart and pens by yourself. Not only does it fail to replace properly, but it also may pose dangerous situation. Make sure to contact CHINO's sales agent for replacement of consumable parts.

1. Consumable parts and recommended replacement cycle

(Usage under the condition of temperature: 20 to 25°C, humidity: 20 to 80%RH, operation time: 8hours/ a day)

Consumable part		Replacement cycle	Other operating condition
Mechanical parts	Pen servo (for cartridge pen)	4 to 6 years	Use under the normal condition as below: <ul style="list-style-type: none"> • No corrosive gas • Dust free, oil smoke free, dry place • Free from vibration and impact • No other factors affecting operation
	Pen servo (for plotter pen)	4 to 6 years	
	Belt	4 to 6 years	
	Chart drive mechanism	4 to 6 years	
	Motors	4 to 6 years	
Electronic parts	Power supply	5 years	At an ambient temperature of 25°C
	Relay (for alarm)	100,000 times	Resistive load
		30,000 times	Inductive load
	Lithium battery	10 years	8-hour operation per day (at an ambient temperature of 40°C or lower)
	Keys	500,000 times	Depends highly on the use and surrounding conditions.
Display (LCD)	4 to 6 years	At an ambient temperature of 25°C	

12-3. Battery removal method for the purpose of disposa



Caution

Do not replace the battery. Doing so might cause damage or malfunction.
Do not remove the battery except when disposing the recorder.

1. Removing the battery

- 1) Removing the internal chassis
 - (1) Open the unit door and then open the display board in the same direction.
 - (2) Turn OFF the power switch.
 - (3) Remove two screws fixing the internal chassis.
 - (4) Remove one screw fixing the mechanical side panel and then pull out the internal chassis.
 - (5) Remove chassis back side cable.
 - (6) Remove two Chassis front unit fixing screw and pull out chassis front unit.

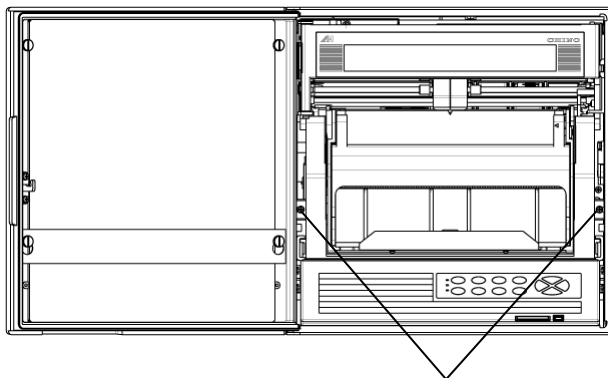

Internal chassis fixing screw

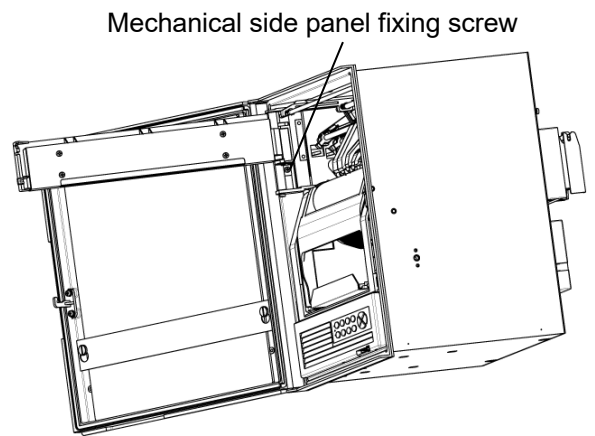

Mechanical side panel fixing screw

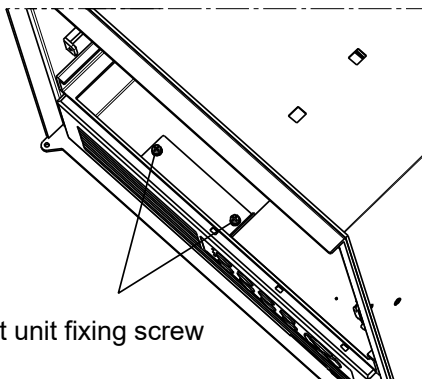

Chassis front unit fixing screw

2) Removing the battery

(1) The battery is located at the back of the chassis front unit.

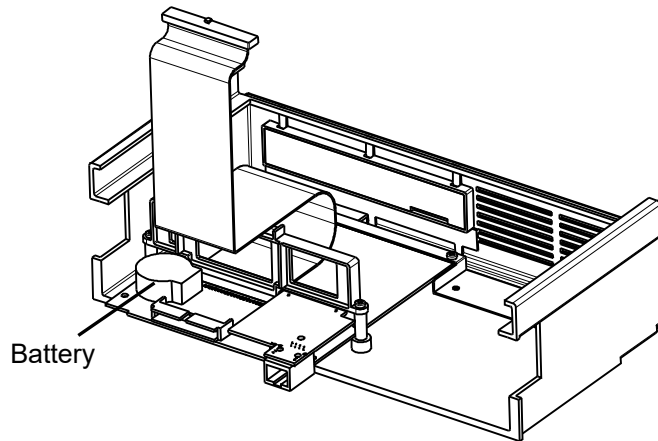

(2) Using a tapered, insulated tool, remove the battery from the battery holder.

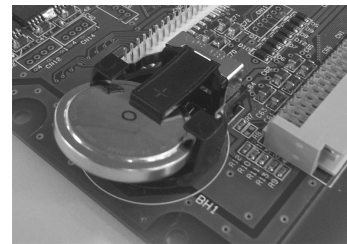
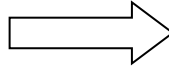
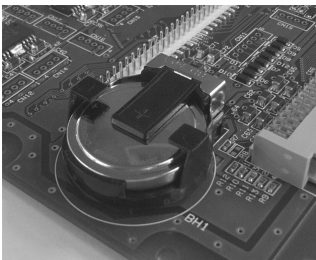

 Caution	<ul style="list-style-type: none">(1) The unit components include a small amount of harmful chemical substance no more than the defined amount by RoHS.(2) The unit must be disposed of by a waste disposal company or in accordance with the local regulations.(3) The unit uses a lithium battery and the battery must be disposed of by a waste disposal company.(4) The packing materials used for the unit, such as box, plastic bag, cushion and sticker, should be sorted for recycling in accordance with local regulations.
--	---

13. Option

13-1. External Operation Settings “Dig Inp”

Using remote contact signal (no-voltage contact: short or open), selection of chart speed or data printing can be executed without operating keys at the operation/set keys section. To use this function, you need to allocate operation to a terminal number. Some operations are allocated automatically to specific terminal numbers.

1. Names of the operations executed externally

Operation name	Terminal used
(1) Select chart speed from three speeds	EX1 and EX2 terminals
(2) Message printing (No.01 and 02)	EX1 and EX2 terminals
(3) Message printing (No.01 to 05)	EX1 to EX4 terminals
(4) Data printing	One arbitrary terminal (multiple selection available)
(5) List printing (List No.1, 2 and 3)	One arbitrary terminal (multiple selection available)
(6) Integration value reset	One arbitrary terminal (multiple selection available)
(7) Message printing (No.01 to No.20)	One arbitrary terminal (multiple selection available)
(8) Time correction	One arbitrary terminal (multiple selection available)

2. Operation and terminal contact signal

1) Operations allocated automatically to specific terminal numbers

ON: short OFF: open

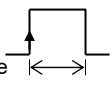
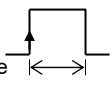
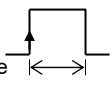
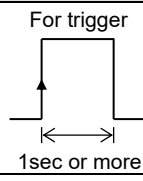
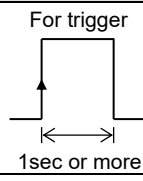
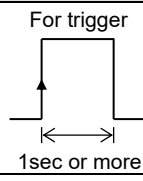
Operation name	Terminal contact signal																														
(1) Select chart speed from three speeds	<p>Three chart speeds should be set as well as the setting described in this section. (See “8-7. Chart Speed Settings”).</p> <table border="1"> <thead> <tr> <th rowspan="2">Recording ON/OFF and chart speed selection</th> <th colspan="2">Between COM and EX □ terminal</th> </tr> <tr> <th>EX1</th> <th>EX2</th> </tr> </thead> <tbody> <tr> <td rowspan="3">Recording ON</td> <td>CS1</td> <td>OFF</td> </tr> <tr> <td>CS2</td> <td>ON</td> </tr> <tr> <td>CS3</td> <td>OFF</td> </tr> <tr> <td>Recording OFF</td> <td>ON</td> <td>ON</td> </tr> </tbody> </table> <p>Chart recording should be ON to enable chart speed selection.</p>	Recording ON/OFF and chart speed selection	Between COM and EX □ terminal		EX1	EX2	Recording ON	CS1	OFF	CS2	ON	CS3	OFF	Recording OFF	ON	ON															
Recording ON/OFF and chart speed selection	Between COM and EX □ terminal																														
	EX1	EX2																													
Recording ON	CS1	OFF																													
	CS2	ON																													
	CS3	OFF																													
Recording OFF	ON	ON																													
(2) Message printing (No.01 and 02)	<p>Message should be set as well as the setting described in this section. (See “8-13. Message Printing 1 Settings”).</p> <table border="1"> <thead> <tr> <th>Message No.</th> <th>Terminal</th> <th>For trigger</th> </tr> </thead> <tbody> <tr> <td>Message No.01</td> <td>COM and EX1</td> <td rowspan="2">  </td> </tr> <tr> <td>Message No.02</td> <td>COM and EX2</td> </tr> </tbody> </table> <p>A selected message will be printed when a trigger signal (1sec or longer) is given. Message printing can be executed also by keys.</p>	Message No.	Terminal	For trigger	Message No.01	COM and EX1		Message No.02	COM and EX2																						
Message No.	Terminal	For trigger																													
Message No.01	COM and EX1																														
Message No.02	COM and EX2																														
(3) Message printing (No. 01 to 05)	<p>Message should be set as well as the setting described in this section. (See “8-13. Message Printing 1 Settings”).</p> <table border="1"> <thead> <tr> <th rowspan="2">Message</th> <th colspan="4">Between COM and EX □ terminal</th> </tr> <tr> <th>EX1</th> <th>EX2</th> <th>EX3</th> <th>EX4*</th> </tr> </thead> <tbody> <tr> <td>No.01</td> <td>OFF</td> <td>OFF</td> <td>OFF</td> <td rowspan="5">  </td> </tr> <tr> <td>No.02</td> <td>ON</td> <td>OFF</td> <td>OFF</td> </tr> <tr> <td>No.03</td> <td>OFF</td> <td>ON</td> <td>OFF</td> </tr> <tr> <td>No.04</td> <td>ON</td> <td>ON</td> <td>OFF</td> </tr> <tr> <td>No.05</td> <td>OFF</td> <td>OFF</td> <td>ON</td> </tr> </tbody> </table> <p>* A selected message will be printed when a trigger signal (1sec or longer) is given after selecting message No. Chart recording should be ON to enable message printing. Message printing can be executed also by keys.</p>	Message	Between COM and EX □ terminal				EX1	EX2	EX3	EX4*	No.01	OFF	OFF	OFF		No.02	ON	OFF	OFF	No.03	OFF	ON	OFF	No.04	ON	ON	OFF	No.05	OFF	OFF	ON
Message	Between COM and EX □ terminal																														
	EX1	EX2	EX3	EX4*																											
No.01	OFF	OFF	OFF																												
No.02	ON	OFF	OFF																												
No.03	OFF	ON	OFF																												
No.04	ON	ON	OFF																												
No.05	OFF	OFF	ON																												

Operation name	Terminal contact signal
(4) Data printing	Turn ON the terminal No. specified for data printing. Chart recording should be ON. Data printing can be executed also by keys. While executing data printing, another execution request can be accepted.
(5) List printing (List No.1, 2 and 3)	Turn ON the terminal No. specified for list 1, 2 and 3 printing. Chart recording should be ON. List printing can be executed also by keys. (See "8-12. List Printing Settings".)
(6) Integration value reset	When "EX (All)" is selected for INT-Reset in calculation settings, integration value can be reset by turning ON the terminal No. specified for integration reset. (See "8-4. Calculation Settings".)
(7) Message printing (No.01 to No.20)	Message should be set as well as the setting described in this section. (See "8-13. Message Printing 1 Settings".) Turn ON the terminal No. specified for message printing (No.01 to 20). Chart recording should be ON. Message printing can be executed also by keys.
(8) Time correction	When the current time (second) is 0 to 30, the second value will be set to 0. When it is 31 to 59, the minute value will be increased by 1min and the second value will be set to 0. Example: Turn On the specified terminal No. at 10:10 and 30 seconds. The time will be set to 10:10:00. It will be 10:11:00 when the terminal is turned ON at 10:10 and 31 seconds.



Warning

For contact signal which is given to remote contact terminal, use a switch or relay operated at 30V AC, 60V DC or lower voltage level, or manually operated contact which can handle minute load.

3. Parameter settings



(1) Pressing the **MENU** key displays the menu window (list of setting items).

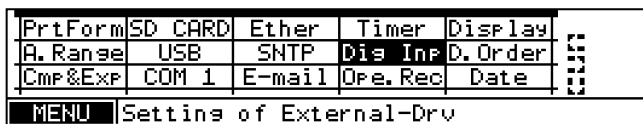

(2) Select "Dig Inp".

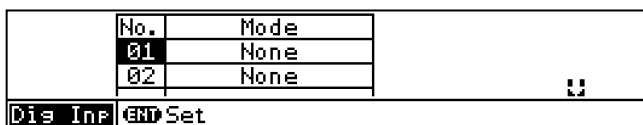

(3) Move the cursor to the target remote contact No. with the ▲/▼ keys and press the **ENTER** key. The cursor does not move to parameters other than No.

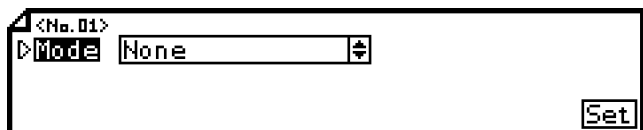

(4) Press the **ENTER** key to make it available for setting and then select a value.

(5) After completing the setting, move the cursor to **Set**.

(6) Press the **ENTER** key to register the setting (when chart recording is ON, a setting change mark is printed). To cancel the setting, press the **ESC** key.

[Dig Inp setting parameter]

Parameter	Function	Default	Set value
Mode	Allocate function to specified remote contact terminal No.	None	None (not used), ChartSpeed (chart speed), Message 1,2 (message 1 & 2 printing), Message 1to5 (message 1 to 5 printing), DataPrint, ListPrint 1 (list 1 printing), ListPrint 2 (list 2 printing), ListPrint 3 (list 3 printing), INT-Reset(All) (integration reset), Clock Adj (time correction), Message 1 (message 1 printing) to Message 20 (message 20 printing)

13-2. Operation Recording Settings “Ope.Rec”

The ON/OFF status of the remote contact input (No. 1 to 10: depending on the specification) can be recorded to chart. For a target remote contact No., specify the recording position for input OFF status (percentage value of chart span) and the recording position for input ON status by an offset (1 to 10mm) from the OFF position.

When the input is ON, recording is made on the right side of the input OFF recording position, at the position specified by an arbitrary offset width.

At this time, a straight line connects between ON and OFF.

Operation recording line and remote

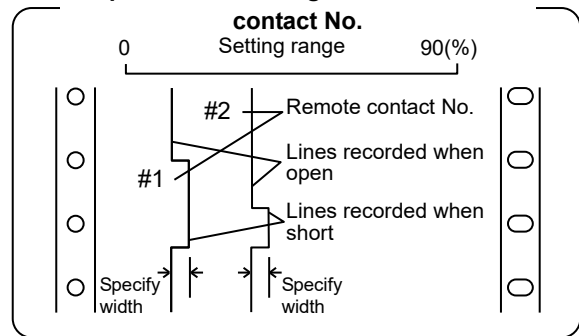

- (1) Pressing the **MENU** key displays the menu window (list of setting items).
- (2) Select “Ope.Rec”.
- (3) Move the cursor to the target remote contact No. with the **▲/▼** keys and press the **ENTER** key. The cursor does not move to parameters other than EX. Also, pressing the **FUNC2** key on this window displays the copy window for operation recording settings.
- (4) Move the cursor to the parameter to be set with the **▲/▼/◀/▶** keys.
- (5) Press the **ENTER** key to make it available for setting and then select or enter a value.
- (6) After completing the settings of this item, move the cursor to **Set**.
- (7) Press the **ENTER** key to register the settings (when chart recording is ON, a setting change mark is printed). To cancel the settings, press the **ESC** key.



PrtForm	SD CARD	Ether	Timer	Display	
A. Range	USB	SNTP	Dis Inp	D. Order	
Cmp&Exp	COM 1	E-mail	Ope. Rec	Date	
MENU Settings of Operation Record					

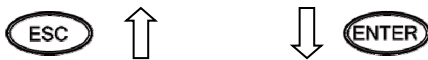

EX	ON/OFF	Position	Width	
01	OFF	-	-	
02	OFF	-	-	
Ope. Rec [ENTER] Set [FUNC2] Copy				



<No. 01>	
ON/OFF	OFF
Position	* %
Width	* mm
Set	

[List of Ope.Rec setting parameters]

Parameter	Function	Default	Set value
ON/OFF	Select ON or OFF for operation recording	OFF	ON (enabled), OFF (disabled)
Position	Set recording position for input OFF status to percentage of chart zero span	*	0 to 90 (%)
Width	Set recording position for input ON status to millimeters of chart zero span based on the input OFF recording position.	*	1 to 10 [mm]

13-3. COM Port Settings “COM1” and “COM2”

COM port 1 and COM port 2 can be set separately to use them simultaneously. These ports are mainly used to set the unit using PLC or PC, and load measured data.

This section describes the things related to settings only. For general handling information, refer to the instruction manual for “Communication Interface” provided separately.

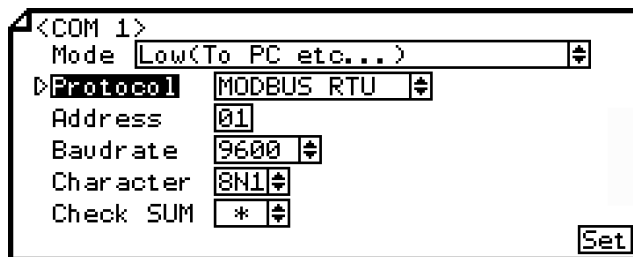

Note: Actual windows are separated. Use the ▲/▼ keys to scroll and continue settings.

(1) Pressing the **MENU** key displays the menu window (list of setting items).

(2) Select “COM1” or “COM2”.

(3) Move the cursor to the parameter to be set with the ▲/▼/◀/▶ keys.

(4) Press the **ENTER** key to make it available for setting and then select or enter a value.

(5) After completing the settings of this item, move the cursor to **Set**.

(6) Press the **ENTER** key to register the settings (when chart recording is ON, a setting change mark is printed). To cancel the settings, press the **ESC** key.

[List of COM1 and COM2 setting parameters]

Parameter	Function	Default	Set value
Mode	Communication mode	Low (To PC etc...)	Fixed to Low (To PC etc...)
Protocol	Select communication protocol	MODBUS RTU	MODBUS RTU, MODBUS ASCII, PRIVATE1 (without connection sequence), PRIVATE2 (with connection sequence)
Address	Set communication address of the unit	01	01 to 99
Baud rate	Set communication speed	9600	PRIVATE: 1200, 2400, 4800, 9600bps MODBUS: 9600, 19200, 38400bps Changes to “9600” when changing from PRIVATE to MODBUS or vice versa.
Character	Set transmission character	8N1	7E1, 7E2, 7O1, 7O2, 8N1, 8N2, 8E1, 8E2, 8O1, 8O2
Check SUM	Select whether to add checksum code	*	OFF, ON Settable only when Protocol is set to “PRIVATE”.

Reference Character selection

Codes are used to represent character type.

Code	Character length	Parity	Stop bit	Code	Character length	Parity	Stop bit
7E1	7-bit	Even	1	8N2	8-bit	Non	2
7E2	7-bit	Even	2	8E1	8-bit	Even	1
7O1	7-bit	Odd	1	8E2	8-bit	Even	2
7O2	7-bit	Odd	2	8O1	8-bit	Odd	1
8N1	8-bit	Non	1	8O2	8-bit	Odd	2

13-4. IP Address etc... Settings “Ether”

Set basic parameters necessary for communication using the Ethernet interface.

This section describes the things related to settings only. For general handling information, refer to the instruction manual for “Communication Interface” provided separately.

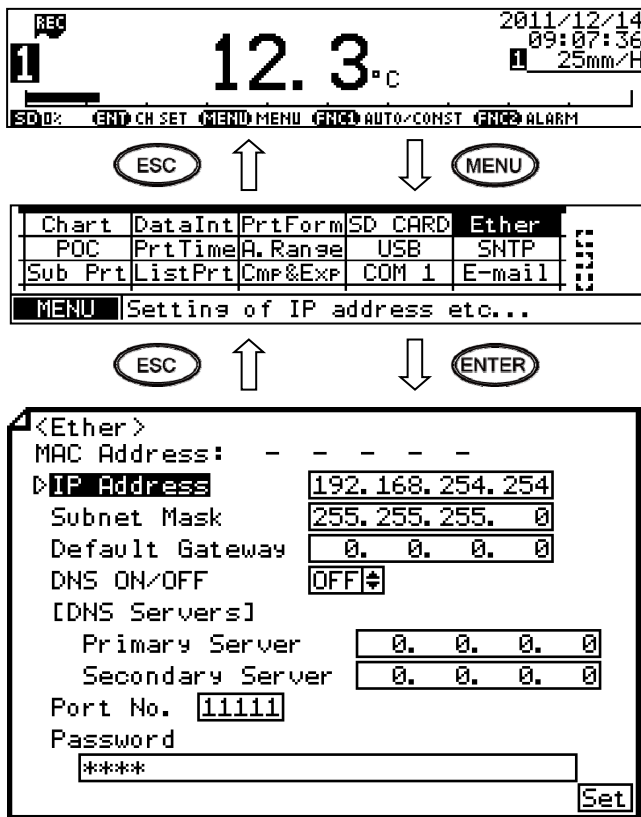

(1) Pressing the **MENU** key displays the menu window (list of setting items).

(2) Select “Ether”.

(3) Move the cursor to the parameter to be set with the **▲/▼/◀/▶** keys.

(4) Press the **ENTER** key to make it available for setting and then select or enter a value.

(5) After completing the settings of this item, move the cursor to **Set**.

(6) Press the **ENTER** key to register the settings (when chart recording is ON, a setting change mark is printed). To cancel the settings, press the **ESC** key.

Note: Actual windows are separated. Use the **▲/▼** keys to scroll and continue settings

[List of Ether setting parameters]

Parameter	Function	Default	Set value
MAC Address	Ethernet MAC address of the unit	Unique value	Setting disabled
IP Address	Set IP address	192.168.254.254	***.***.*** (each ** area is set to 0 to 255)
Subnet Mask	Set subnet mask	255.255.255.0	***.***.*** (each ** area is set to 0 to 255)
Default Gateway	Set default gateway address of the network used	0.0.0.0	***.***.*** (each ** area is set to 0 to 255)
DNS ON/OFF	Select whether to use DNS (domain name server)	OFF	OFF (not used), ON (used) Set server like SNTP and SMTP by the name when using DNS, or by the IP address when not using DNS.
[DNS Servers] Primary Server	Set primary DNS server	0.0.0.0	***.***.*** (each ** area is set to 0 to 255)
Secondary server	Set secondary DNS server	0.0.0.0	***.***.*** (each ** area is set to 0 to 255)
Port No.	Set port No. for socket communication by TCP/IP	1111	0 to 65535
Password	Set a password consisting of up to 32 characters used for setting on the Web	3571	

Reference Example settings for small network

To use the unit in a small network using a router without connecting to internal LAN or internet, set the IP address as shown below.

Unit	IP address	Subnet mask
SR-200 A	192.168.254.254	255.255.255.0
SR-200 B	192.168.254.253	255.255.255.0
...
PC A	192.168.254.1	255.255.255.0
PC B	192.168.254.2	255.255.255.0
...

13-5. SNTP Settings “SNTP”

Set SNTP related parameters for Ethernet interface. Specify whether or not to use SNTP, server to be used and query time. When SNTP is set to “ON”, a query is sent to the server according to the setting. When the time is obtained normally, it will be set automatically.

This section describes the things related to settings only. For general handling information, refer to the instruction manual for “Communication Interface” provided separately.

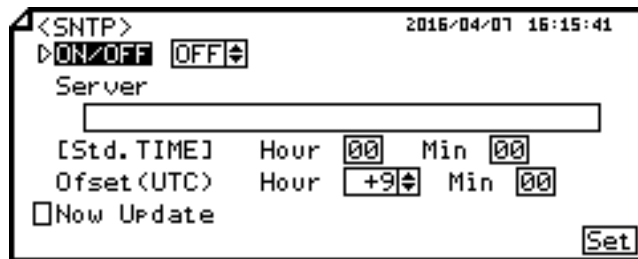
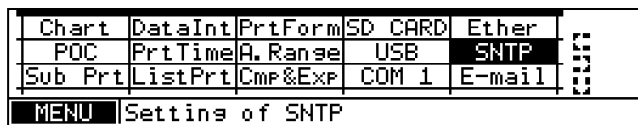

Note: Actual windows are separated. Use the ▲/▼ keys to scroll and continue settings

(1) Pressing the **MENU** key displays the menu window (list of setting items).

(2) Select “SNTP”.

(3) Move the cursor to the parameter to be set with the ▲/▼/◀/▶ keys.

(4) Press the **ENTER** key to make it available for setting and then select or enter a value.

(5) After completing the settings of this item, move the cursor to **Set**.

(6) Press the **ENTER** key to register the settings (when chart recording is ON, a setting change mark is printed). To cancel the settings, press the **ESC** key.

[List of SNTP setting parameters]

Parameter	Function	Default	Set value
ON/OFF	Set whether or not to use time setting function by SNTP	OFF	OFF (not used), ON (used)
Server	Set SNTP server name or IP address using 32 characters maximum	Not set	Set server name when DNS is used. Set server IP address when DNS is not used.
[Std.TIME]	Set reference time for query	00:00	00:00 to 23:59
Of set (UTC)	Set (time) difference between regional time of this unit is used and universal time.	+9:00	-18:59 to +18:59
Now Update	Obtain the time immediately after confirming settings by Set		Check the check box to enable the function.

13-6. E-mail Settings “E-mail”

Set E-mail transmission related parameters for Ethernet interface. E-mail can be sent when alarm or time event occurs. This section describes the things related to settings only. For general handling information, refer to the instruction manual for “Communication Interface” provided separately.

1. Account setup

Set up necessary items for E-mail transmission such as transmission server and mail account. Although E-mail receiving function is unavailable, POP3 server needs to be set since POP3 authentication is required in some cases at transmission.

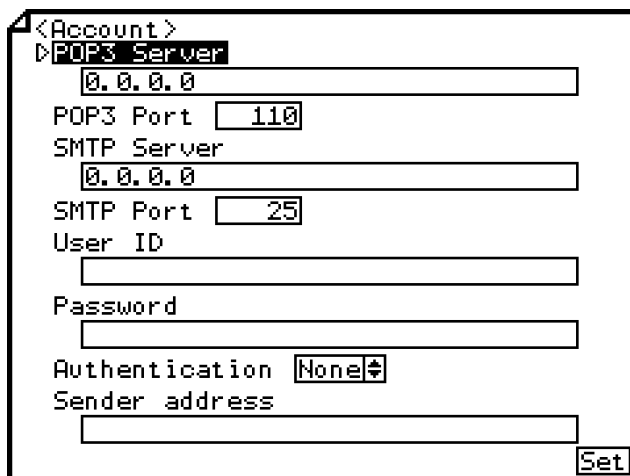
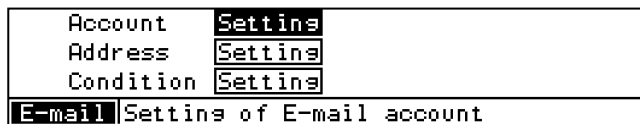
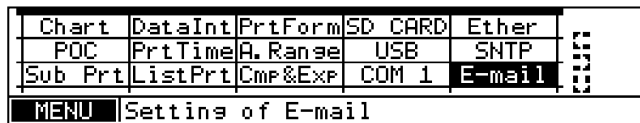

(1) Pressing the **MENU** key displays the menu window (list of setting items).

(2) Select “E-mail”.

(3) Make sure that the cursor is on **Setting** beside “Account”, and press the **ENTER** key.

(4) Move the cursor to the parameter to be set with the **▲/▼/◀/▶** keys.

(5) Press the **ENTER** key to make it available for setting and then select or enter a value.

(6) After completing the settings of this item, move the cursor to **Set**.

(7) Press the **ENTER** key to register the settings (when chart recording is ON, a setting change mark is printed). To cancel the settings, press the **ESC** key.

Note: Actual windows are separated. Use the **▲/▼** keys to scroll and continue settings

[List of E-mail Account setting parameters]

Parameter	Function	Default	Set value
POP3 Server	Set server name or IP address used for POP3 authentication using 32 characters maximum	Not set	Set server name when DNS is used. Set server IP address when DNS is not used.
POP3 Port	Set POP3 server port No.	110	Fixed to 110
SMTP Server	Set SMTP server name or IP address using 32 characters maximum	Not set	Set server name when DNS is used. Set server IP address when DNS is not used.
SMTP Port	Set SMTP server port No.	25	Fixed to 25
User ID	Set mail account using 32 characters maximum	Not set	
Password	Set mail password using 32 characters maximum	Not set	
Authentication	Select authentication type for accessing transmission server	None	None, POP, APOP
Sender address	Set sender mail address using 32 characters maximum	Not set	

2. Address setting

Set the destination address. E-mail can be sent to up to three different addresses.



- (1) Pressing the **MENU** key displays the menu window (list of setting items).

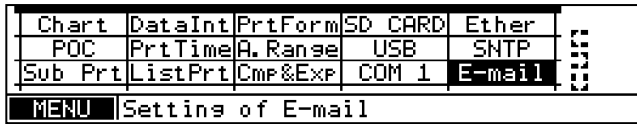

- (2) Select "E-mail".

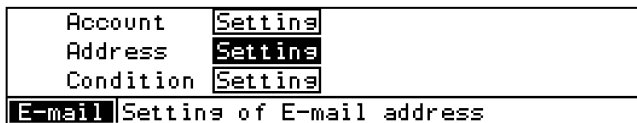

- (3) Move the cursor to **Setting** beside "Address" and press the **ENTER** key.

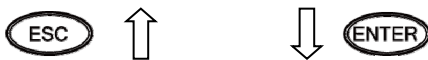

- (4) Move the cursor to the target address No. with the **▲/▼** keys and press the **ENTER** key. The cursor does not move to parameters other than No.

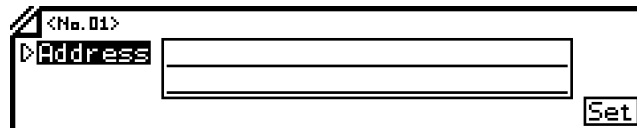

- (5) Press the **ENTER** key to make it available for setting and then enter a destination address.
- (6) After completing the setting of this item, move the cursor to **Set**.
- (7) Press the **ENTER** key to register the setting (when chart recording is ON, a setting change mark is printed). To cancel the setting, press the **ESC** key.

[E-mail Address setting parameter]

Parameter	Function	Default	Set value
Address	Set destination address for E-mail using 32 characters maximum	Not set	

3. Transmission condition setting

Set the E-mail transmission condition. E-mail can be sent at alarm activation (when alarm is activated on the specified channel), at set time (at every interval from reference time) or at occurrence of event like chart end (see "8-22. Fail Output Settings"). Up to six conditions can be registered.

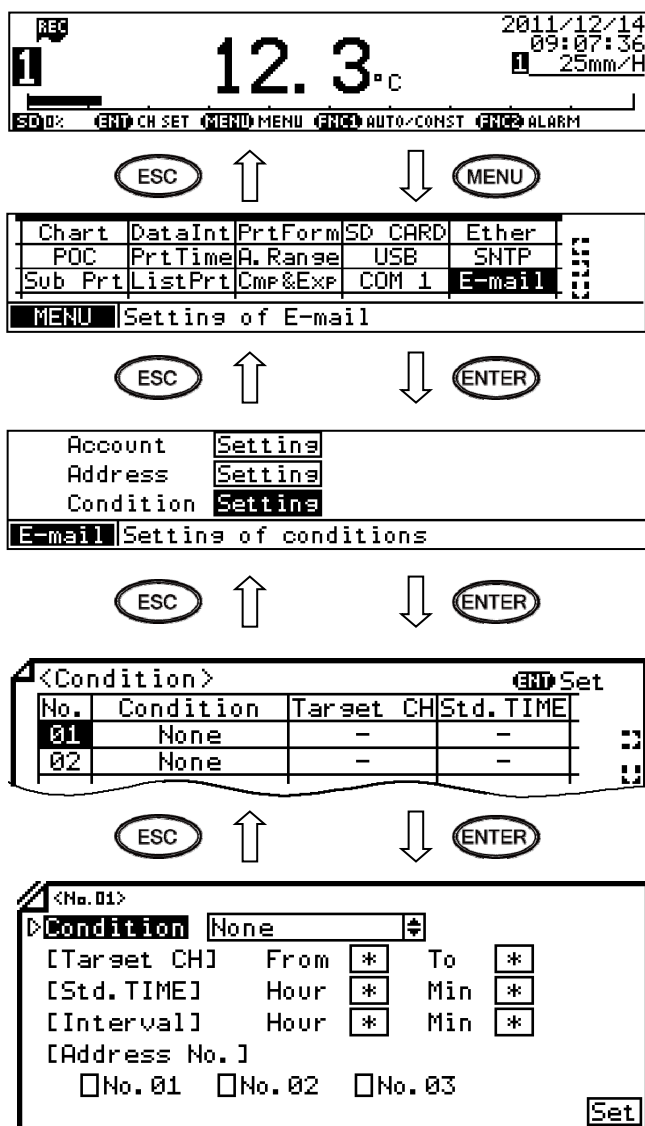

Note: Actual windows are separated. Use the ▲/▼ keys to scroll and continue settings

(1) Pressing the **MENU** key displays the menu window (list of setting items).

(2) Select "E-mail".

(3) Move the cursor to **Setting** beside "Condition" and press the **ENTER** key.

(4) Move the cursor to the target condition No. with the ▲/▼ keys and press the **ENTER** key. The cursor does not move to parameters other than No.

(5) Move the cursor to the parameter to be set with the ▲/▼/◀/▶ keys.

(6) Press the **ENTER** key to make it available for setting and then select or enter a value.

(7) After completing the settings of this item, move the cursor to **Set**.

(8) Press the **ENTER** key to register the settings (when chart recording is ON, a setting change mark is printed). To cancel the settings, press the **ESC** key.

[List of E-mail Condition setting parameters]

Parameter	Function	Default	Set value
Condition	Select E-mail transmission condition	None	None (not used), Alarm (at alarm activation), Interval (send measured value at fixed intervals), FailOut
[Target CH]	Set beginning and end of target CHs to send e-mail for alarm activation or measured value	*	1 to 4
[Std.TIME]	Set reference time for sending measured data	*	00:00 to 23:59
[Interval]	Set interval for sending measured data	*	00:00 to 24:59
[Address No.]	Select destination address for each condition		Select up to three addresses from those set in the previous section by checking desired address No.

Reference Interval setting

E-mail is sent at the following time: reference time + (interval x n) n = 0, 1, 2, 3...

Example: [Std.TIME] is set to "00:00" and [Interval] is set to "04:00"

E-mail will be sent at 00:00, 04:00, 08:00, 12:00, 16:00 and 20:00.

14. Specifications

■ Input specifications		Compressed/ expanded printing	Chart recording lower/upper limit is made non-linear, and specific chart recording lower/upper limit is shrunk or expanded.										
Measurement point	1 st pen, 2 nd pen, 3 rd pen and 4 th pen	Automatic range-shift	Recording range is shifted automatically to another set range when measured value exceeds the current range. Overlap function available										
Input type	[DC voltage] ±13.8mV, ±27.6mV, ±69.0mV, ±200mV, ±500mV, ±1V, ±5V, ±10V, ±20V, ±50V [DC current] Supported by additional shunt resistor (100Ω, 250Ω) [Thermocouple] K, E, J, T, R, S, B, N, U, L, W-WRe26, WRe5-WRe26, PtRh40-PtRh20, NiMo-Ni, CR-AuFe, PlatineI II, Au/Pt [Resistance thermometer] Pt100, old Pt100, JPt100, Pt50, Pt-Co	Periodic data printing	Digital printing is added to trace printing at (1) arbitrary intervals or (2) specified time. Printed items: Time, CH No., data and unit (1) Set interval and start time. Interval is limited by chart speed. (2) Set time for printing (24 points maximum)										
Measuring interval	Approx. 100mS	Data printing	Printing format differs depend on the chart speed. Printed items are time, CH No., data and unit Consecutive requests are limited to a certain number.										
Input resolution	Approx. 1/40000 or higher (converted into reference range)	Fixed time printing	Time and time line (Print interlocking with chart speed), Chart speed, chart recording higher and lower limit, CH No. & tag, and unit are printed Year/month/date is printed at every midnight. Tag is printed at the set time only.										
Input resistance	Thermocouple/DC voltage (±5V or lower range): 6MΩ or higher DC voltage (±10V or higher range): Approx. 1MΩ	Printing at power-on	Year/month/date and time are printed at power-on.										
Burnout	None/UP/DOWN can be selected for each input CH for thermocouple and resistance thermometer. These cannot be selected with DC voltage (±1V or higher range). Maximum time to detect burnout is about 1 second.	Alarm printing	Alarm activation time, CH No., alarm type and level are printed at alarm activation. Reset time, CH No., hyphen and alarm level are printed at alarm reset. Up to 48 data can be memorized.										
Allowable signal source resistance	[Thermocouple/DC voltage] Burnout disabled: 1kΩ or lower Burnout enabled: 100Ω or lower [Resistance thermometer] 10Ω or lower per wire, the same resistance for 3 wires	List printing	List printing is performed when required, interrupting trace printing. (1) "List 1": Major setting information Year/month/date, time, CH setting, recording setting and alarm setting (2) "List 2": Additional setting information Year/month/date, time, additional setting and optional setting (3) "List 3": List 1 + List 2 Year/month/date, time, List 1 + List 2 (4) Others Printing can be stopped. Consecutive requests are limited to a certain number.										
Maximum input voltage	Thermocouple/DC voltage (±5V or lower range): ±10V or lower DC voltage (±10V or higher range): ±60V or lower Resistance thermometer: ±6V or lower	Message printing	Printing is performed when required. Trace printing can be continued/interrupted. Linking to alarm activation/reset is possible. One message consists of up to 15 characters (alphabets, numbers, katakana, symbols, etc.). Up to 20 types can be registered. Consecutive requests are limited to a certain number.										
Measuring current	Resistance thermometer: 1mA ±20%	Calendar timer printing	Printing is performed with calendar timer ON and printing enabled. Trace printing is continued. Printed items: Year/month/date, time, calendar timer No. and message One message consists of up to 15 characters (alphabets, numbers, katakana, symbols, etc.), shared by message printing										
Maximum common mode voltage	30V AC/60V DC	Setting change mark	∟ is printed on the right side of chart when setting change occurs.										
Common mode rejection ratio	130dB or more (50/60Hz)	Operation recording	Remote contact ON/OFF status is recorded with straight line to specified area. Specified area: Within the range of 0 to 90% Up to 10 types can be recorded. * Only for the unit using remote contact and enabling operation recording.										
Series mode rejection ratio	50dB or more (50/60Hz)	Chart illumination	White LED ON/OFF/AUTO (turn OFF after 3-minute unused period can be set)										
Terminal board	Detachable	Chart end detection	Notified on the operation screen and status LED. Automatic recording stop (the rest operated normally)										
Accuracy rating	Refer to the tables of measuring range, rated accuracy and display resolution.	Pen up function	Performed automatically at recording stop and chart end. Manual pen up function is available.										
Reference junction compensation accuracy	Refer to the table of reference junction compensation accuracy.	Time axis synchronization (POC)	ON/OFF can be set at using 2 nd pen, 3 rd pen and 4 th pen.										
Temperature drift	±0.01%FS/°C Converted into reference electromotive force												
■ Recording specifications													
Recording system	Trace printing: disposable felt-tip pen Digital printing: dot type plotter pen												
Recording color	Trace printing <table border="1" style="margin-left: 20px;"> <tr> <td>CH</td> <td>1</td> <td>2</td> <td>3</td> <td>4</td> </tr> <tr> <td>Color</td> <td>Red</td> <td>Green</td> <td>Blue</td> <td>Brown</td> </tr> </table> *From far on the chart: CH1, CH2, Ch3, CH4 Digital recording/printing: Purple	CH	1	2	3	4	Color	Red	Green	Blue	Brown		
CH	1	2	3	4									
Color	Red	Green	Blue	Brown									
recording interval	Approx. 100mS												
Step response	90% /1.5sec												
Chart	Fan-fold type (Total width 200mm, total length 20m, recordable width 180mm)												
Recording deadband	0.2%												
Recording accuracy	Measurement accuracy ±0.3%												
Chart speed	Set arbitrarily from 1 to 600mm/h or 1to 200mm/m in 1mm interval. 12.5mm/h can be set exceptionally. Chart speed accuracy is in 0.1% of the chart scale.												
Chart fast-feed	Operated by FEED key Feed 0.1mm by one quick press of the key or feed continuously (approx. 600mm/min) by holding down the key.												
Display/recording ON/OFF	Select ON/OFF for trace printing to chart, digital printing to chart and recording to SD card for each CH.												
Subtract printing	Difference between reference CH value and measured value or between set value and measured value is printed.												
Zone printing	2/3/4 divisions												

■ Indication/display specifications		Exterior material	[Front] Door: Aluminum die-casting (ADC12) Glass: Soda glass [Rear] Case: Cold-rolled steel plate (SPCC)
Digital display	Full dot monochrome LCD 264 x 48 dots Display area 184 x 22mm White LED backlight (turned off after 3-minute unused period when selecting AUTO) Channel number: 2 digits Data display: 5 digits (+/- and decimal point excluded)	Exterior color	[Front] Door: Black (equivalent of Munsell N3.0) Glass: Clear and colorless [Rear] Case: Gray (equivalent of Munsell N7.0)
Analog indication	180mm LCD bar graph	Dimensions	288H x 288W x 220D (241D with the alarm output/remote contact unit or communication unit) * D indicates the panel depth.
Analog indication deadband	Undefined (no analog indication)	Terminal screw	Power terminal: M4.0 Protective conductor terminal: M4.0 Measuring input terminal: M3.5 Alarm output terminal: M3.5 Remote contact terminal: M3.5 Communications terminal: M3.0
Status LED	(1) REC: Green LED OFF: Recording stopped Flash: Chart end detecting ON: Recording (2) CARD: Green LED OFF: No card inserted Flash: Card being accessed ON: Card inserted (3) ALM: Red LED OFF: All alarm OFF Flash: Any alarm ON notification	Weight	1 st pen specification: approx.: 7.1g (with full options) 2 nd pen specification: approx.: 7.3g (with full options) 3 rd pen specification: approx.: 7.6g (with full options) 4 th pen specification: approx.: 7.8g (with full options)
Operation/set keys	FUNC1: Function switch 1 FUNC2: Function switch 2 ENTER: Register settings MENU: Display settings ESC: Cancel settings ▲: Forward ▼: Reverse ◀: Move left ▶: Move right REC: Recording start/stop FEED: Chart fast feed DATAP: Data print	Mounting	Panel mounting Mounting brackets attached to the right and left sides
Front engineering port	Mini-USB port	Panel cutout size	281 x 281
■ General specifications		CE / UKCA marking	EN61326-1 EN61010-1 EN61010-2-030 EN IEC63000 * Under EMC test condition, variation in indication value $\pm 20\%$ or $\pm 2mV$ at maximum, whichever is larger may occur.
Rated power voltage	General specification: 100 to 240V AC	Environmental consideration	RoHS compliant EU new battery directive compliant PFOS compliant CHINO's environmentally-conscious design compliant
Rated power frequency	General specification: 50/60Hz	Packing material	Environmentally-friendly materials used
Power consumption	1 st pen specification: general specification, MAX 37VA 100V AC balanced*: 16VA 240V AC balanced*: 22VA 2 nd pen specification: general specification, MAX 38VA 100V AC balanced*: 17VA 240V AC balanced*: 23VA 3 rd pen specification: general specification, MAX 39VA 100V AC balanced*: 18VA 240V AC balanced*: 24VA 4 th pen specification: general specification, MAX 40VA 100V AC balanced*: 18VA 240V AC balanced*: 25VA * Balanced: Only recording. Alarm and communication are not operated.	■ Reference operating condition	
Memory protection	Set contents and pen type POC data maintained by nonvolatile RAM. Clock data maintained by lithium battery. (Under the normal operating condition 21 to 25°C and 45 to 55% RH, data saved for more than 10 years with 8-hour or more operation per day.) (Alarm message displayed when battery level drops.)	Ambient temperature	23°C $\pm 2^\circ\text{C}$
Clock accuracy	± 2 minutes in 30 days (under reference operating condition, error caused by power ON/OFF excluded)	Ambient humidity	55%RH $\pm 10\%$ (non-condensing)
Insulation resistance	Primary terminal – protective conductor terminal: 20M Ω or more (500V DC) Secondary terminal – protective conductor terminal: 20M Ω or more (500V DC) Primary terminal – secondary terminal: 20M Ω or more (500V DC) * Primary terminal: General power terminal (100 to 240V), alarm output terminal of mechanical relay "a" and mechanical relay "c" Secondary terminal: All terminals other than primary and protective conductor terminals Protective terminal is connected to the chassis metal part.	Power voltage	General specification: 100V AC $\pm 1\%$
Withstand voltage	Primary terminal – protective conductor terminal: 1500V AC (one minute) Secondary terminal – protective conductor terminal: 500V AC (one minute) Primary terminal – secondary terminal: 1500V AC (one minute) * Primary terminal: General power terminal (100 to 240V), alarm output terminal of mechanical relay "a" and mechanical relay "c" Secondary terminal: All terminals other than primary and protective conductor terminals Protective terminal is connected to the chassis metal part.	Power frequency	General specification: 50/60Hz $\pm 0.5\%$
		Mounting posture	Back and forth $\pm 0^\circ$, left and right $\pm 0^\circ$
		Mounting condition	Single panel mounting (space required around)
		Altitude	2000m or lower
		Vibration	0 m/s ²
		Impact	0 m/s ²
		Wind	None
		External noise	None
		Warm-up time	30 minutes or more
		■ Normal operating condition	
		Ambient temperature	0 to 50°C (20 to 65%RH, non-condensing)
		Ambient humidity	20 to 80%RH, non-condensing (5 to 45°C)
		Power voltage	General specification: 100 to 240V AC $\pm 10\%$
		Power frequency	General specification: 50/60Hz $\pm 2\%$
		Mounting posture	Forward tilt 0°, backward tilt 0 to 30°, left and right 0 to 10°
		Mounting condition	Single panel mounting (space required above and below)
		Altitude	2000m or lower
		Vibration	2.0m/s ² or less
		Impact	0m/s ²
		Wind	None
		External noise	None
		Temperature variation	10°C/h or less
		■ Transportation condition	
		Ambient temperature and humidity	-10 to 60°C 5 to 90%RH (non-condensing)
		Vibration	4.9m/s ² or less (10 to 60Hz)
		Impact	392m/s ² or less
		* These conditions are set assuming that the unit is packed in a similar way to that at shipment.	
		■ Storage condition	
		Ambient temperature and humidity	-10 to 40°C, 5 to 90%RH (non-condensing) 40 to 60°C, 5 to 65%RH (non-condensing) (10 to 30°C for a long-term storage)
		Vibration	0m/s ² (10 to 60Hz)
		Impact	0m/s ²
		* These conditions are set assuming that the unit is packed in a similar way to that at shipment. Re-adjustment may be required.	

■ Measuring range, rated accuracy and display resolution

Input type		Measuring range	Reference range	Display resolution	Rated accuracy	Exception
DC voltage	DC (mV)	-13.80 to 13.80mV	±13.8mV	10µV	±0.1%FS ±1digit	
		-27.60 to 27.60mV	±27.6mV	10µV		
		-69.00 to 69.00mV	±69.0mV	10µV		
		-200.0 to 200.0mV	±200mV	100µV		
		-500.0 to 500.0mV	±500mV	100µV		
	DC (V)	-1.00 to 1.00V	±1V	10mV	±0.1%FS ±1digit	
		-5.00 to 5.00V	±5V	10mV		
		-10.00 to 10.00V	±10V	10mV		
		-20.00 to 20.00V	±20V	10mV		
		-50.00 to 50.00V	±50V	10mV		
Thermocouple	K	-200.0 to 300.0°C	±13.8mV	0.1°C	±0.1%FS ±1digit	-200 to 0°C: ±0.2%FS ±1digit or equivalent of 70µV, whichever is larger
		-200.0 to 600.0°C	±27.6mV	0.1°C		
		-200 to 1370°C	±69.0mV	1°C		
	E	-200.0 to 200.0°C	±13.8mV	0.1°C	±0.1%FS ±1digit	-200 to 0°C: ±0.2%FS ±1digit or equivalent of 70µV, whichever is larger
		-200.0 to 350.0°C	±27.6mV	0.1°C		
		-200 to 900°C	±69.0mV	1°C		
	J	-200.0 to 250.0°C	±13.8mV	0.1°C	±0.1%FS ±1digit	-200 to 0°C: ±0.2%FS ±1digit or equivalent of 70µV, whichever is larger
		-200.0 to 500.0°C	±27.6mV	0.1°C		
		-200 to 1200°C	±69.0mV	1°C		
	T	-200.0 to 250.0°C	±13.8mV	0.1°C	±0.1%FS ±1digit	-200 to 0°C: ±0.2%FS ±1digit
		-200.0 to 400.0°C	±27.6mV	0.1°C		
	R	0 to 1200°C	±13.8mV	1°C	±0.1%FS ±1digit	0 to 400°C: ±0.2%FS ±1digit
		0 to 1760°C	±27.6mV	1°C		
	S	0 to 1300°C	±13.8mV	1°C	±0.1%FS ±1digit	0 to 400°C: ±0.2%FS ±1digit
		0 to 1760°C	±27.6mV	1°C		
	B	0 to 1820°C	±13.8mV	1°C	±0.1%FS ±1digit	0 to 400°C: undefined 400 to 800°C: ±0.2%FS ±1digit
	N	-200.0 to 400.0°C	±13.8mV	0.1°C	±0.1%FS ±1digit	-200 to 0°C: ±0.2%FS ±1digit or equivalent of 70µV, whichever is larger
		-200.0 to 750.0°C	±27.6mV	0.1°C		
		-200 to 1300°C	±69.0mV	1°C		
	U	-200.0 to 250.0°C	±13.8mV	0.1°C	±0.1%FS ±1digit	-200 to 0°C: ±0.2%FS ±1digit or equivalent of 70µV, whichever is larger
		-200.0 to 500.0°C	±27.6mV	0.1°C		
		-200.0 to 600.0°C	±69.0mV	0.1°C		
	L	-200.0 to 250.0°C	±13.8mV	0.1°C	±0.1%FS ±1digit	-200 to 0°C: ±0.2%FS ±1digit or equivalent of 70µV, whichever is larger
		-200.0 to 500.0°C	±27.6mV	0.1°C		
		-200 to 900°C	±69.0mV	1°C		
	W-WRe26	0 to 2315°C	±69.0mV	1°C	±0.15%FS ±1digit	0 to 400°C: ±0.3%FS ±1digit
	WRe5-WRe26	0 to 2315°C	±69.0mV	1°C	±0.2%FS ±1digit	
NiMo-Ni	0.0 to 290.0°C	±13.8mV	0.1°C	±0.2%FS ±1digit		
	0.0 to 600.0°C	±27.6mV	0.1°C			
	0 to 1310°C	±69.0mV	1°C			
Platinel II	0.0 to 350.0°C	±13.8mV	0.1°C	±0.15%FS ±1digit		
	0.0 to 650.0°C	±27.6mV	0.1°C			
	0 to 1390°C	±69.0mV	1°C			
PtRh40-PtRh20	0 to 1880°C	±13.8mV	1°C	±0.2%FS ±1digit	0 to 400°C: ±1.5%FS ±1digit 400 to 800°C: ±0.8%FS ±1digit	
CR-AuFe	0.0 to 280.0K	±6.9mV	0.1K	±0.2%FS ±1digit	0 to 20K: ±0.5%FS ±1digit 20 to 50K: ±0.3%FS ±1digit	
Au/Pt	0.0 to 1000.0°C	±27.6mV	0.1°C	±0.2%FS ±1digit		

Input type		Measuring range	Reference range	Display resolution	Rated accuracy	Exception
Resistance thermometer	Pt100	-140.0 to 150.0°C	160Ω	0.1°C	±0.1%FS ±1digit	
		-200.0 to 300.0°C	220Ω	0.1°C		
		-200.0 to 649.0°C	340Ω	0.1°C		
		-200.0 to 850.0°C	400Ω	0.1°C		
	Old Pt100	-140.0 to 150.0°C	160Ω	0.1°C	±0.1%FS ±1digit	
		-200.0 to 300.0°C	220Ω	0.1°C		
		-200.0 to 649.0°C	340Ω	0.1°C		
	JPt100	-140.0 to 150.0°C	160Ω	0.1°C	±0.1%FS ±1digit	
		-200.0 to 300.0°C	220Ω	0.1°C		
		-200.0 to 649.0°C	340Ω	0.1°C		
	Pt50	-200.0 to 649.0°C	220Ω	0.1°C	±0.1%FS ±1digit	
	Pt-Co	4.0 to 374.0K	220Ω	0.1K	±0.15%FS ±1digit	4 to 20K: ±0.5%FS ±1digit 20 to 50K: ±0.3%FS ±1digit

- * Measuring range conversion accuracy under reference operating condition.
Reference junction compensation accuracy is added for thermocouple input.
- * Under EMC test condition, variation in indication value ±20% or ±2mV at maximum, whichever is larger may occur.

K, E, J, T, R, S, B, N: IEC584 (1977 and 1982), JIS C 1602-1995, JIS C 1605-1995
W-WRe26, NiMo-Ni, Platinel II, PtRh40-PtRh20, CR-AuFe, Au/Pt: ASTM E1751
WRe5-WRe26: ASTM E988
U, L: DIN43710-1985
Pt100: IEC751 (1995), JIS C 1604-1997
Old Pt100: IEC751 (1983), JIS C 1604-1989, JIS C 1606-1989
JPt100: JIS C 1604-1981, JIS C 1606-1986
Pt50: JIS C 1604-1981
Pt-Co: CHINO

■ Reference junction compensation accuracy

Input type	Reference junction compensation accuracy	
	Ambient temperature: 23°C±10°C	Ambient humidity: range except for description on the left
K, E, J, T, N Platinel II	±0.5°C or equivalent of 20μV, whichever is larger.	±0.1°C or equivalent of 40μV, whichever is larger.
Except for above description	±1.0°C or equivalent of 40μV, whichever is larger.	±2.0°C or equivalent of 80μV, whichever is larger.

■ Plus or minus 1 digit during scaling

Plus or minus 1 digit is the scaling value corresponding display resolution of the measuring range.
For example, when scaling "±10" for ±500mV range, ±1 digit = ±0.002.

Disposal of Electrical and Electronic Equipment (for Environmental Protection)

This is an industrial product subject to the WEEE Directive.
Do not dispose of electrical and electronic equipment in the same way as household waste.
Old products contain valuable raw materials and must be returned to an authorized collection point for correct disposal or recycling.



Revision History of CP-UM-5799E

Printed	Edn.	Revised pages	Description
Dec. 2014	1		
June 2017	2	3 18 21 121 121 121 End	4. Change lengths of the chart paper of "Remarks" 2), (2) Change 13 pages → 4-3. Wiring, 2. Precautions on wiring 4), (8) Change the sentences CE marking : Erase (conformity pending) CE marking : Add EN61010-2-030 Erase UL and c-UL Change AAS-511A-014-04 to AAS-511A-014-06
Aug. 2019	3	1 3 4 5 8 15 16 18 20 26 29 32 34 39 43 44 45 46 83 84 85 86 88 97 100 101 101 111 120 124 125 End	Change instruction manual labels → instruction manual, labels and markings Add *When using recording paper other than the genuine chart, operation is not guaranteed. Change sentence of 2-3. inside the table Add 9. Do not look at light directly Add overvoltage in Industrial environment overvoltage 3. 2) Add (AWG20 to 16) Change wire diameter 2mm ² or more → Copper cable with AWG 20 to 16 (green/yellow) Add Maximum temporary overvoltage: ±60VDC inside the caution Add Do not use the instrument for measurements on mains circuits. inside the warning 2) Add Use the cable of AWG 20 to 16. Add and industrial environment should be overvoltage category I. inside the warning Change 1390VAC → 1500VAC inside the warning Add only the circuit of secondary side which is reinforced from primary side or treated double insulation is able to be connected. inside the warning Add Example of connection of devices (one-to-one connection) Add Note 2 Chart feeding holder, (Metal part), (Resin part)) Add 6-2. Basic Operation 2. Language setting Add Note 2 Ink bleeding on the chart Change * Digital display/printing is available for measurement value out of the measuring range if it is within ±10% of the span. Add numbers to the notes Add 10) Recording deadband Add actual window image Add D.Band in the table Change and Add If using SD card other than the one provided by Azbil (sold separately), data may be damaged and lost. Add actual window image Delete Note 4 Measured data save Add overwrite in the table Add Note Overwrite mode of measured data Add Note Also, the file is divided if device setting or date and time setting is changed. Add number to the note, 3 Add Note 2 This cannot initialize the adjustment data (zero/span calibration) and soft dip information. Add 8-28. Soft Dip Switch Settings "SoftDip" Add Actual soft dip SW window Change data → date of U03 to U05, and U11 in the table Add U13 and U14 in the table Change Note Saving setting parameters to the SD card and loading setting paramters form the SD card Add Caution Do not lubricate the mechanical section such as the main shaft and gear. Add Ofset (UTC) in the table Change burnout Change CE marking Change AAS-511A-014-06 to AAS-511A-014-10

Feb. 2021	4	39 End	4., * Change $\pm 10\%$ \rightarrow $\pm 5\%$ Delete MEMO page
Jun. 2022	5	Cover 1 2 3 5 12 125 127 Back cover	Change "SR200" to "Model SR200". Change sentence of "Thank you for purchasing...". Change "SR series" \rightarrow "SR200". Delete "or damage" from (1) and (2) in "Product warranty scope". Removed "Windows XP, Windows Vista" from Trademark and added "Windows 8.1, Windows 10". Add date of manufacture "YYYYMMDD" to the Model code label. Change of bracket "2 (1 set)" to "1 set". Delete "81446641-001". Delete "(Recycled pulp combination ratio is 20% or more.)". Change sentence of 6. Installing the safety device. Add the Caution "Caution at removing and replacing" Change cell name "CE marking" to "CE / UKCA marking" and add "EN IEC 63000" as standard-compliant. Add notice in relation to WEEE Directive. Change (09) \rightarrow (11) Change URL. Delete (K).

Terms and Conditions

We would like to express our appreciation for your purchase and use of Azbil Corporation's products.

You are required to acknowledge and agree upon the following terms and conditions for your purchase of Azbil Corporation's products (system products, field instruments, control valves, and control products), unless otherwise stated in any separate document, including, without limitation, estimation sheets, written agreements, catalogs, specifications and instruction manuals.

1. Warranty period and warranty scope

1.1 Warranty period

Azbil Corporation's products shall be warranted for one (1) year from the date of your purchase of the said products or the delivery of the said products to a place designated by you.

1.2 Warranty scope

In the event that Azbil Corporation's product has any failure attributable to azbil during the aforementioned warranty period, Azbil Corporation shall, without charge, deliver a replacement for the said product to the place where you purchased, or repair the said product and deliver it to the aforementioned place. Notwithstanding the foregoing, any failure falling under one of the following shall not be covered under this warranty:

- (1) Failure caused by your improper use of azbil product (noncompliance with conditions, environment of use, precautions, etc. set forth in catalogs, specifications, instruction manuals, etc.);
- (2) Failure caused for other reasons than Azbil Corporation's product;
- (3) Failure caused by any modification or repair made by any person other than Azbil Corporation or Azbil Corporation's subcontractors;
- (4) Failure caused by your use of Azbil Corporation's product in a manner not conforming to the intended usage of that product;
- (5) Failure that the state-of-the-art at the time of Azbil Corporation's shipment did not allow Azbil Corporation to predict; or
- (6) Failure that arose from any reason not attributable to Azbil Corporation, including, without limitation, acts of God, disasters, and actions taken by a third party.

Please note that the term "warranty" as used herein refers to equipment-only-warranty, and Azbil Corporation shall not be liable for any damages, including direct, indirect, special, incidental or consequential damages in connection with or arising out of Azbil Corporation's products.

2. Ascertainment of suitability

You are required to ascertain the suitability of Azbil Corporation's product in case of your use of the same with your machinery, equipment, etc. (hereinafter referred to as "Equipment") on your own responsibility, taking the following matters into consideration:

- (1) Regulations and standards or laws that your Equipment is to comply with.
- (2) Examples of application described in any documents provided by Azbil Corporation are for your reference purpose only, and you are required to check the functions and safety of your Equipment prior to your use.
- (3) Measures to be taken to secure the required level of the reliability and safety of your Equipment in your use

Although azbil is constantly making efforts to improve the quality and reliability of Azbil Corporation's products, there exists a possibility that parts and machinery may break down. You are required to provide your Equipment with safety design such as fool-proof design,*1 and fail-safe design*2 (anti-flame propagation design, etc.), whereby preventing any occurrence of physical injuries, fires, significant damage, and so forth. Furthermore, fault avoidance,*3 fault tolerance,*4 or the like should be incorporated so that the said Equipment can satisfy the level of reliability and safety required for your use.

*1. A design that is safe even if the user makes an error.

*2. A design that is safe even if the device fails.

*3. Avoidance of device failure by using highly reliable components, etc.

*4. The use of redundancy.

3. Precautions and restrictions on application

3.1 Restrictions on application

Please follow the table below for use in nuclear power or radiation-related equipment.

	Nuclear power quality*5 required	Nuclear power quality*5 not required
Within a radiation controlled area*6	Cannot be used (except for limit switches for nuclear power*7)	Cannot be used (except for limit switches for nuclear power*7)
Outside a radiation controlled area*6	Cannot be used (except for limit switches for nuclear power*7)	Can be used

*5. Nuclear power quality: compliance with JEAG 4121 required

*6. Radiation controlled area: an area governed by the requirements of article 3 of "Rules on the Prevention of Harm from Ionizing Radiation," article 2 2 4 of "Regulations on Installation and Operation of Nuclear Reactors for Practical Power Generation," article 4 of "Determining the Quantity, etc., of Radiation-Emitting Isotopes," etc.

*7. Limit switch for nuclear power: a limit switch designed, manufactured and sold according to IEEE 382 and JEAG 4121.

Any Azbil Corporation's products shall not be used for/with medical equipment.

The products are for industrial use. Do not allow general consumers to install or use any Azbil Corporation's product. However, azbil products can be incorporated into products used by general consumers. If you intend to use a product for that purpose, please contact one of our sales representatives.

3.2 Precautions on application

you are required to conduct a consultation with our sales representative and understand detail specifications, cautions for operation, and so forth by reference to catalogs, specifications, instruction manual, etc. in case that you intend to use azbil product for any purposes specified in (1) through (6) below. Moreover, you are required to provide your Equipment with fool-proof design, fail-safe design, anti-flame propagation design, fault avoidance, fault tolerance, and other kinds of protection/safety circuit design on your own responsibility to ensure reliability and safety, whereby preventing problems caused by failure or nonconformity.

- (1) For use under such conditions or in such environments as not stated in technical documents, including catalogs, specification, and instruction manuals
- (2) For use of specific purposes, such as:
 - * Nuclear energy/radiation related facilities
[When used outside a radiation controlled area and where nuclear power quality is not required]
[When the limit switch for nuclear power is used]
 - * Machinery or equipment for space/sea bottom
 - * Transportation equipment
[Railway, aircraft, vessels, vehicle equipment, etc.]
 - * Antidisaster/crime-prevention equipment
 - * Burning appliances
 - * Electrothermal equipment
 - * Amusement facilities
 - * Facilities/applications associated directly with billing
- (3) Supply systems such as electricity/gas/water supply systems, large-scale communication systems, and traffic/air traffic control systems requiring high reliability
- (4) Facilities that are to comply with regulations of governmental/public agencies or specific industries
- (5) Machinery or equipment that may affect human lives, human bodies or properties
- (6) Other machinery or equipment equivalent to those set forth in items (1) to (5) above which require high reliability and safety

4. Precautions against long-term use

Use of Azbil Corporation's products, including switches, which contain electronic components, over a prolonged period may degrade insulation or increase contact-resistance and may result in heat generation or any other similar problem causing such product or switch to develop safety hazards such as smoking, ignition, and electrification. Although acceleration of the above situation varies depending on the conditions or environment of use of the products, you are required not to use any Azbil Corporation's products for a period exceeding ten (10) years unless otherwise stated in specifications or instruction manuals.

5. Recommendation for renewal

Mechanical components, such as relays and switches, used for Azbil Corporation's products will reach the end of their life due to wear by repetitious open/close operations.

In addition, electronic components such as electrolytic capacitors will reach the end of their life due to aged deterioration based on the conditions or environment in which such electronic components are used. Although acceleration of the above situation varies depending on the conditions or environment of use, the number of open/close operations of relays, etc. as prescribed in specifications or instruction manuals, or depending on the design margin of your machine or equipment, you are required to renew any Azbil Corporation's products every 5 to 10 years unless otherwise specified in specifications or instruction manuals. System products, field instruments (sensors such as pressure/flow/level sensors, regulating valves, etc.) will reach the end of their life due to aged deterioration of parts. For those parts that will reach the end of their life due to aged deterioration, recommended replacement cycles are prescribed. You are required to replace parts based on such recommended replacement cycles.

6. Other precautions

Prior to your use of Azbil Corporation's products, you are required to understand and comply with specifications (e.g., conditions and environment of use), precautions, warnings/cautions/notices as set forth in the technical documents prepared for individual Azbil Corporation's products, such as catalogs, specifications, and instruction manuals to ensure the quality, reliability, and safety of those products.

7. Changes to specifications

Please note that the descriptions contained in any documents provided by azbil are subject to change without notice for improvement or for any other reason. For inquires or information on specifications as you may need to check, please contact our branch offices or sales offices, or your local sales agents.

8. Discontinuance of the supply of products/parts

Please note that the production of any Azbil Corporation's product may be discontinued without notice. After manufacturing is discontinued, we may not be able to provide replacement products even within the warranty period.

For repairable products, we will, in principle, undertake repairs for five (5) years after the discontinuance of those products. In some cases, however, we cannot undertake such repairs for reasons, such as the absence of repair parts. For system products, field instruments, we may not be able to undertake parts replacement for similar reasons.

9. Scope of services

Prices of Azbil Corporation's products do not include any charges for services such as engineer dispatch service. Accordingly, a separate fee will be charged in any of the following cases:

- (1) Installation, adjustment, guidance, and attendance at a test run
- (2) Maintenance, inspection, adjustment, and repair
- (3) Technical guidance and technical education
- (4) Special test or special inspection of a product under the conditions specified by you

Please note that we cannot provide any services as set forth above in a nuclear energy controlled area (radiation controlled area) or at a place where the level of exposure to radiation is equivalent to that in a nuclear energy controlled area.



Specifications are subject to change without notice. (11)

[Selling agency]

Azbil Corporation
Advanced Automation Company

1-12-2 Kawana, Fujisawa
Kanagawa 251-8522 Japan
URL: <https://www.azbil.com>

[Manufacturer]

CHINO Corporation
32-8 KUMANO-CHO, ITABASHI-KU,
TOKYO 173-8632 JAPAN

1st edition: Dec. 2014
5th edition: Jun. 2022